



S E R I E S
MUSIC PROCESSOR

271006

OWNER'S MANUAL



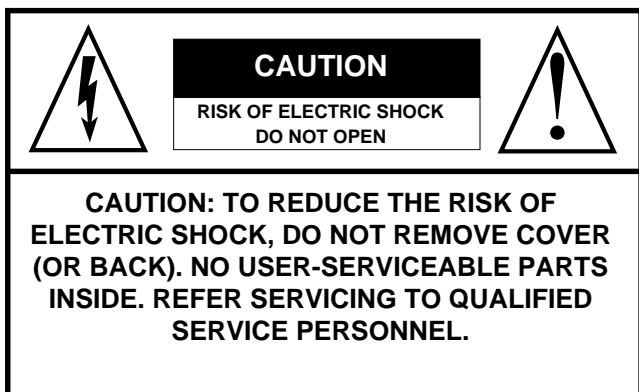

EXPLANATION OF GRAPHIC SYMBOLS:



The lightning flash with arrowhead symbol, within an equilateral triangle, is intended to alert the user to the presence of uninsulated "dangerous voltage" within the product's enclosure that may be of sufficient magnitude to constitute a risk of electric shock to persons.



The exclamation mark within an equilateral triangle is intended to alert the user to the presence of important operating and maintenance (servicing) instructions in the literature accompanying the product.

IMPORTANT SAFETY AND INSTALLATION INSTRUCTIONS

INSTRUCTION PERTAINING TO A RISK OF FIRE, ELECTRIC SHOCK, OR INJURY TO PERSONS.

WARNING - When using electric products, basic precautions should always be followed, including the following:

1. Read all the Safety and Installation instructions and explanations of Graphic Symbols before using the product .
2. This product must be earthed. If it should malfunction or breakdown, grounding provides a path of least resistance for electric current to reduce the risk of electric shock. This product is equipped with a cord having an equipment-grounding conductor and a grounding plug. The plug must be plugged into an appropriate outlet that is properly installed and earthed in accordance with all local codes and ordinances.

DANGER - Improper connection of the equipment-grounding conductor can result in a risk of electric shock. Check

with a qualified electrician or serviceman if you are in doubt as to whether the product is properly grounded. Do not modify the plug provided with the product - if it will not fit the outlet, have a proper outlet installed by a qualified electrician.

3. To reduce the risk of injury, close supervision is necessary when this product is used near children.
4. Do not use this product near water - for example, near a bathtub, washbowl, kitchen sink, in a wet basement, or near a swimming pool or the like.
5. This product should only be used by a stand or cart that is recommended by the manufacturer.
6. This product, either alone or in combination with an amplifier and headphones or speakers, may be capable of producing sound levels that could cause permanent hearing loss. Do not operate for a long period of time at a high volume level or at a level that is uncomfortable. If you experience any hearing loss or ringing in the ears, you should consult an audiologist.
7. This product should be located so that its location or position does not interfere with its proper ventilation.
8. This product should be located away from heat sources such as radiators, heat registers, or other products that produce heat.
9. The product should be connected to a power supply only of the type described in the operating instructions or as marked on the product.
10. This product may be equipped with a polarized line plug (one blade wider than the other). This is a safety feature. If you are unable to insert the plug into the outlet, contact an electrician to replace your obsolete outlet. Do not defeat the safety purpose of the plug.
11. The power-supply cord of the product should be unplugged from the outlet when left unused for a long period of time. When unplugging the power supply cord, do not pull on the cord, but grasp it by the plug.
12. Care should be taken so that objects do not fall and liquids are not spilled into the enclosure through openings.
13. The product should be serviced by qualified service personnel when:
 - A. The power-supply cord or the plug has been damaged; or
 - B. Objects have fallen, or liquid has been spilled into the product; or
 - C. The products has been exposed to rain; or
 - D. The product does not appear to be operating normally or exhibits a marked change in performance; or
 - E. The product has been dropped, or the enclosure damaged.
14. Do not attempt to service the product beyond that described in the user-maintenance instructions. All other servicing should be referred to qualified service personnel.
15. **WARNING** - Do not place objects on product power cord or place it in a position where anyone could trip over, walk on or roll anything over it. Do not allow the product, or its bench, or its pedal board to rest on or to be installed over power cords of any type. Improper installations of this type create the possibility of fire hazard and/or personal injury.
16. Electromagnetic interference (RFI). This electronic product utilizes digital sampled wave processing technology (S.W.P.) that may adversely affect radio/tv reception. Read FCC information inside back cover for additional information.

SAVE THESE INSTRUCTIONS

S **SERIES**
MUSICPROCESSORS

OWNER'S MANUAL

Registered trademarks cited in this publication

Amiga is a registered trademark of Commodore/Amiga, Inc. Akai and Akai S1000 are registered trademarks of Akai Professional. Apple File Exchange and Macintosh are registered trademarks of Apple Computer, Inc. Atari and Atari ST are registered trademarks of the Atari Corporation. Sound Designer is a registered trademark of DigiDesign, Inc. Notator and Notator Logic are registered trademarks of Emagic GmbH. AccesPC is a registered trademark of Insignia Solutions, Inc. MS-DOS and Wave are registered trademarks of the Microsoft Corporation. Avalon and Cubase are registered trademarks of Steinberg Research GmbH. Sample Vision is a registered trademark of Turtle Beach Systems, Inc. All other trademarks cited are the property of the respective manufacturer.

The information contained in this publication has been carefully prepared and checked. However, no responsibility will be taken for eventual errors. All rights are reserved and this document may not be copied, photocopied or reproduced in part or in whole without prior consent from **Generalmusic S.p.A.** **Generalmusic S.p.A.** reserves the right to apply whatever aesthetic, design or functional modifications are considered necessary to any of their products without prior notice. **Generalmusic S.p.A.** assumes no responsibility for the use or application of the products or circuits described herein.

© 1994 by *Generalmusic S.p.A.* All rights reserved.



This symbol, silkscreened on the instrument's back panel, is an indication that the S Series unit incorporates two rechargeable Ni/Cd (Nickel-Cadmium) batteries which are recharged while the instrument is in use. These batteries maintain data intact (when the instrument is off) in the Ram (if installed), and any user-programmed data in EDIT GENERAL (date, time, footswitch polarity and operating status, General MIDI compatibility, Dynamic and Aftertouch sensitivity in S2/S3 and the Sound Test note in S2R).

SUBJECT INDEX

This index lists all the subjects discussed in the manual. Each subject shows the section and relative chapter where the subject appears.

Abbreviations

U/S	User Interface/Selection	P	Practical guide
ST	SampleTranslator	R	Reference

For example, “Song-load from disk, P2, R11” shows that the description of the procedure to load a Song from disk is described in the *Practical Guide* section, chapter 2 and also in the *Reference* section, chapter 11.

Song

- load from disk	P2, R11
- load as Midi-file	P4, R11
- save to disk	P3, R11
- save as Midi-file	P4, R11
- erase from memory	P7, R9
- copy to another Bank/Song	R16
- create a Bank/Song	P7, R8
- Edit Song	R9

Sequencer

- controls	P6, R8
- select a Song	U/S, P6, R8
- playback a Song	P6, R8
- record a Song	P9, R8

Performance

- how to programme a Performance	P8, R3
- programming the tracks	P8, R4
- viewing options of the tracks	U/S, R1

Sound

- Sound Library	
<i>load from disk (as a Sound Library Setup)</i>	P2, R11
<i>save to disk (as a Sound Library Setup)</i>	P3, R11
<i>import a Song from disk</i>	R12
<i>organisation</i>	R12
- selection (and assignment to a track)	
<i>from the control panel</i>	U/S
<i>via Midi</i>	P12
- Edit Sound	
<i>select the type of Sound</i>	R5
<i>select the Waveform</i>	R5
<i>creat a Waveform</i>	ST, R6
<i>definition of an Envelope</i>	P11
<i>definition of Tracking</i>	P11
- Real time Sound editing	P10
- Edit Sound via MIDI	P14

Effects

- Effects Bypass	U/S
- Effects Libraries	
<i>loading from disk (as an Effects Libraries Setup)</i>	P2, R11
<i>save to disk (as an Effects Libraries Setup)</i>	P3, R11
<i>organisation</i>	R13
- Edit Effects	R14
- assignment to the Performance	P8, R13
- activation of the tracks	P8, R13
- selecting the Effects via Midi	P13
- modifying the Effects via Midi	P13

Drumkits & Sound Patch

- definition and editing	R7
--------------------------	----

Midi

- assigning the Midi channels to the tracks	R4
- difinition and programming the Midi-Common	R10
- Midi-Merge	R10
- General Midi	P4, R10
- communicating with an external sequencer	P15

Pedals, Footswitches

- assigning the functions	P8, R3-10
- activation of the tracks	P8, R4

Wheels

- assigning the functions	P8, R3
- activation of the tracks	P8, R4

Function Controllers

- use	P10 (S2R: R3)
- editing	R3

Audio Outputs

- programming	R4
---------------	----

GENERAL INDEX

1. INTRODUCTION	1
INTRODUCTION	2
About the S Series instruments	2
How to use this manual	3
Convention used in the manual	4
2. LAYOUTS	5
FRONT PANEL S2/S3	6
REAR PANEL S2/S3	9
FRONT PANEL S2R	10
REAR PANEL S2R	12
3. OVERVIEW OF THE INSTRUMENT & ITS EDIT/DATA HANDLING CAPACITY	13
OVERVIEW OF THE INSTRUMENT	14
The Music Processor concept	14
Sound synthesis	14
<i>Sampling</i>	14
<i>Waveforms</i>	15
<i>Filters and Sounds</i>	15
Bank/Song and Performance	16
<i>Performance</i>	16
Tracks	16
<i>The Track playing mode</i>	16
<i>Bank/Song</i>	16
<i>Track configuration</i>	17
<i>Multi-timbral</i>	17
<i>The mixer</i>	17
<i>"Mute" and "Solo"</i>	17
Sources and Destinations	18
<i>MIDI events</i>	18
<i>Sources</i>	18
<i>Destinations</i>	18
Internal memory and disks	19
<i>Overview of the data and the memorising facilities (floppy disk and Ram-disk)</i>	19
<i>The data</i>	19
MODES OF OPERATION: NORMAL, EDIT/HANDLING	20
<i>Normal operative mode</i>	20
<i>Edit/Data Handling mode</i>	20
<i>Multitasking</i>	20

OVERVIEW OF THE EDIT/HANDLING ENVIRONMENTS 21

- Edit, handling, utility environments 21
- The pages 21
- The menus 22
 - The structure and selection of the menus* 22
- Commands/options 22
- Parameters 22
 - Simple parameter* 22
 - Main menu and secondary menus* 22
 - Multiple parameter* 23
 - Graphic parameter* 23
- Escape from edit/handling 24
 - Analysis of the 'edit sound' edit environment* 24
- Analysis of two edit/handling environments 24
 - The "Are you sure?" display* 24
 - Analysis of the 'disk' handling environment* 25

4. INSTALLATION, POWER UP, DEMO 27

CONNECTING THE POWER CABLE 28

CONNECT THE AUDIO CABLES 28

- Connecting to an external amplification system* 28
- Stereo headphones* 28

S2R: CONNECTING TO A MASTER KEYBOARD OR TO AN EXTERNAL SEQUENCER 29

- Connecting to a Master keyboard 29
 - Connect the Midi ports* 29
 - Connecting to a monosplit master keyboard (via Midi-Common)* 29
 - Connecting to a multisplit master keyboard* 29
- Connecting to an external sequencer 30
 - Connecting the Midi ports* 30
 - Check the track status of the midi in Source* 30
 - Deactivation of Midi-Common* 30
- How to deactivate the Midi-Common channel 31
- Save the Midi-Common status to disk 31
 - How to save the Midi-Common status to floppy disk* 31
 - Save the Midi-Common status to the Ram-disk* 32

POWER UP 33

- Powering up with empty disk drive RAM-disk* 33
- Powering up with a floppy disk inserted in the drive* 33
- Powering up with data in the RAM-disk* 33
- Regulating the volume* 33
- Before turning off the instrument...* 33

S2R: "SOUND TEST" 34

- Sound Test in the main display* 34
- Sound Test in the Sample Translator* 34

DEMO 35

- The ROM demonstration Song 35
- The "Demo Disk 01" and "Demo Disk 02" demo songs 35
 - Load the contents of "Demo Disk 01" automatically* 35
 - Play back the "Demo Disk 01" demo songs* 35
 - Interrupt the "Demo Disk 01" demo songs* 35

Load the contents of “Demo Disk 02” in Ram 36
Playback the “Demo Disk 02” demo song 36
Cancel the “Demo Disk 02” demo song from the Music Processor’s memory 36

5. USER INTERFACE / SELECTION 37

DATA ENTRY COMMANDS 38
 Dial, +1/> and -1/<, Enter, Exit 38
 Alphanumeric keypad 38
 How to specify numeric data 38
 How to enter alphabetic characters 39
 Navigating with the Dial, Enter and Exit 39
 Use of the numeric keypad to navigate in the menus 40

«EMERGENCY» BUTTONS 41
 PANIC 41
 MIDI OFF (S2/S3) 41
 EFF. BYPASS 41
 UNDO 41

DISPLAY AND ASSOCIATED CONTROLS 42

MAIN DISPLAY / SAVE PERFORMANCE 43
 “Performance” mode 43
 “Sounds” mode 43
 “Save Performance” (save) 44
 “Save Performance” in S2/S3 44
 “Save Performance” in S2R 44

BANK/SONG AND PERFORMANCE SELECTION 45
 Selecting the Bank/Songs and Performances in S2/S3 45
 Selecting with the buttons of the Bank/Song and Performance sections 45
 Selecting the Bank/Songs and Performances in S2R 45
 Selecting in “Performance” mode 45
 Selecting Bank/Song and Performances in “Sounds” mode 45
 Selecting in “Performance” mode 45
 Selecting a Performance of the active Bank/Song in “Sounds” mode 45

SELECTING SOUNDS 46
 Selecting Sounds with the Dial (or the +1/> and -1/< buttons) 46
 Selecting Sounds with the alphanumeric keypad 46
 Selecting Sounds directly from the Sound Library 46

CORRECT TRACK VISUALISATION 47
 Visualisation of the tracks that can be played on a keyboard 47
 Visualisation of the tracks that can be played via Midi In (not Midi-Common) 47
 Visualisation of the tracks played by a Song 47

TRACK PLAYING MODE 48
 Track playing modes available for each Source 48
 Description of the track playing modes 48
 i How to set a split point for the split track playing mode 49

PLAY, MUTE, SOLO 50
 Play 50
 Mute 50
 Solo 50

6. PRACTICAL GUIDE 51

1 PREPARE A WORK DISK WITH THE S SERIES DISK DRIVE	52
2 LOAD THE CONTENTS OF A DISK INTO MEMORY	53
<i>Load all the instrument's data from disk</i>	53
<i>Load a Group of Bank/Songs</i>	54
<i>Load a Single Bank/Song</i>	54
<i>Load a Setup</i>	55
3 SAVE THE CONTENTS OF MEMORY TO DISK	57
<i>Save all the instrument's data to disk</i>	57
<i>Save all the Bank/Songs in a Group</i>	58
<i>Save a single Bank/Song</i>	58
<i>Save a single Setup</i>	59
4 LOAD AND SAVE A MIDI-FILE	61
<i>Memory format and Midi-files</i>	61
<i>Compatibility of the sounds (Midi-files in General Midi/GS standard)</i>	61
<i>Activation of the General Midi/GS compatibility</i>	61
Load a Midi-file	62
Save a Midi-file	63
5 OVERVIEW OF THE DISKS SUPPLIED WITH THE INSTRUMENT	65
"Demo Disk 01"	65
<i>The Bank/Song directory</i>	65
<i>The Setup directory</i>	66
<i>Check the Ram-Sounds contained in Demo Disk 01</i>	67
<i>Load the Bank/Songs and Setups from Demo Disk 01</i>	67
"Demo Disk 02"	68
<i>Load the new pianoforte from Demo Disk 02</i>	68
"Freeware Disk"	69
<i>The "Hardcopy" program</i>	69
<i>The "Disk_Dir" program</i>	69
<i>The "Copy_Prg" program</i>	69
6 SONG PLAYBACK / THE SEQUENCER CONTROLS	70
<i>Load a Song using the standard procedure</i>	70
<i>Use Preload to load a Song in background</i>	70
<i>How to select the Song</i>	70
<i>The Sequencer</i>	71
7 CREATE OR MODIFY THE BANK/SONGS	72
Cancel Song 1 (Demo)	72
Prepare a start-up disk to power up without Song 1 (Demo)	72
Record a new Song using the Performances of an existing Bank/Song	73
<i>Using a Bank/Song already present in memory</i>	73
<i>Using a Bank/Song contained in a disk</i>	73
Create a new Bank/Song	74
<i>Cancel one of the 10 default Bank/Songs present in memory</i>	74
<i>Create a completely new Bank/Song</i>	74
8 EDITING THE PERFORMANCES	75
Create, copy and cancel the tracks	75
<i>How to cancel tracks</i>	75
<i>How to create tracks</i>	75
<i>Copy a track to another</i>	76

How to assign the Sounds to the tracks	76
<i>Select the Sounds from the main display</i>	76
<i>Select the Sounds from the Sound Library</i>	76
Set the tracks to Play or Mute	77
Track volumes	77
<i>How to vary the track Volumes with the Function Controllers</i>	77
<i>How to vary the Volumes in edit performance/tracks</i>	78
TRANSCOPE	78
<i>How to vary the track transposition in the track transposer</i>	78
<i>How to vary the track transposition in edit performance/tracks</i>	79
Effects	79
<i>How to assign the Effects to a Performance</i>	79
<i>How to engage the Effects to the tracks</i>	80
How to activate and programme the pedals and wheels	80
<i>How to assign a function to a pedal and wheel</i>	80
<i>How to activate/deactivate the pedals and wheels for the tracks</i>	81
Save the modifications to the Performance	81
9 HOW TO RECORD A SONG	82
<i>What is a Song?</i>	82
<i>The Song tracks</i>	82
<i>Prepare the tracks for the recording</i>	82
<i>Activate Record mode and select the recording options</i>	83
<i>Select the parameters of the Song</i>	84
<i>The Song pointer (locator)</i>	84
<i>Now record the Song</i>	85
<i>Recording methods</i>	85
10 REAL TIME SOUND EDITING	86
The S2/S3 hardware Function Controllers	86
<i>Panel mode</i>	87
<i>User mode</i>	88
The S2R Function Controller	88
Save the modifications to the Performance	89
11 EDITING SOUNDS IN THE STUDIO	90
Types of Sound	90
<i>The three fundamental Sound types</i>	90
<i>The combinations: Sound Patch and Drumkits</i>	90
<i>Rom-Sound, Ram-Sound, Ram ↕ Sound</i>	91
Waveform	91
Filters	91
<i>The filters and the Cutoff-frequency</i>	91
<i>Resonance</i>	91
<i>The filter envelopes</i>	92
Envelopes	92
<i>Types of Envelopes</i>	92
<i>Programming the envelopes</i>	92
Tracking	93
<i>Types of Tracking</i>	93
<i>Programming the Tracking</i>	93
Lfo, Pitch, Pan	94
<i>Lfo</i>	94
<i>Pitch</i>	94
<i>Pan</i>	94
Memorising the Sound in the Sound Library	95

<i>Escape from edit sound</i>	95
<i>Escape edit sound and cancel the modifications</i>	95
<i>Escape from edit sound saving the Sound in the Sound Library</i>	95
<i>Save the Sound Library to disk</i>	95
12 SELECTING THE SOUNDS VIA MIDI	96
Selecting the Sounds with Bank Select and Program Change	96
<i>The Program Change</i>	96
<i>The Bank Select (Midi Controller 0)</i>	96
Select the Sounds via the Performance Change event	98
<i>Programming the Midi-Common channel</i>	98
<i>Select the Performances via Midi-Common</i>	98
13 SELECTING THE EFFECTS VIA MIDI	100
<i>Programming the Midi-Common channel</i>	100
<i>Controlling the Effects via Midi-Common</i>	100
14 EDITING SOUNDS VIA MIDI	101
15 PROGRAMMING WITH AN EXTERNAL SEQUENCER — PERFORMANCE 10 OF BANK/SONG 1 ...	102

7. SAMPLE TRANSLATOR	105
-----------------------------------	------------

SAMPLE TRANSLATOR 2.0	106
<i>About Sample Translator</i>	106
<i>Waveforms and multi-samples</i>	106
<i>Accessing Sample Translator</i>	107
<i>Temporary escape from Sample Translator</i>	107
The “Waveform” display	108
<i>The “Waveform” command functions</i>	108
Loading samples (“Load”)	109
1. <i>Loading a sample contained in a Ram-Sound</i>	109
2. <i>Loading a sample via MIDI</i>	109
3. <i>Loading samples from Ms-Dos/Atari floppy disks</i>	111
4. <i>Loading Samples and Programs from an Akai S1000 floppy disk</i>	112
<i>“Cut End”</i>	114
Assigning samples to a keyboard range (“Assign”)	114
<i>Cancelling assignments (“UnAssign”)</i>	115
<i>Re-assigning limits after an Unassign command</i>	115
“Play Single” display	116
<i>“Zoom”</i>	116
<i>“Gain”</i>	117
<i>“Loop nr:(x)”</i>	117
<i>“Send”</i>	117
<i>“Exit”</i>	118
The “Info about” display	118
<i>“Note”</i>	118
<i>“SR”</i>	119
<i>“Length” (cannot be modified)</i>	119
<i>“Loop Start” & “Loop End”</i>	119
<i>“Loop Type”</i>	120
<i>“Note range” (cannot be modified)</i>	120
<i>Commands in the right-hand column</i>	121
Cancelling a sample (“Delete”)	121
Copying a sample to a different location (“Copy & Paste”)	121
Saving a Waveform (“Save”)	122
Escape from Sample Translator	123

8. REFERENCE GUIDE 125

1	THE SOURCE SECTION	126
	<i>The buttons in the Source section</i>	126
	<i>Local Source</i>	126
	<i>i The Set split command</i>	127
	<i>Midi in Source</i>	127
	<i>Song Source</i>	128
	<i>Option Source</i>	128
	<i>The solo button</i>	128
2	TRACK TRANSPOSER / MASTER TRANSPOSER	129
	<i>The track transposer button</i>	129
	<i>Track Transposer</i>	129
	<i>Master Transposer</i>	129
	<i>The master transpose buttons (only S2/S3)</i>	129
3	EDIT PERFORMANCE/CONTROLS	131
	<i>Page 1 Effects</i>	131
	<i>Page 2 Controllers (S2/S3)</i>	131
	<i>Page 3: User Keys (S2/S3)</i>	132
	<i>Page 4: User Controllers (S2/S3)</i>	132
	<i>Page 2: Controllers (S2R)</i>	132
	<i>Page 3: Function Controller (S2R)</i>	132
	Assignable MIDI messages	133
4	EDIT PERFORMANCE/TRACKS	134
	<i>General commands</i>	134
	<i>Page 1: Configuration</i>	135
	<i>Page 2: Common</i>	136
	<i>Page 3: Local (S2/S3)</i>	137
	<i>Page 3: Local (S2R)</i>	138
	<i>Page 4: Internal Sound</i>	139
	<i>Page 5: Midi Filter In</i>	139
	<i>Page 6: Midi Filter Out</i>	140
	MIDI messages assignable to the Midi Filters (In & Out)	140
	<i>Notes and suggestions</i>	141
5	EDIT SOUND	142
	<i>Single Oscillator (SO), Dual Oscillator (DO), Dual Crossfade (DC) Sounds</i>	142
	<i>Sound types</i>	142
	<i>Polyphony obtained with different types of sounds</i>	143
	<i>Maximum polyphony obtainable in the various track playing modes</i>	143
	<i>Access the edit sound environment</i>	143
	<i>The edit environment (the editors of the edit sound menu)</i>	143
	<i>The editors of the edit sound menu</i>	143
	<i>The options of the main menu and of the editors</i>	144
	<i>The options of the main menu</i>	144
	<i>The editor options (secondary menus)</i>	144
	<i>Status of the instrument in edit sound mode</i>	144
	<i>Temporary escape from edit sound</i>	144
	<i>Escaping from edit sound and saving the modified sound</i>	144
	<i>Possible error messages during the Sound save task</i>	145
	<i>Escape from edit sound without memorising the modified sound</i>	145
	Converting a Sound to a different type	146
	<i>Conversion limits</i>	146
	Waveset	147
	<i>Waveform (Sound Dual Crossfade)</i>	147
	<i>Waveform (Single Oscillator Sound)</i>	147

Page 1 Waveform (Dual Oscillator Sound).....	148
Page 2 Oscillator Balance (Dual Oscillator Sound)	148
Volume	149
Page 1 Volume	149
Page 2 Volume Tracking	149
Amplitude envelope	150
Page 1 Amplitude Envelope Control	150
Page 2 Amplitude Key On	151
Page 3 Amplitude Key Off.....	152
Page 4 Amplitude Envelope Tracking	152
Lfo	153
Lfo	153
Filter 1/2	154
Page 1 Filter 1	155
Page 2 Filter 2	155
Page 3 Filter 1 Tracking	156
Page 4: Filter 2 Tracking	156
Filter Envelope (dc and do sounds)	157
Page 1 Filter Envelope Control	157
Page 2: Filter Key On Envelope	157
Page 3 Filter Key Off Envelope	158
Page 4 Filter Envelope Tracking	159
Pitch Envelope	160
Page 1 Pitch Envelope Control	160
Page 2 Pitch Key On Envelope	160
Page 3: Pitch Key Off Envelope.....	161
Page 4 Filter Envelope Tracking	162
Pan	163
Page 1 Pan Envelope Control (DC and DO Sounds)	163
Page 2 Pan Key On Envelope (DC and DO Sounds).....	163
Page 3 Pan Key Off Envelope (Sound DC and DO).....	164
Page 4 Pan Tracking (DC and DO Sounds)	165
Pan Control (Sound SO)	165
ROM-Waveforms with separate Pitch Envelopes for the two oscillators even when Detune=0	166
Notes and suggestions	167
6 SAMPLE TRANSLATOR	169
Accessing Sample Translator	169
The instrument status during the Sample Translator tasks	170
Controlling the S2R.....	170
Temporary escape from Sample Translator	170
A closer look at Sample Translator	170
The Waveform display	171
Load.....	171
Save	172
Assign	172
UnAssign	172
Play Single	173
Info About.....	173
Exit	174
Cut End.....	175
Delete	175
Copy	175
Paste	175
7 SOUND PATCH AND DRUMKIT	176
The Sound Patch edit environment.....	176
Commands/options	176
Parameters	177

Notes and suggestions	178
8 SEQUENCER AND SONG	179
<i>What is a Sequencer – The S Series Sequencer</i>	179
<i>Playback and Record</i>	179
<i>The Song and the Performance Bank</i>	179
<i>The sequencer controls</i>	180
<i>Creating a Song</i>	180
<i>Creating a Bank/Song</i>	180
<i>Creating a Performance with default values</i>	180
<i>Cancelling the Song</i>	181
<i>Recording a new Song</i>	181
<i>“Undo”</i>	182
Notes and suggestions	182
9 EDIT SONG MODE	184
<i>Accessing edit song mode</i>	184
<i>The main menu editors of edit song</i>	184
<i>Options of the main menu of edit song</i>	184
<i>Options of the secondary menus</i>	184
<i>Selecting the Tracks in Edit</i>	185
<i>Selection Screen</i>	185
<i>“Execute”</i>	185
<i>“Undo”</i>	185
Erase events	186
<i>Page 1: Erase from track</i>	186
<i>Page 2: Erase from Master Track</i>	186
Move events	187
<i>Move from track</i>	187
Insert/delete bars	188
<i>Page 1: Insert bars</i>	188
<i>Page 2: Delete bars</i>	188
Dynamic	189
<i>Dynamic</i>	189
Transpose	189
<i>Transpose</i>	189
Quantize	190
<i>Page 1: Quantize Key On</i>	190
<i>Page 2: Quantize Key Off</i>	191
Copy	191
<i>Page 1: Copy from single track</i>	192
<i>Page 2: Copy all tracks</i>	192
<i>Page 3: Append</i>	192
Microscope	193
<i>Accessing the events of the Event List and their parameters</i>	193
<i>Moving to a data bar</i>	193
<i>Selecting an event with Catch Locator</i>	194
<i>Programmable Events and Parameters</i>	194
<i>The Command/Options Column</i>	195
<i>Commands/options</i>	195
<i>“Undo”</i>	196
Utility	196
<i>Utility</i>	196
Master Track	197
<i>Accessing the events on the Event List and their values</i>	197
<i>Moving to a data bar</i>	197
<i>Selecting an event with Catch Locator</i>	198
<i>Programmable Events and Parameters</i>	198
<i>The Command/Options Column</i>	198

<i>Commands/options</i>	198
“Undo”	199
Notes and suggestions	200
10 EDIT GENERAL	201
Tuning/Scale	201
<i>Page 1: Tuning/Scale</i>	201
<i>Page 2: Edit Keyboard Scale</i>	202
Footswitch controls	203
MIDI	203
<i>Page 1: Midi (1)</i>	204
<i>Page 2: Midi (2)</i>	205
Date/Time set	205
<i>Date & Time</i>	205
Dynamic/touch sensitivity (s2/s3)	205
<i>Sensitivity</i>	205
Sound test (s2r)	206
<i>Sound test</i>	206
General Midi	206
<i>General Midi</i>	207
Notes and suggestions	208
11 DISK	209
<i>Automatic loading when powering up</i>	209
<i>The Ram-disk</i>	210
<i>The Groups</i>	210
Organisation of the disk environment	211
<i>General commands/options</i>	211
<i>i Directory</i>	212
<i>i Data displayed in the directories</i>	213
The Disk environment pages (Load, Save, Erase, Utility)	214
<i>Load</i>	214
<i>Save</i>	215
<i>Erase</i>	216
<i>Utility</i>	216
Possible error messages during disk operations	219
<i>Errors common to all operations</i>	219
<i>Load errors</i>	219
<i>Load and Erase Errors</i>	219
<i>Formats of the magnetic supports used</i>	220
Notes and suggestions	220
12 SOUND LIBRARY	221
<i>How the Sound Library is organised</i>	221
<i>The Sound Library display</i>	221
<i>Selecting Families and Sounds</i>	221
<i>Selecting Sounds by entering the Program Change and Bank Select number</i>	222
<i>Selecting Sounds with the search function</i>	222
<i>Commands/options</i>	222
<i>Types of Sounds and their identification symbols</i>	224
13 EFFECTS LIBRARIES	225
<i>How the Effects Libraries are organised</i>	225
<i>Selecting the Effects</i>	225
<i>Command/options</i>	226
Library 1 (standard)	226
Library 2 (standard)	226

14 EDIT EFFECT	227
<i>How to access the effect edit</i>	227
<i>How to escape from the effect edit</i>	227
<i>How the edit effect environment is organised</i>	227
How to Programme the Effects of Library 1	228
<i>Reverbs without programmable early-reflections</i>	228
<i>Reverbs with programmable early-reflections</i>	228
How to Programme the Effects of Library 2	229
<i>Delay, Panecho, Dubbing</i>	229
<i>Chorus</i>	229
<i>Flanger</i>	230
<i>Phaser, Ensemble</i>	230
<i>Rotary</i>	231
<i>Fladel, Panmix</i>	231
<i>Notes and suggestions</i>	232
15 CLIPBOARD	234
<i>Layout of the "Clipboard" page</i>	234
<i>How to copy an edit page</i>	234
<i>How to copy a clip to an edit page</i>	234
<i>How to cancel a clip from the Clipboard</i>	234
16 UTILITY	235
<i>"Juke_box"</i>	235
<i>Utility</i>	235
17 PRELOAD	237

APPENDIX..... i

MIDI IMPLEMENTATION CHART	IV
MESSAGGI MIDI / MIDI CONTROLLERS	V
MIDI SYSTEM EXCLUSIVE CODE INTERFACE	VI
LIST OF THE WAVEFORMS RESIDENT IN ROM (ROM-WAVEFORMS)	XIV
THE ROM SOUND MAP	XV
TABLE OF THE PERFORMANCES CONTAINED IN ROM	XXII
THE DRUMKITS OF THE STANDARD SOUND LIBRARY	XXVI
PERCUSSION SAMPLES	XXXVI
TECHNICAL SPECIFICATIONS	XXXVIII

GLOSSARY / ALPHABETICAL INDEX a
--

GLOSSARY	B
MIDI MESSAGES/MIDI CONTROLLERS	E
TROUBLESHOOTING	I

INTRODUCTION

□ INTRODUCTION

INTRODUCTION

Congratulations and thanks for purchasing the S Series Music Processor - an instrument conceived and developed with the most up-to-date technology to guarantee a high degree of reliability and durability.

The name "Music Processor" describes the instrument's ability to handle the complete creative process, starting from sound synthesis right down to the registration of multi-timbric songs and the complete control of the entire MIDI setup.

We are confident that you will find your S Series Music Processor beyond all expectations.

About the S Series instruments

S2 Turbo and **S3 Turbo Music Processors** are keyboard synthesizers with 61 keys and 76 keys respectively. This manual also refers to the previous models upgraded with the "Turbokit" board. S2 and S3 also operate as Master Keyboards, thanks to the integrated controls (Wheels, Function Controllers) and extensive MIDI programmability.

S2R is the 19" rack version of the S2/S3 Turbo. It is totally compatible with these two keyboard synthesizers.

- **Multitimbral generator**

The S Series instruments are 16 part multi-timbral units with a maximum polyphony of 32 notes.

- **Sound generation method**

Sound generation is based on a mixed digital/analog technology which permits, through the use of analog techniques, the manipulation of Samples of real or synthetic origin. The S Series Sounds are based on sampled Waveforms which are processed by one or two digital State Variable Filters with programmable envelope. Separately, each filter provide a 12 dB per octave slope (2 pole). Combined, they operate as a 4 pole filter with a 24 dB per octave slope.

- **ROM and RAM Sounds**

The permanent memory (ROM) houses 6 Megabytes of Waveform, the basic element which provides more than 500 Rom Sounds.

2 Megabytes of Sample RAM are ready to receive (from disk or MIDI) other Waveforms, for the creation of Sounds based on new Waveforms created with the Sample Translator.

The new Waveforms can be loaded from Atari/MS-DOS floppy disks in the formats Sound Designer, Avalon, Sample Vision, Wave. They can be loaded from Akai S1000 disks, or received via MIDI.

The Sound Library is where the Sounds are housed. It can contain up to 2048 Sounds (ROM + RAM Sounds).

- **Amount of RAM**

The S Series units are fitted with 4 Megabytes of RAM (volatile):

- 2 Megabytes of Operative-Ram to process and control the Banks and the Songs;

- 2 Megabytes of Sample-Ram to control the Waveforms created with Sample Translator or loaded with the RAM-Sounds.

- **2 Digital Signal Processors**

Two Digital Effects Processors, controlled in real time, enrich the sound with environ-

mental and creative effects (reverbs and modulations). The Effects Libraries house the Effects and they can store up to 64 reverbs and 64 modulations.

- **Sequencer**

The multi-track sequencer can memorise 250.000 events in the 2 Megabyte Operative-RAM. This 16 track sequencer has a very extensive Event Edit facility, including the functions Master Track, Copy, Insert/Delete Events, Quantize, Microscope and others.

- **Disk drive**

The S Series Music Processor data can be saved to floppy disk via the disk drive, which handles 3.5" HD floppy disks and force-formats them with a capacity of 1.62 Megabytes. The drive can also format and use Ms-Dos floppy disks (1.44 Mb or 720 Kb) or Atari (720 Kb), for the transferring of MIDI Files and Samples read by Sample Translator.

- **RAM-disk**

The S Series Music Processor can be fitted with a 512 kb or 2 Mb optional Static RAM (NON-VOLATILE), backed by a small rechargeable Nickel/Cadmium battery. The RAM-disk is a fixed disk with high speed accessing facilities.

- **Mios multitasking operating system**

The S Series Music Instrument Operating System allows simultaneous operation of several tasks, such as modifying a Sound, playing back a Song, loading a Song in background, etc..

- **User Program**

The MIOS can be expanded by User Programs, made available from time to time by Generalmusic, providing the instrument with additional functions by loading appropriate software via floppy disk.

- **Advanced MIDI control**

The S Series Music Processors incorporate 2 independent MIDI lines with MIDI-Merge and MIDI-Thru functions. These instruments are fully implemented MIDI units.

- **SampleTranslator 2.0 incorporated**

SampleTranslator is a Waveform creating programme which allows the creation of new Sounds starting from samples originating from Akai S1000 floppies, from floppies containing files generated by the more popular computer editors, or from data received via MIDI.

- **Samples and Programs read from Akai S1000™ floppy disks**

The possibility of reading the Akai format allows the S Series instruments to gain access to the greatest sample library available on the market. The Programs (multisamples) are converted into Music Processor Waveforms.

How to use this manual

This manual is divided into several sections.

- *Overview of the instrument and the edit/handling environments* describes the sound synthesis technique and how the data handling operations are organised.
- *Installation, power up, demo* explains how to setup and turn on the instrument and how to listen to the demonstration songs (demo).
- *User interface/selection* explains how to use the Data Entry controls, examines the display and takes a look at the operations common to sound and data selection.
- *Practical guide* is a simplified guide for the non-expert synth user. The information contained in this section is sufficient for a normal use of the instrument: how to load songs and new Sounds from disk, how to record and play back a song, how to control

the instrument via MIDI.

- ❑ *Sample Translator* is the practical guide to the Sample Translator 2.0.
- ❑ *Reference guide* lists all the edit environment parameters and describes the instrument and all its functions in detail.
- ❑ *Appendix* contains schematic information (standard Sound Library, MIDI tables, technical specifications...).
- ❑ *Glossary/Index* contains the Glossary and an Alphabetical Index. The Glossary provides a list of the most commonly used technical terms. The alphabetical index lists all arguments dealt with in alphabetical order, indicating the relative page number and its relation to other arguments. This section also contains a Troubleshooting table to help you solve problems of a technical nature which may occur from time to time.

Convention used in the manual

The appearance of the symbols “S2/S3” or “S2R” indicate that the paragraph which follows is dedicated only to S2/S3 or S2R respectively.

The symbol (s.) indicates the presence of a detailed explanation of the argument in another part of the manual or glossary.

The symbols “Rom-” or “Ram-” cited before “Sound” or “Waveform” indicate, respectively, that the elements are contained in the instrument’s Rom (and, therefore, are a standard part of the instrument’s library), or in Ram (and, therefore, erasable and exchangeable).

LAYOUTS

□ LAYOUTS

- S2/S3 Front panel
 - S2/S3 Rear panel
 - S2R Front panel
 - S2R Rear panel
-

FRONT PANEL S2/S3

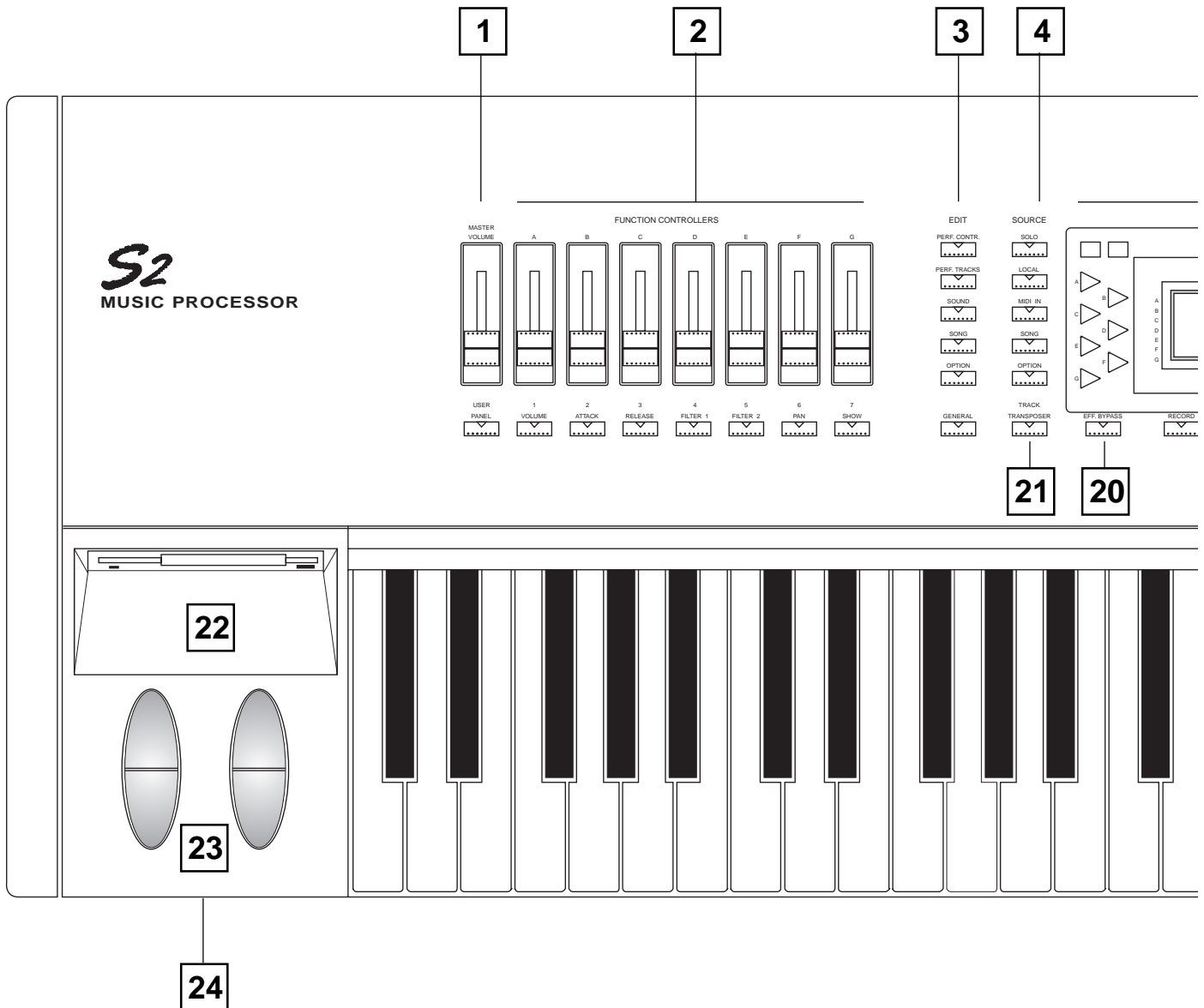

1. VOLUME. Slider to regulate the general volume.

2. FUNCTION CONTROLLERS. Sliders and keys that control the sound parameters. The Function Controllers marked A, B, C, D, E, F, G, correspond to the silk-screened letters on the left of the display; each letter relates to one of the tracks that appear in the display.

3. EDIT SECTION. These buttons gain access to the edit environments:

- **PERF.CONTR** allows the programming of the general Performance parameters (effects, footswitch) and the Function Controllers.
- **PERF.TRACKS** gains access to the programming tasks of the Performance tracks (MIDI channels, configuration, volume, transpose, delay, aftertouch, footswitch activation, audio outputs, MIDI filters).

– **SOUND** allows the modification of the Sound assigned to the currently selected Track and gains access to the Sample Translator.

– **SONG** controls the sequencer. Pressing this button gains access to the “Playback” display, which shows the Song Pointer in playback mode. From here you can gain access to the Edit of the currently selected song.

– **OPTION** is available for future expansion programs loaded from disk (User Programs).

– **GENERAL** controls all the general keyboard parameters: keyboard transpose and tuning, footswitch polarity, MIDI parameters, Data/Time, compatibility General Midi On/Off switch.

4. SOURCE SECTION. Allows the independent check and edit of the Track configurations relating to each Source. The Sources

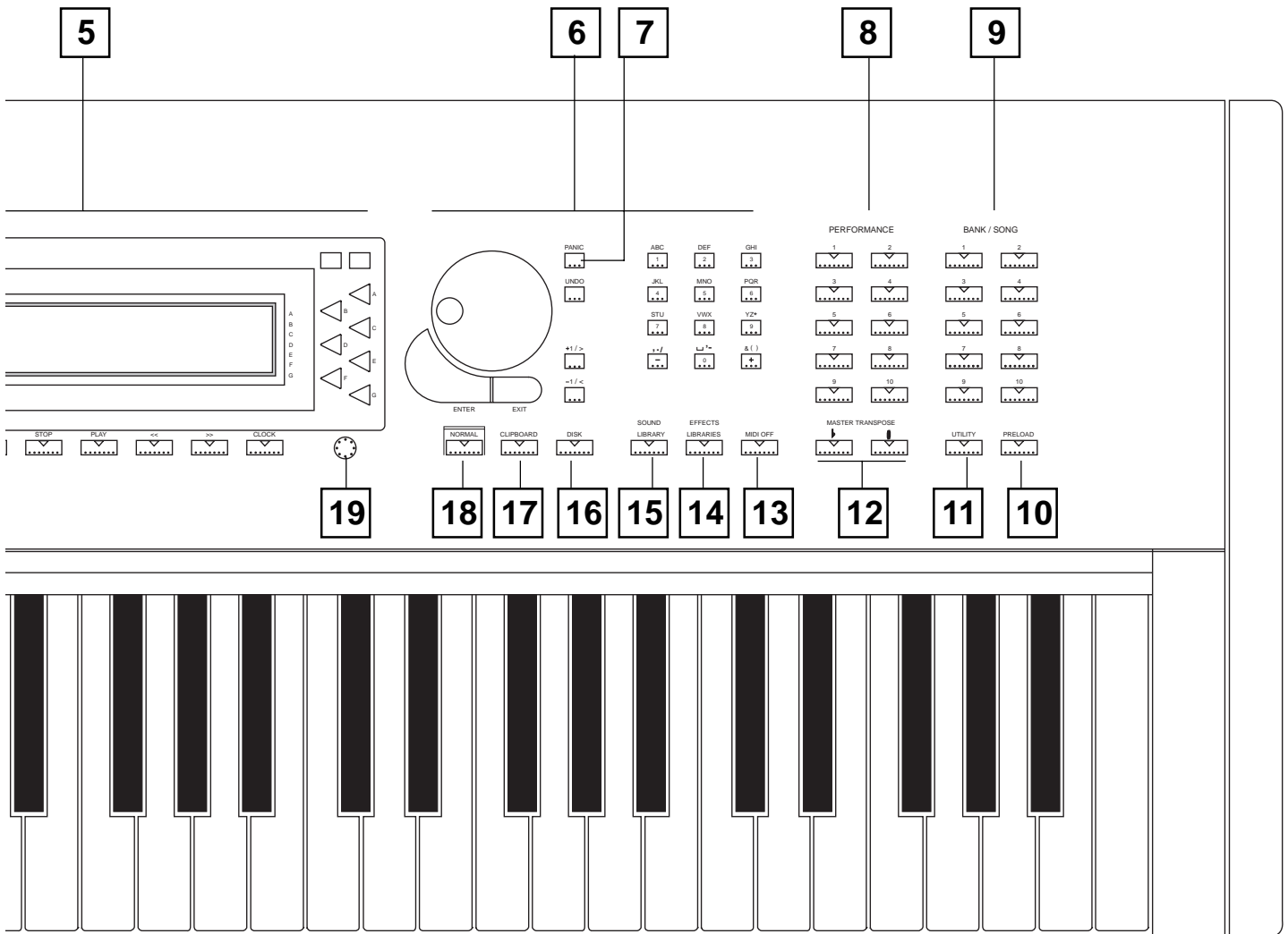

are the origins of MIDI DATA which control the sound generation: keyboard (LOCAL), events received at Midi In (MIDI IN), internal sequencer (SONG), future expansions (OPTION).

5. DISPLAY AND ASSOCIATED CONTROLS. The backlit LCD display has dimensions of 240 x 64 pixel. The triangular buttons on the left select the tracks (TRACK SELECT KEYS), the buttons on the right operate according to the commands and options which appear in the display (FUNCTION KEYS).

The two small rectangular buttons on the left allow you to bring into view, on seven lines, 16 tracks of the current Performance (TRACK SCROLL BUTTONS). The two small rectangular buttons on the right operate according to the commands which appear in the display (MULTIFUNCTION BUTTONS).

When the main display is showing (the one that appears after powering up) the FUNCTION KEYS select the viewing mode

(Performance or Sounds). In Sounds mode (as shown in the illustration), these buttons select the track playing mode (Single, Multi...). The RIGHT MULTIFUNCTION BUTTON gains access to the Save Performance command.

6. DATA ENTRY SECTION. This section is divided into two distinct parts:

- the DIAL can be rotated freely in both directions to change the current data value continuously, to change Performance or Sound, to move the reverse-highlighted cursor within the edit page menus. The +1/> and -1/< buttons operate in exactly the same manner as the Dial, but increases or decreases data in single units.

ENTER confirms data entered or commands; in edit environments, it gains access to parameters that require modifications. EXIT annuls values inserted or cancels some commands.

– the **ALPHANUMERIC KEYPAD** is used to specify absolute numeric data or alphabetic data. For numeric data entry, confirmation with **ENTER** is always required. It is also used to gain direct access to the menu parameters in edit environments (without the use of **ENTER**).

The Data Entry section also makes use of the **UNDO** function. **UNDO** undoes or reverses the most recent action or restores the last saved situation. There is also an **UNDO** specific to the sequencer.

7. PANIC. Emergency button which sends an “All Note Off”, a “Reset Controls” and an “unlock” message to notes and controls “locked” by, for example, the reception of a “bad” MIDI event.

8. PERFORMANCE. Performance select buttons.

9. BANK/SONG. Bank/Song select buttons.

10. PRELOAD. Allows background song loading (while the sequencer is in playback).

11. UTILITY. Gains access to several useful applications: change Performance or Bank/Song name, cancel Bank/Song and Performance, copy Bank/Song and Performance.

12. MASTER TRANSPOSE. General transposer, in semitone steps.

13. MIDI OFF. Allows the temporary disconnection of the MIDI ports (when the led is on).

14. EFFECTS LIBRARIES. Storage facilities for the Effects, one for the Reverberations and another for the Modulations.

15. SOUND LIBRARY. An archive which stores all the Sounds in the instrument’s memory. Incorporated are functions which permit the importation of single Sounds from floppy disks containing other Sound Libraries (imp_disk and imp_ramd).

16. DISK. Gains access to all the data handling procedures on floppy disk and Ram-disk. The operations are Load, Save, Erase and a Utility menu with several functions (Format, Disk Name, MIDI-file conversion).

17. CLIPBOARD. An application which allows “clips” of edit situations to be stored and used in other edit environments to save time.

18. NORMAL. Returns to the main display from any situation.

19. CONTRAST. Controls the brightness of the display and requires adjustment for different viewing angles.

20. EFF. BYPASS. A temporary deactivating device for the Effects (led on) - the sounds are emitted “dry” from the Stereo Left & Right Outputs. Normally (led off), the sounds are emitted “wet” from this output pair.

21. TRACK TRANSPOSER. Individual and independent Track Transposer. Also provides the “Master” command which gains access to the general transposition of the instrument.

22. DISK DRIVE. Reads and formats 3.5” HD floppy disks (force-format to 1.62 Mb) for the saving and loading of S Series data. Also formats, reads and writes on 3.5” DD floppies (Ms-Dos or Atari) for MIDI-file data exchange. Recognises and loads samples from Akai S/1000 format disks.

23. WHEELS. Two wheels completely and independently programmable. The left Wheel is predisposed for Pitch Bend and is spring loaded to return to the centre position. The right wheel, normally assigned to provide Modulation, is centre-dented so that you can take it exactly to centre position. Its normal position is with the centre-dented mark at its lowest point to avoid hearing Sounds with Modulation.

24. PHONES. Stereo headphones socket.

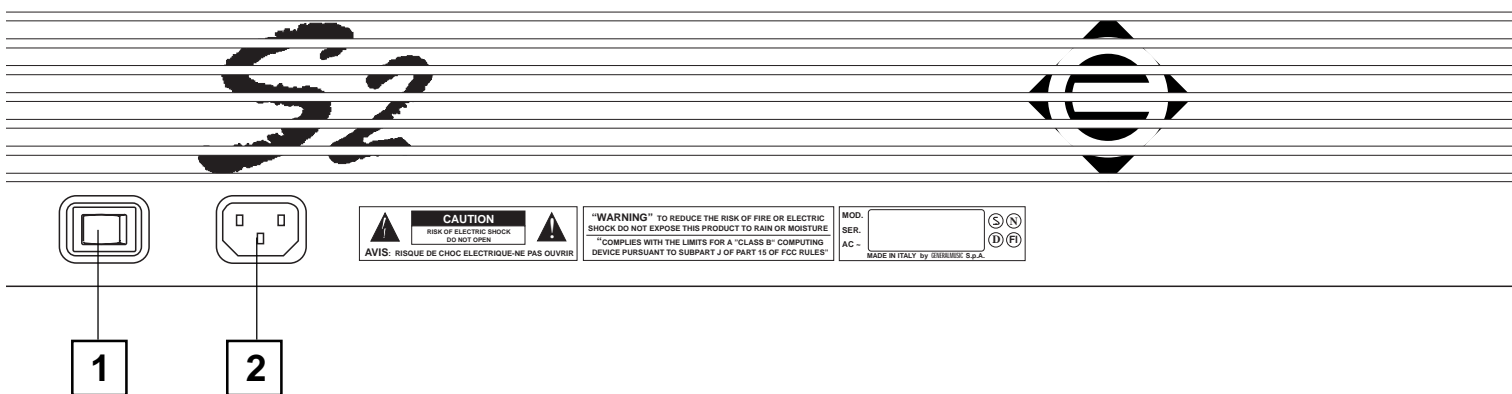

REAR PANEL S2/S3

1. POWER SWITCH. Small rocker switch with On/Off positions.

2. MAINS SOCKET. Connect the supplied power cable to this socket. Connect the other end to an AC outlet of the correct voltage.

Warning: check for the correct voltage before connecting your instrument. The correct voltage is silk-screened close to the mains socket.

2. OUTPUTS. Audio outputs which can operate as six separate mono outputs or as three stereo pairs.

LEFT/RIGHT: “wet” signal emitters. The instrument checks the insertion of the jacks; if only one output is connected, the complete mono signal is emitted from the relative socket.

1, 2, 3, 4: “dry” signal emitters.

3. PEDAL VOLUME. Connection for a *continuous control* pedal to control the general Volume.

4. PEDAL/FOOTSWITCH 1 & 2. Connections for continuous control Pedals (to control parameters such as Volume, Expression, etc.), or Footswitch pedals (switch control pedals) to control parameters such as Damper, Start/Stop, Performance advance, etc.. The programming facilities of the pedals are found in EDIT PERFORMANCE/CONTROLS, EDIT PERFORMANCE/TRACKS, EDIT GENERAL.

5. MIDI PORTS. A double series of MIDI ports: MIDI IN 1&2, MIDI OUT 1&2 and MIDI THRU 1&2. Set “1” are active by default. The MIDI ports allow S2/S3 to be controlled by external MIDI controlling units and allow slaved devices to be controlled by S2/S3.

IN 1 – IN 2: connections for any MIDI controlling device (master keyboard, sequencer, guitar controller, Midi Accordion ...).

OUT 1 – OUT 2: connections for instruments slaved to the S2/S3 which can be controlled by S2/S3’s internal sequencer. If MIDI-MERGE is active, these ports also transmit the MIDI data received at MIDI IN.

THRU 1 – THRU 2: the data received at MIDI IN escape from these ports.

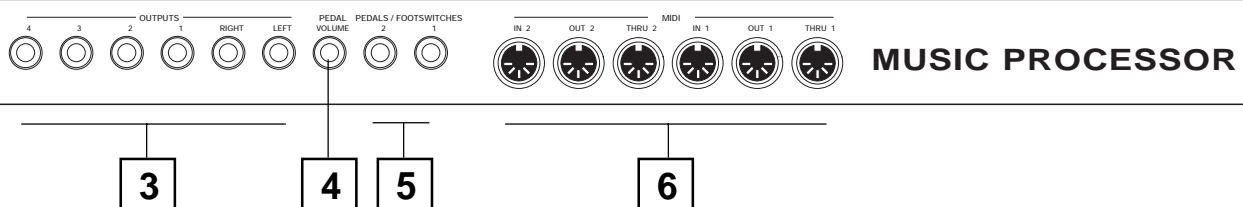

FRONT PANEL S2R

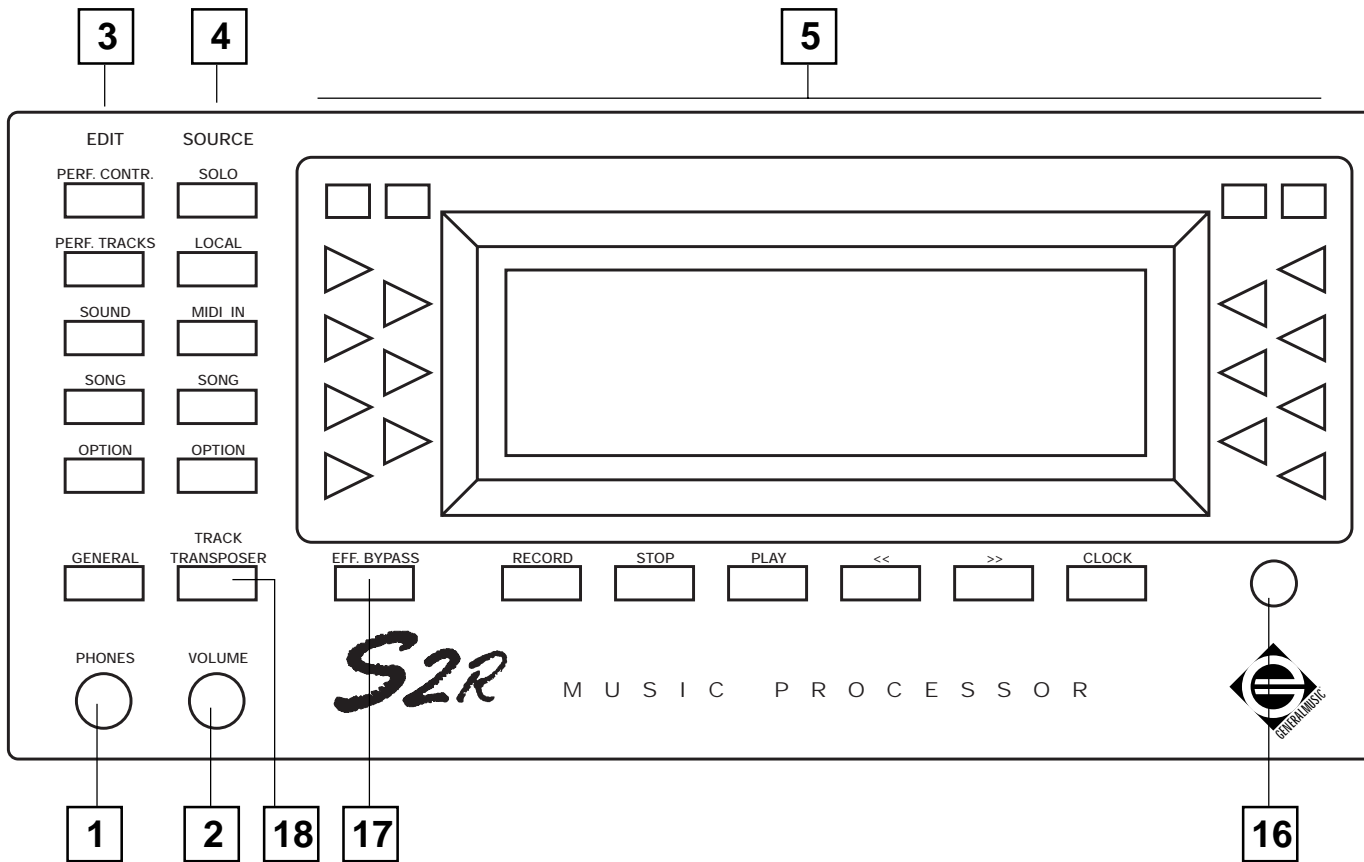

1. PHONES. Stereo headphones socket.

2. VOLUME. Slider to regulate the general volume of S2R.

3. EDIT SECTION. These buttons gain access to the S2R edit environments:

- **PERF. CONTR.** allows the programming of the general Performance parameters (effects, footswitch) and contains the Function Controller “software”.
- **PERF. TRACKS** gains access to the programming tasks of the Performance tracks (MIDI channels, configuration, volume, transpose, delay, aftertouch, footswitch activation, audio outputs, MIDI filters).
- **SOUND** allows the modification of the Sound assigned to the currently selected Track and gains access to the Sample Translator.
- **SONG** controls the sequencer. Pressing this button gains access to the “Playback” display, which shows the Song Pointer in playback mode. From here you can gain access to the Edit of the currently selected song.
- **OPTION** is available for future expansion programs loaded from disk (User Programs).

– **GENERAL** controls all the general parameters: S2R transpose and tuning, footswitch polarity, MIDI parameters, Data/Time, Sound Test, compatibility General Midi On/Off switch.

4. SOURCE SECTION. Allows the independent check and edit of the Track configurations relating to each Source. The Sources are the origins of MIDI DATA which control the sound generation: keyboard (**LOCAL**), events received at Midi In (**MIDI IN**), internal sequencer (**SONG**), future expansions (**OPTION**).

5. DISPLAY AND ASSOCIATED CONTROLS. The backlit LCD display has dimensions of 240 x 64 pixel. The triangular buttons on the left select the tracks (**TRACK SELECT KEYS**), the buttons on the right operate according to the commands and options which appear in the display (**FUNCTION KEYS**).

The two small rectangular buttons on the left allow you to bring into view, on seven lines, 16 tracks of the current Performance (**TRACK SCROLL BUTTONS**). The two small rectangular buttons on the right operate according to the commands which appear in the display (**MULTIFUNCTION BUTTONS**).

When the main display is showing (the one that appears after powering up) the **FUNCTION KEYS** select the viewing mode (Performance or Sounds). In Sounds mode (as shown in the

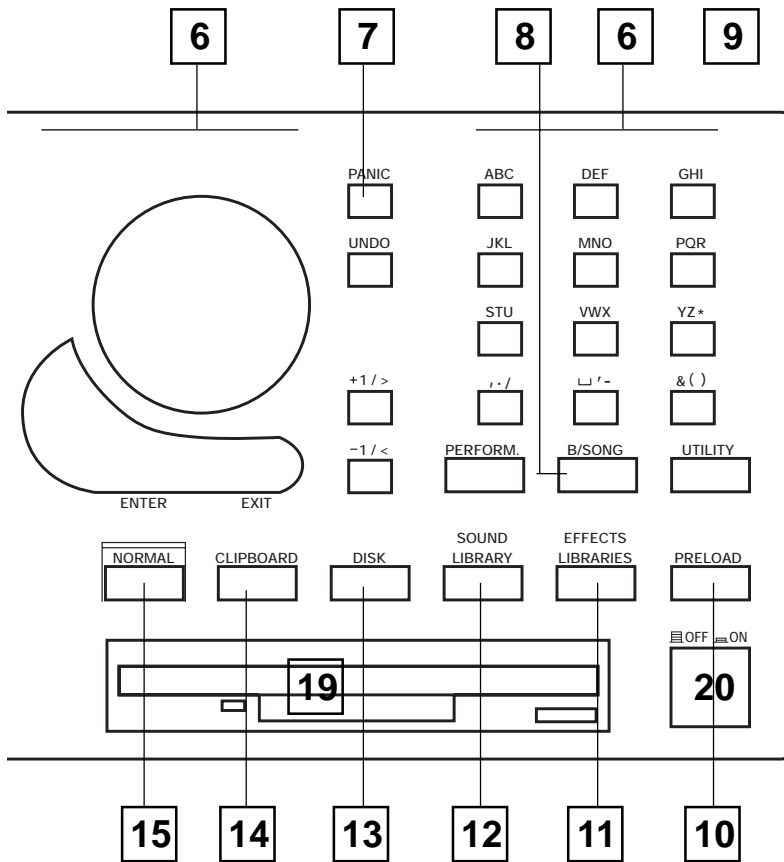

illustration), these buttons select the track playing mode (*Single, Multi...*). The **RIGHT MULTIFUNCTION BUTTON** gains access to the Save Performance command.

6. DATA ENTRY SECTION. This section is divided into two distinct parts:

- the **DIAL** can be rotated freely in both directions to change the current data value continuously, to change Performance or Sound, to move the reverse-highlighted cursor within the menu of the edit pages. The **+1/>** and **-1/<** buttons operate in exactly the same manner as the Dial, but with single increments.

ENTER confirms data entered or commands; in edit environments, it gains access to parameters that require modifications. **EXIT** annuls values inserted or cancels some commands.

Pressing ENTER when a main display is showing, or when the Sample Translator is active, will play a note (Sound Test).

- the **ALPHANUMERIC KEYPAD** is used to specify absolute numeric data or alphabetic data entry. For numeric data entry, confirmation with **ENTER** is always required. It is also used to gain direct access to the menu parameters in edit environments (without the use of **ENTER**).

The Data Entry section also makes use of the **UNDO** function. **UNDO** undoes or reverses the most recent action or restores the last saved situation. There is also an **UNDO** specific to the sequencer.

7. PANIC. Emergency button which sends an “All Note Off”, a “Reset Controls” and an “unlock” message to notes and controls “locked” by, for example, the reception of a “bad” MIDI event..

8. B/SONG and PERFORM. The **B/SONG** and **PERFORM** buttons permit the selection of one of the 10 Bank/Songs which can be present in the S2R memory and one of the 10 possible Performances contained in the selected Bank/Song.

9. UTILITY. Gains access to several useful applications: change Performance or Bank/Song name, cancel Bank/Song and Performance, copy Bank/Song and Performance.

10. PRELOAD. Allows background song loading (while the sequencer is in playback).

11. EFFECTS LIBRARIES. Storage facilities for the Effects, one for the Reverberations and another for the Modulations.

12. SOUND LIBRARY. An archive which stores all the Sounds in the instrument’s memory. Incorporated are functions which permit the importation of single Sounds from floppy disks which contain other Sound Libraries (imp_disk and imp_ramd).

13. DISK. Gains access to all the data handling procedures on floppy disk and Ram-disk. The operations are Load, Save, Erase and a Utility menu with several functions (Format, Disk Name, MIDI-file conversion).

14. CLIPBOARD. An application which allows “clips” of edit situations to be stored and used in other edit environments to save time.

15. NORMAL. Returns to the main display from any situation.

16. CONTRAST. Controls the brightness of the display and requires adjustment for different angles.

17. EFF. BYPASS. A temporary deactivating device for the Effects (led on) - the sounds are emitted “dry” from the Stereo Left & Right Outputs. Normally (led off), the sounds are emitted “wet” from this output pair.

18. TRACK TRANSPOSER. Individual and independent Track Transposer. Also provides the “Master” command which gains access to the general transposition of the instrument.

19. DISK DRIVE. Reads and formats 3.5” HD floppy disks (force-format to 1.62 Mb) for the saving and loading of S2/S3 data. Also formats, reads and writes on 3.5” DD floppies (Ms-Dos or Atari) for MIDI-file data exchange. Recognises and loads samples from Akai S/1000 format disks.

20. ON/OFF PUSH BUTTON. Press this button to turn S2R on or off.

REAR PANEL S2R

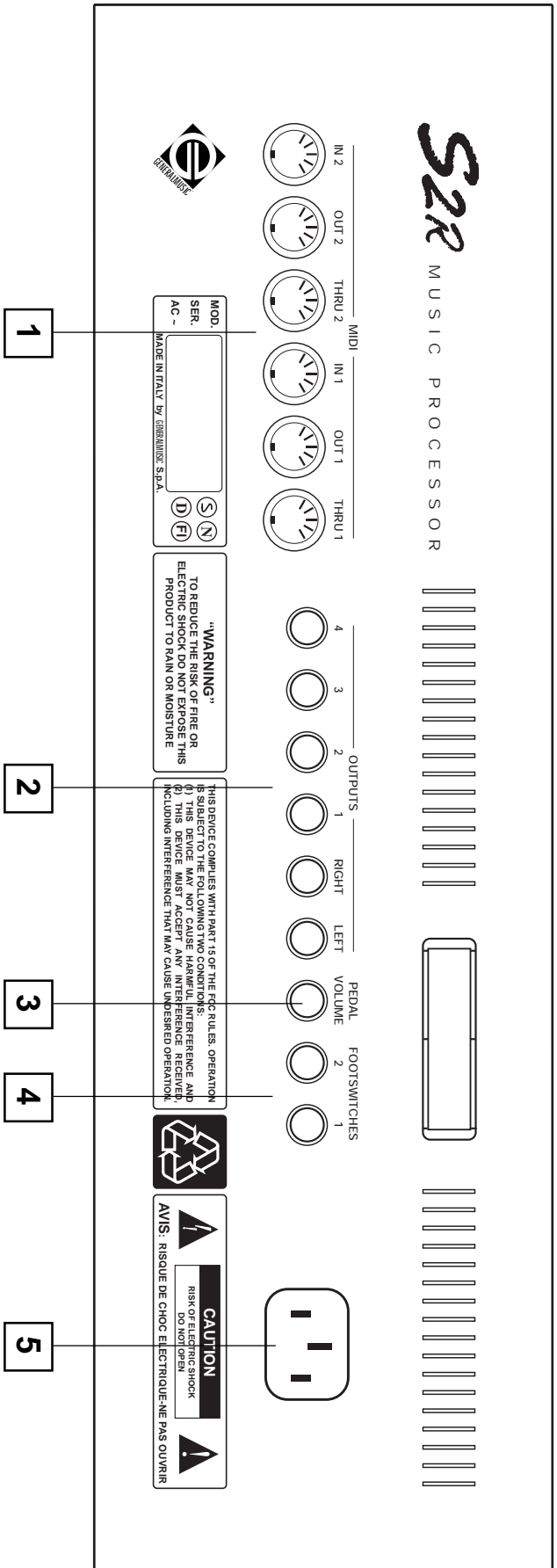

1. MIDI PORTS. A double series of MIDI ports: MIDI In 1&2, MIDI Out 1&2 and MIDI Thru 1&2. Set "1" are active by default. The MIDI ports ALLOW S2R to be controlled by external MIDI controlling units and allow slaved devices to be controlled by S2R.

IN 1 – IN 2: connections for any MIDI controlling device (master keyboard, sequencer, guitar controller, Midi Accordion ...).

OUT 1 – OUT 2: connections for instruments slaved to the S2R which can be controlled by S2R's internal sequencer. If MIDI-MERGE is active, these ports also transmit the MIDI data received at MIDI In.

THRU 1 – THRU 2: the data received at MIDI In escape from these ports.

2. OUTPUTS. Audio outputs which can operate as six separate mono outputs or as three stereo pairs.

LEFT/RIGHT: "wet" signal emitters. The instrument checks the insertion of the jacks;

if only one output is connected, the complete mono signal is emitted from the relative socket.

1, 2, 3, 4: "dry" signal emitters.

3. PEDAL VOLUME: Connection for a continuous control pedal to control the general Volume.

4. FOOTSWITCHES 1 & 2. Connections for Footswitch pedals (switch control pedals) to control parameters such as Damper, Start/Stop, Performance advance, etc..

5. MAINS SOCKET. Connect the supplied power cable to this socket. Connect the other end to an AC outlet of the correct voltage.

Warning: check for the correct voltage before connecting your instrument. The correct voltage is silk-screened close to the mains socket.

OVERVIEW OF THE INSTRUMENT EDITING & DATA HANDLING CAPACITY

-
- ❑ OVERVIEW OF THE INSTRUMENT
 - The Music Processor concept
 - Sound synthesis
 - Sources and Destinations
 - Tracks, Performances, Bank/Songs
-

- ❑ INTERNAL MEMORY AND DISKS
-

- ❑ OPERATING MODES
-

- ❑ OVERVIEW OF THE EDITING & DATA HANDLING ENVIRONMENTS

OVERVIEW OF THE INSTRUMENT

The Music Processor concept

The S Series instruments are so called because they are, as the name suggests, *processors of music*, a long step away from *synthesizer workstations*.

These instruments allow the creation of new sounds (as in synthesizers), the creation of Songs and the possibility of simplifying the unit's programming tasks in live

situations (as in workstations), they incorporate a sophisticated MIDI implementation, which allow them to operate as a control centre in the studio as well as on stage, operating as a programmable master keyboard or a MIDI processor with powerful MIDI Thru and MIDI Merge functions.

Sound synthesis

The sound generation of the Generalmusic S Series instruments utilises a hybrid system based on sampling and subtractive synthesis, all digitally controlled.

- Sampling guarantees a high degree of sound authenticity, indispensable for the simulation of multi-instrument situations as well as for the simplification of sound creation starting from common timbral sources.
- The part relating to subtractive syntheses allows sounds of real or synthetic origin to be subjected to the action of one or two programmable filters, which deeply intervene on the harmonic content of the original sound, rendering it extremely "live".

Sampling

Sampling technology is a technique of recording sounds "live", which permits the reconstruction of the original acoustic instrument using an electronic musical instrument.

The development over time of the intensity of a sound is represented by the envelope. The Envelope of a sound - any sound - can be represented graphically in the following manner:

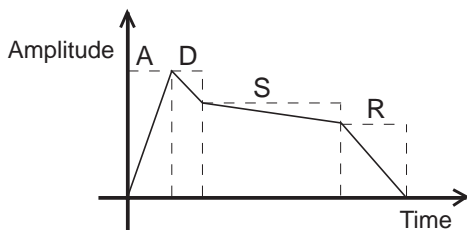

"Amplitude" measures the intensity reached by the sound within a certain period of "Time". The letters A, D, S, R indicate the various phases of the sound's development:

- A the Attack phase, which starts from the moment of the initial sound emission (key on) to the moment of maximum intensity. [\rightarrow Attack]
- D the Decay phase, in which the emission starts to "fade" after reaching the maximum peak. [\rightarrow Decay]
- S the Sustain phase (sound "prolongation"), where, after the first turbulent instances, the emission tends towards stabilisation (e.g. Strings) or reduction (e.g. Piano). [\rightarrow Sustain]
- R the Release phase, which proceeds from the moment in which the action of the musician terminates (note off), and the emission continues towards total silence. For example, when a piano key is released with the right pedal held down. [\rightarrow Release]

Sampling records the entire attack and decay phases and only a part of the sustain phase, while the release is completely ignored. This limitation in sampling is due to the fact that the recording of a sound occupies RAM, which, being costly, cannot be exploited to record the entire envelope. The better the quality of the sample, the more RAM is required to contain it.

The "missing parts" are substituted by intervening on the recorded part with the musical instrument. The sustain phase is electronically simulated by repeating a sampled fragment. This repetition of the sampled fragment in the sustain phase is called the "Loop".

The loop, however, often generates a "defect" created by the interaction of the terminal and initial points of the sampled fragment - similar to what is heard when the needle of a vinyl disk jams.

The problem derives from the fact that the "loop" is only one element, based on a single fragment of the sustain phase. To overcome this problem, Generalmusic have adopted an innovative system called the "Multiloop"

technique, which is the sampling of 8 minute fragments of the sustain phase.

In sounds generated by two paired oscillators, the S Series reads the loops alternately with increasing fading (“crossfade”) between the two oscillators. Crossfading completely eliminates the disturbances created by the loop.

Waveforms

When an acoustic sound is sampled and played on a keyboard, the sound can only be used on notes that are close to the sample note. The greater the distance from the sample note, the more inferior the quality of the sound.

By combining a series of samples at various frequencies along the scale, otherwise called a multisample, you obtain a Waveform.

The high authenticity of the S Series sounds is due to the fact that they are based on Waveforms consisting of several Samples which cover the frequency extension of the original acoustic instrument.

Filters and Sounds

All sounds consist of a band of harmonics; very simple sounds that, when combined with one another, contribute to the production of a complex sound (the sound actually heard). The harmonic band can be analysed with the Fourier diagram:

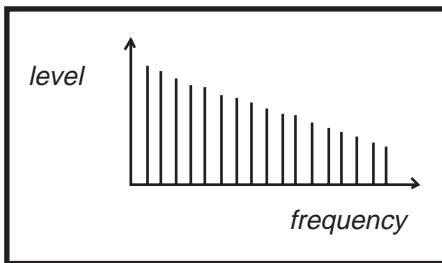

The diagram shows the harmonic bands along the “frequency” axis and the length of the bars that represent them correspond to their intensity (“level”) and to their importance in the sound that we hear. The harmonic band shown with the greater intensity is known as the fundamental and its pitch coincides with the audible sound.

The harmonic band is called the “timbre”. The timbre of a double bass differs to that of a trombone, because their respective harmonic bands are different. If some harmonics are removed, or their intensity altered, the timbre of the sound also changes.

The technique of synthesis incorporated in S Series instruments treats the Waveforms in the same manner as the “old” analog synthesizers, which intervened on the elementary waveforms (sinus, square, saw-tooth). The Waveform is modified by the action of one or two filters [→*DCF*]. These filters attenuate or enhance several harmonics. The example shows how the higher harmonics of a sound are “filtered” and attenuated until they disappear:

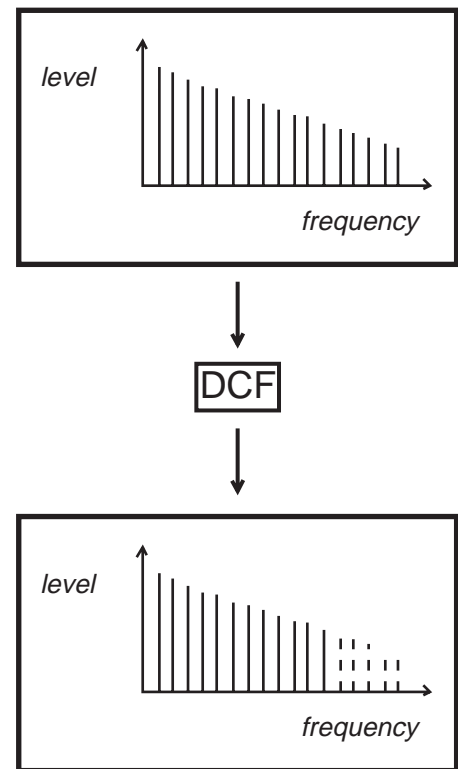

The filters intervene on the Waveform by modifying the harmonic band and consequently its timbre. The filters of the S Series are programmable and they can change in time with an envelope, as occurs with the intensity of the sound.

The sound processed by the S Series filters is called, simply, a *Sound*, and this constitutes the basic sonic material.

Bank/Songs and Performances

The Sounds can be combined to form “Performances”, and stored in slots called “Bank/Songs”.

Up to 10 Banks of 10 Performances each can be memorised in the Music Processor’s RAM, a total of 100 multi-timbral Performances.

Performance

The Performance is a combination of several tracks with various “playing” parameters (volume, pan, programmed pedal configuration, DSP activation.....).

In the Performance, a Sound and/or a MIDI OUT channel is assigned to each Track. For each Track, it is possible to independently programme various parameters (example: the volume and pan).

In practice, the Performance is a combination of several Sounds “mixed” in order to obtain a complex sound to use live, or a multi-timbral combination to use in a Song, or another multi-timbral combination that can be

controlled by data received at MIDI In.

The Performance, therefore, is a “global setting” corresponding to a complex instrumental setup, recalled instantly while playing or while recording a Song.

Bank/Song

The Bank/Song consists of two parts: a bank of 10 Performances and a Song. The Song exploits the Performances of the Bank to which it is associated.

The sequencer controls which control the Song playback are situated under the display:

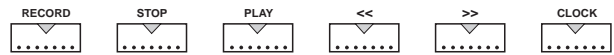

The Music Processor can store up to 10 Bank/Songs in RAM.

Tracks

The Track playing mode

Each Performance consists of a maximum of 16 tracks which can be arranged in various different ways. The way in which the tracks can be arranged is called the “playing mode”.

There are four track playing modes:

- *single* is a single track situation;
- *multi* is a multitrack combination;
- *layer* is an overlapping paired track combination;
- *split* is a combination of two tracks which divide the keyboard.

Each Performance can simultaneously memorise four different track playing modes, one for each of the four possible origins (Sources) of MIDI events (Source *s. further ahead*).

For example, the Track playing mode for the Local Source could be set to *Single* mode, in order to play a piano Sound with the keyboard; for the Song Source, the Track playing mode could be set to *Multi*, so that the internal sequencer could play a 16 part multi-timbral song.

To view the playing mode set for each Source, press the relative button in the “Source” section: by pressing one

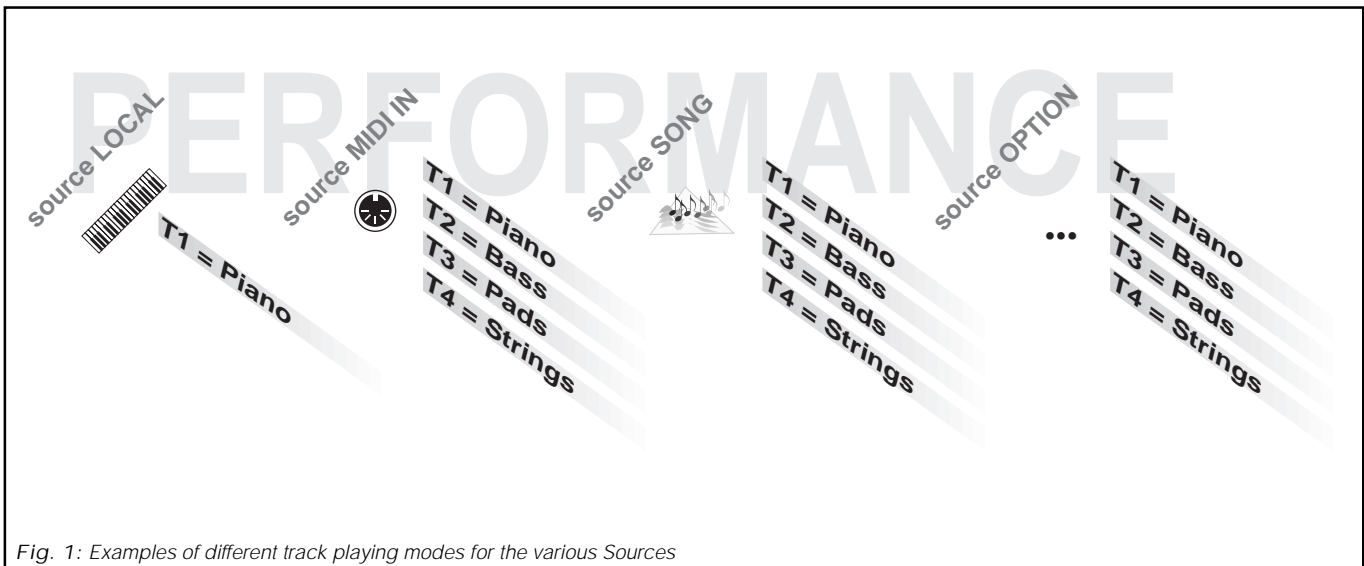

Fig. 1: Examples of different track playing modes for the various Sources

of the buttons, the main display will change to show the track playing mode for the selected Source.

Track configuration

Each track can be connected to or disconnected from one or more Sources and to/from the track data Destinations.

For example, if track 1 is connected only to the Local Source (keyboard or master keyboard) and only to the destination “Generation” (internal Sound engine), the keyboard will be able to play one of the Music Processor Sounds. The remaining fifteen tracks could be connected to the MIDI IN Source and to both the Destinations “Generation” and “MIDI OUT”, in order that an external controlling device can play the Music Processor Sounds and transmit the MIDI messages from the Music Processor’s MIDI OUT to play an external expander.

The Track Configuration, therefore, is a network of connections between Sources and Destinations.

Multi-timbral

To each of the 16 tracks, it is possible to assign a Sound and/or a MIDI channel with which you can pilot another musical instrument. In practice, the Music Processor is a combination of 16 different instruments. Instruments able to operate with several different channels are otherwise known as *Multi-timbral* instruments.

The mixer

The MIDI data that converge on the tracks are processed as in a mixer. Before being sent to the Destinations, they are processed by the volume and transposition controls and by the stereo panorama positions (*Pan*).

The MIDI data are also processed by a MIDI Delay which retards the sending of the data to the Destinations, creating a situation of “postponed playing”, used to generate replay effects between the tracks.

The Sounds are directed to the two DSPs (*effects processors*) which further process the signals by adding reverberation, delay, chorus, echo or rotary to the Sound of each track.

Furthermore, the pitch of each track is individually programmed to obtain octave “duplication” or pitch adjustments.

Finally, the MIDI data are sent to MIDI OUT, with the volume and pan settings, while the Sounds are destined to the Audio Outputs and, subsequently, to an external amplifier (*Fig. 2*).

“Mute” and “Solo”

As in any respectable mixer, the tracks in the S Series can be “muted” directly from the principal display. This condition is a temporary disconnection of the Source which finds its use in many applications. For example, while a Song is in playback mode, you can mute some tracks of the **Song** Source to listen to those remaining. The same applies to the other Sources: you can mute tracks of the **Local**, of the **MIDI In...**

Another function, “SOLO”, operates in an inverse manner: it isolates a single track in multitrack situations, permitting you to hear the selected track while all others are muted.

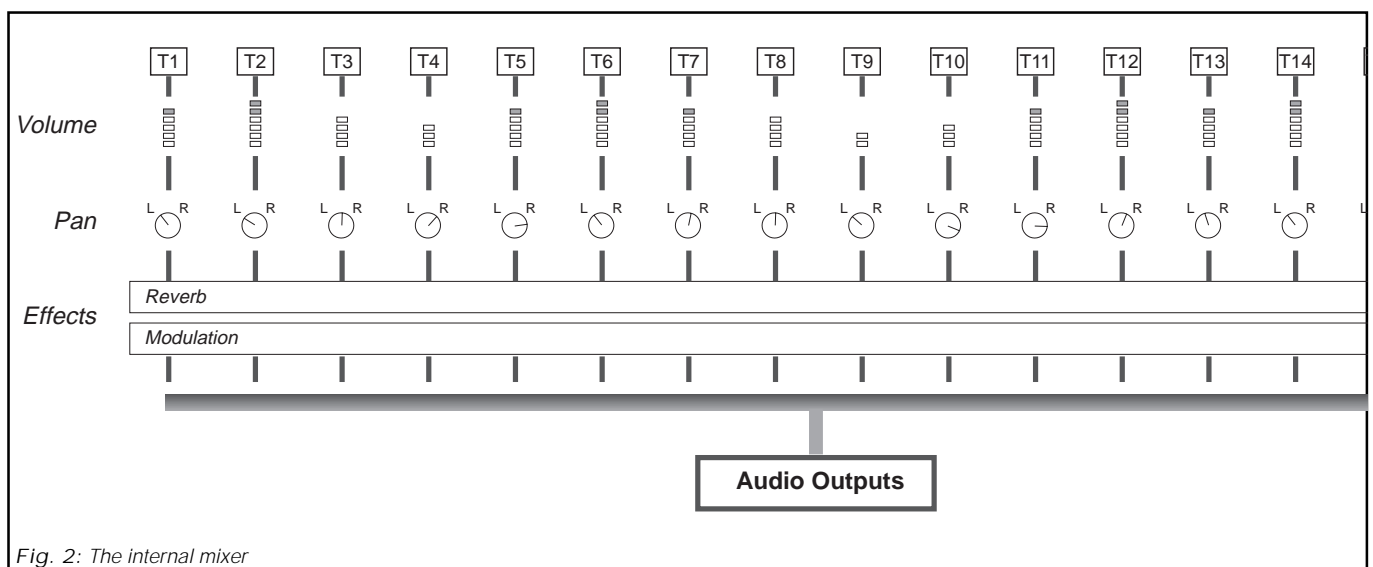

Fig. 2: The internal mixer

Sources and Destinations

MIDI events

A master keyboard or a sequencer sends a string of MIDI data to the Music Processor's computer; these are instructions on the way in which the Sounds must be played. The MIDI data can also be recorded by the

Music Processor's internal sequencer (which is precisely a MIDI data recorder).

MIDI data, or "events", are generated by the Sources, they are controlled by the Tracks and, finally, they are sent to the Destinations: (Fig. 3)

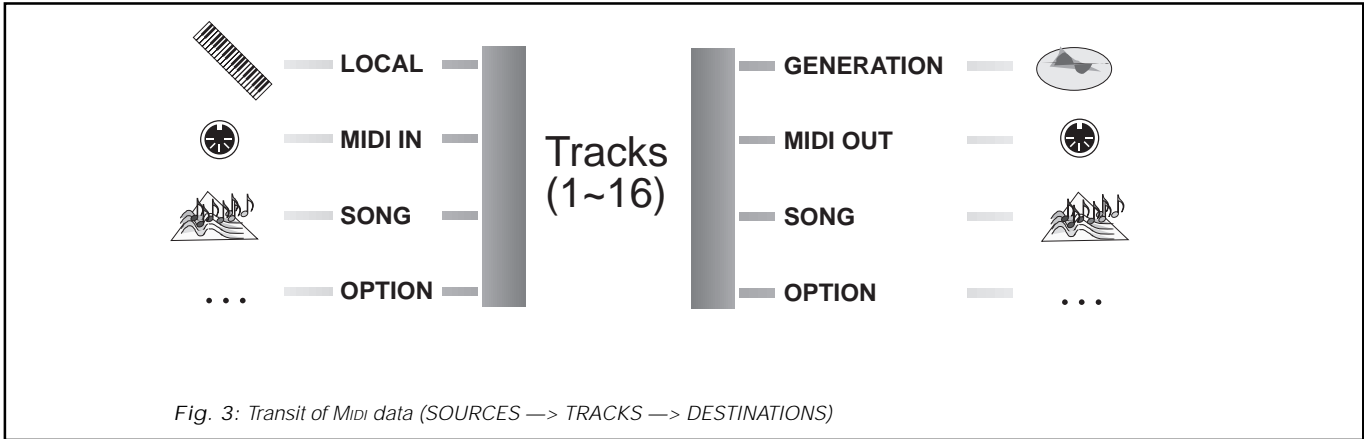

Sources

The Sources are the MIDI event generators. There are four Sources, each one corresponding to a device capable of generating the data:

- **LOCAL** keyboard or master keyboard (via MIDI-COMMON).
- **MIDI IN** data entering at MIDI IN (an external sequencer or a multi-split master keyboard).
- **SONG** internal sequencer.
- **OPTION** (left at the disposal of a User Program).

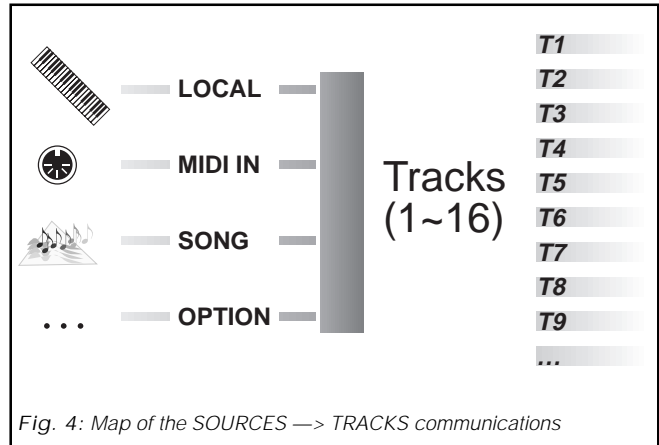

Destinations

The Destinations are where the MIDI data are sent. There are four Destinations, each corresponding to a sound generator or recorder of data:

- GENERATION** internal sound generator.
- MIDI** MIDI OUT ports.
- SONG** internal sequencer.
- OPTION** (left at the disposal of a User Program).

Tracks (1~16)	GENERATION	MIDI OUT
T1	GrandPiano	Out 1, Channel 1; ProgramChange 1
T2	StringsI	Out 1, Channel 2; ProgramChange 49
T3	AcousticBass	Out 1, Channel 3; ProgramChange 33
T4	Shakuhaki	Out 1, Channel 4; ProgramChange 78
T5	Nyl_Guitar	Out 1, Channel 5; ProgramChange 25
T6	Contrabass	Out 1, Channel 6; ProgramChange 44
T7	Timpani	Out 1, Channel 7; ProgramChange 48
T8	Trombone	Out 1, Channel 8; ProgramChange 57
T9	FrenchHorn	Out 1, Channel 9; ProgramChange 61
...

Fig. 5: Map of the TRACKS → DESTINATIONS communications

INTERNAL MEMORY AND DISKS

Overview of the data and the memorising facilities (floppy disk and RAM-disk)

As in any computer, the Music Processor is an elaborator of data, which consist of Sounds, Songs and any other element or parameter used during the elaboration or execution.

The data can be utilised for the purpose of elaboration for playing, or they can be memorised for future use.

The “physical environment” which houses the data during the course of an elaboration or execution is the RAM, or the instrument’s operative memory. The S Series RAM is divided into two parts:

- a) OPERATIVE-RAM, which is exploited by the micro-processor for every single operation, and which contains the Sounds, the Songs, the Performances and any other data necessary to make the instrument work;
- b) SAMPLE-RAM, which, while the instrument is on, contains the Samples loaded together with one or more Sounds or via the Sample Translator.

RAM is volatile: all the data it contains will be irretrievably lost when the instrument is turned off. Therefore, before turning off the instrument, this kind of data must be saved in devices capable of conserving the data intact for future use. These devices are the Floppy Disk and the Ram-disk.

The floppy disk is the classic diskette which is inserted in the instrument’s disk drive, and it serves to store your data and to exchange it with other people or other instruments.

The Ram-disk is a fixed internal device of the Music Processor, which serves to memorise all data at high speed. This device is an optional item which can be fitted upon request in all the S Series instruments, but it is highly advisable to install it to speed up the operations.

The exchange of data takes place in the direction Disks <—> RAM:

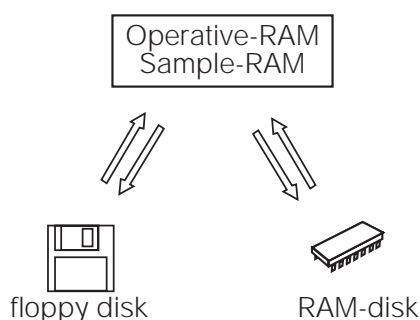

The data are organised in memory and in the disks according to the type and order of hierarchy.

The structure of the disk data is as follows:

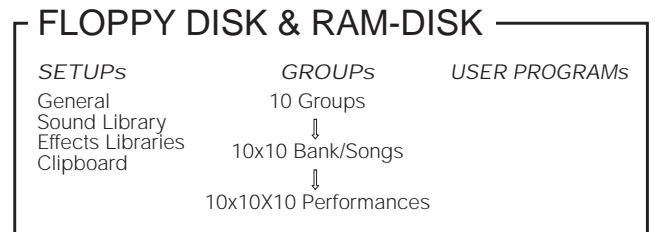

The structure of the data in memory is as follows:

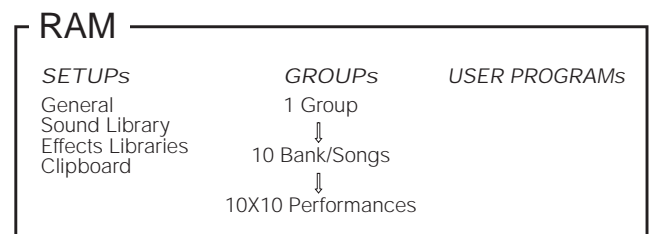

The data between memory and disk is completely exchangeable. The only data that can be read by the floppy disk and not saved are the User Programs.

The data

Setups Basic settings of the instrument. These include the General setups, the Sound Library, the Effects Libraries (reverbs/modulations), Clipboard (edit page “clips”).

Ram and disks are able to store only one Setup of the same type (only one Sound Library, only one General Setup...).

Groups Bank/Song groups. Only one Bank/Song group can be loaded at a time from disks containing up to 10 Bank/Songs.

User Programs Programs which provide the instrument with new functions.

MODES OF OPERATION: *NORMAL, EDIT/HANDLING*

The instrument has two operating modes: *normal*, which is the operating mode dedicated to playing, and *edit/handling*, which permits the modification of data, its memorisation and its organisation for future use.

Normal operative mode

The instrument powers up in Normal mode, which allows the primary control of the instrument through the main display.

The main display can show the Performance (allowing high speed selection), or it can show the Sounds assigned to the tracks which make up the Performance (allowing their selection at high speed):

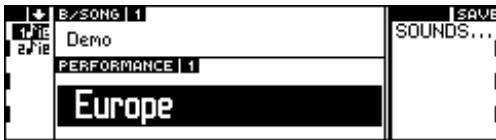

Main display - Performance mode
(default situation)



Main display - Sound mode

Edit/Data Handling mode

The Edit/Data Handling mode is activated by pressing one of the buttons of the “Edit” section (PERF. CONTR, PERF. TRACKS, SONG, SOUND, GENERAL) or one of the buttons that recall data handling situations (DISK, UTILITY, SOUND LIBRARY...).

Multitasking

The S Series operating system is one based on multitasking, making it possible to work in different parts of the instrument simultaneously.

For example, while you are playing back a song, you can load another (*background* loading), or while you are performing editing tasks on a sample with the Sample Translator, you can temporarily escape edit mode to program a Performance or modify the transposition of a track without data loss.

OVERVIEW OF THE *EDIT/HANDLING* ENVIRONMENTS

EDIT, HANDLING, UTILITY ENVIRONMENTS

When you press one of the buttons of the “Edit” group (PERF. CONTR, PERF. TRACKS, SONG, SOUND, GENERAL) or one of the handling or utility buttons (SOUND LIBRARY, EFFECTS LIBRARIES, DISK, PRELOAD...) you will gain access to one of the *edit/handling* displays.

The structure and constituting elements are common to all the edit/handling displays. The common elements are the *pages*, the *menus* and the *commands/options*.

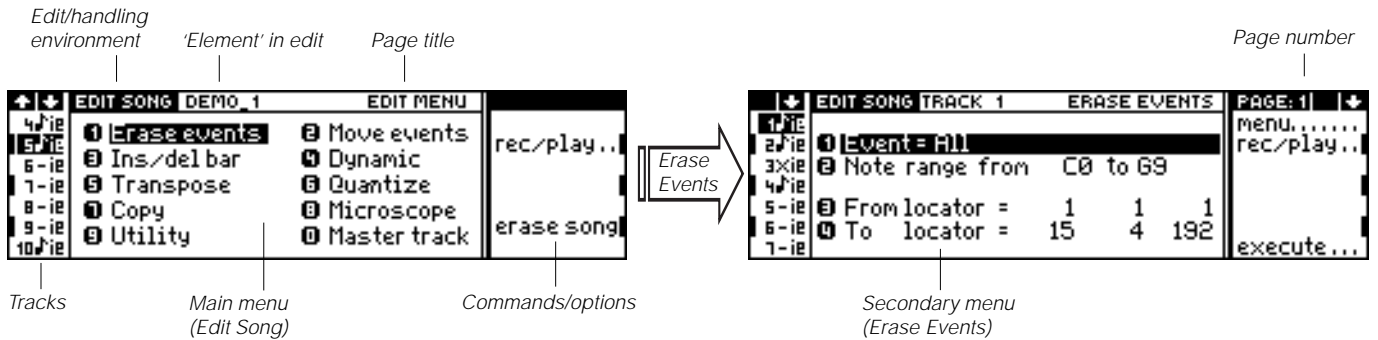

The pages

Pages are displays which contain a menu or a series of parameters. Some environments consist of only one page, others can contain more than one.

For example, the Disk environment distributes the four principal Disk functions across four pages: Load (page 1), Save (page 2), Erase (page 3), Utility (page 4).

The presence of more pages is shown by one or two arrows in the top right hand corner of the display, each corresponding to one of the multifunction buttons:



(The appearance of one arrow means that the current page is the first or last, and it is not possible to advance further).

To return to the previous page, press the left multifunction button; to advance to the next page press the right multifunction button.

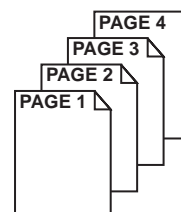

The menus

The structure and selection of the menus

The list of parameters, functions, procedures, etc. shown at the centre of a page is called the *menu*. The following display shows the main menu of the Edit Sound environment:



To select a menu item, you can choose from two methods:

- select the item with the DIAL and press ENTER;
- specify the corresponding menu item on the alphanumeric keypad (for direct and instant access).

Main menu and secondary menus

Some environments consist of several pages, without secondary menu levels (example: Disk).

Other environment present a *main menu* which contains various environment modules. By selecting one of the modules, you gain access to a *secondary menu* which contains a set of parameters or functions (example: Edit Sound):

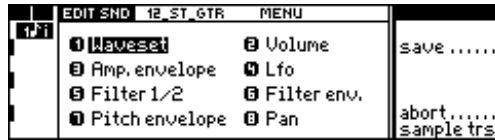

Edit Sound, main menu

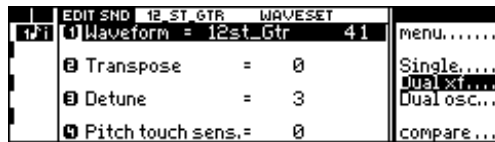

Edit Sound, secondary menu relating to the Waveset module

Secondary menus show the "Menu" command, which returns to the main menu.

Commands/options

The commands and/or options appear in the right column of the various environments. These are selected

with the function keys and the items displayed vary according to the environment and/or the page currently showing.

Parameters

The edit pages (Performance, Sound...) which do not have secondary menus contain, instead, a list of editable parameters which are broken down into three types: *simple*, *multiple*, *graphic*.

Simple parameter

This consists of a single element which can be modified:

```
1 Waveset = 12st_Gtr 41
```

Use the following procedure to edit the parameter:

1. Select the parameter with the DIAL and press ENTER to activate the edit; or specify the parameter number on the ALPHANUMERIC KEYPAD to gain direct access to the edit:

```
1 Waveset = 12st_Gtr 41
```

2. To modify the parameter value, rotate the DIAL; or specify the new parameter value on the NUMERIC KEYPAD (in some cases, "ENTER" is necessary to confirm the value specified, *s. User Interface* section, chapter *Data Entry devices*).
3. Escape from the parameter edit with ENTER (to confirm the new value) or with EXIT (to annul the modification):

```
1 Waveset = Jazz_Gtr_1 42
```

Multiple parameter

This consists of several editable parts:

A Amplitude = 1 Touch sens. = 3

Press enter repeatedly to access each following part of the parameter. Follow this procedure:

1. Select the parameter with the DIAL and press ENTER; or specify the corresponding number on the ALPHANUMERIC KEYPAD.

The first part of the parameter is placed in edit:

A Amplitude = 1 Touch sens. = 3

2. To modify the first part, rotate the DIAL; or specify the new value on the NUMERIC KEYPAD.
3. Press ENTER to gain access to the edit of the next part:

A Amplitude = 2 Touch sens. = 3

4. To modify the second part, rotate the DIAL; or specify the new value on the NUMERIC KEYPAD (ENTER may be necessary to confirm the value entered).
5. Escape from the parameter edit with ENTER (to confirm the new value) or with EXIT (to annul the modification):

A Amplitude = 2 Touch sens. = 2

Graphic parameter

This consists of several simple parameters and graphic representations of their interaction.

There are several different types of graphic parameter: track configuration, envelopes, tracking. In all cases, the “objects” are selected by rotating the dial and access to the edit is gained by pressing enter.

In some cases (envelopes, tracking) the graph also shows a line of numerical value of an explanatory or subsidiary nature.

For example, modify the “Key On Envelope” graph:

1. Enter Edit Sound, select the Amplitude Envelope module and open the second page.

The display appears are shown in the previous drawing. Each “Segment” corresponds to one of the segments of the envelope. The segment’s duration (Time) is represented by the horizontal axis and the sound’s intensity (Level) by the vertical axis.

2. The “Segment” parameter is shown selected. Rotate the DIAL to select one of the segments of the envelope.
3. Press ENTER to select the “Time” parameter.
4. Rotate the DIAL to modify the “Time” value. Or, specify the value on the NUMERIC KEYPAD (press ENTER to confirm or EXIT to annul).
5. Press ENTER to select the “Level” parameter.
6. Rotate the DIAL to modify the “Time” value. Or, specify the value on the NUMERIC KEYPAD (press ENTER to confirm or EXIT to annul).
7. Select “Menu” to return to the main menu (Function Select Key A). To escape Edit Sound, select the “Abort” command with Function Select Key F.

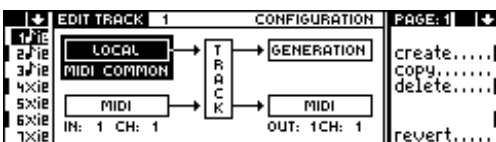

Edit Performance/Tracks, page 1. “Configuration” graphic parameter.

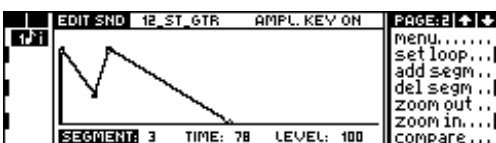

Edit Sound, module AMPLITUDE ENVELOPE: Graphic Parameter “Key On Envelope”

Note: If you escape an edit/handling environment while a parameter is currently in edit, the parameter will remain in edit. If you change page while the parameter is still in edit, the modification is confirmed and you will escape the edit of the parameter.

A Waveform = 12st_gtr 41

a - If you escape edit, the parameter will remain like this.

b - If you change page, the parameter will be confirmed.

A Waveform = 12st_gtr 41

Escape from *EDIT/HANDLING*

Two possibilities are available: (1) possibility of escaping without confirmation, (2) necessity of escaping with confirmation or cancellation of the modification.

To escape from Edit Performance, Edit Song, Disk, Sound Library, Preload... press the button which gains access to the environment, or press the **Normal** button.

From Edit Sound, Edit Sound Patch, Edit Effect, Sample Translator, you escape by confirming or annulling the modifications applied to the data. In the commands/option column, the two possible choices are always shown: “Save” or “Abort”.

“Save” memorizes the modifications, “Abort” cancels them.

The “Are you sure?” display

As a security measure, before the instrument memorizes or cancel the changes, confirmation of the operation is always requested. When you select either “Save” or “Abort”, the following display is shown:

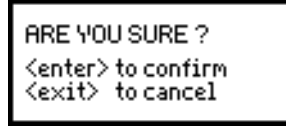

Analysis of two *EDIT/HANDLING* ENVIRONMENTS

Analysis of the ‘EDIT SOUND’ edit environment

EDIT SOUND shows a *main menu* with several different *editors* (each one corresponding to a Sound element):

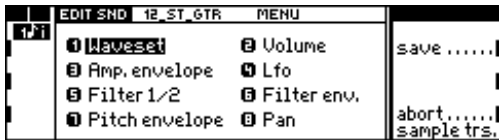

EDIT SOUND, main menu

Each editor gains access to a *page* containing several parameters. Some editors are composed of several pages. For example, the Amplitude Envelope editor contains four pages:

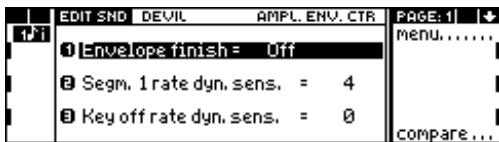

AMPLITUDE ENVELOPE editor, page 1

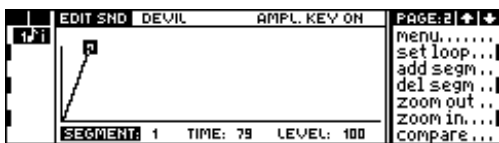

AMPLITUDE ENVELOPE editor, page 2

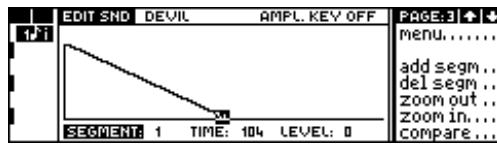

AMPLITUDE ENVELOPE editor, page 3

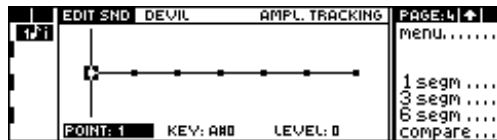

AMPLITUDE ENVELOPE editor, page 4

Every page of the various editors shows the “Menu” command which returns to the main menu, where you can select another module.

While you are in Edit Sound, you can select another Edit environment, open its entry level page and access the relative functions. When you return to Edit Sound by pressing the Sound button, the situation shown will be exactly the same as it was when you left. During the temporary escape, the led on the Sound button will flash as a “reminder” that you have some unfinished work to do.

To escape from Edit Sound, press the Sound button, or (if a modification has been applied to the Sound in edit), select the “Save” command to save the changes or “Abort” to cancel.

Analysis of the 'DISK' handling environment

Disk does not have any main menus: the relative functions are grouped in four pages according to homogeneous criteria:

DISK		LOAD	PAGE:1
1-IE	1	Load all	DISK
2-IE	2	Load all setup	ram.d
	3	Load single setup	*
	4	Load all bank/song	new disk ..
	5	Load single bank/song	directory..
	6	Load user program	

Disk, page 1 ("Load")

DISK		SAVE	PAGE:2
1-IE	1	Save all	DISK
2-IE	2	Save all setup	ram.d
	3	Save single setup	1*
	4	Save all bank/song	new disk ..
	5	Save single bank/song	S.compr....
	6		directory..

Disk, page 2 ("Save")

DISK		ERASE	PAGE:3
1-IE	1	Erase all	DISK
2-IE	2	Erase all setup	ram.d
	3	Erase single setup
	4	Erase all bank/song	new disk ..
	5	Erase single bank/song	directory..
	6	Erase all B/S groups	

Disk, page 3 ("Erase")

UTILITY		BANK/SONG	DEMO_7
1-IE	1	Bank/song name	
2-IE	2	Performance name	
3-IE	3	Delete bank/song	
4-IE	4	Delete performance	
5-IE	5	Delete clipboard	
6-IE	6	Copy bank/song	
7-IE	7	Copy performance	

Disk, page 4 ("Utility")

Access to a function is gained the instant it is selected.

To escape Disk mode, press DISK or NORMAL.

INSTALLATION, POWER UP, DEMO

CONNECTING THE MAINS CABLE

CONNECTING THE AUDIO CABLES

S2R: MIDI CONNECTIONS

POWER UP

S2R: "SOUND TEST"

DEMO

Connecting the power cable

Connect the power cable to the appropriate socket on the instrument's rear panel. Insert the plug into an A.C. mains outlet of the correct voltage.

Warning: The voltage of the instrument is shown on the small plate close to the power socket on the rear panel. Make sure that the voltage indicated corresponds to your mains supply voltage.

Connect the Audio cables

Connecting to an external amplification system

To connect to an external amplification system, use standard 1/4" jacks connected to the OUTPUTS rear panel sockets.

Stereo connection	Connect the LEFT and RIGHT sockets to the amplification system.
Mono connection	Connect the LEFT <i>or</i> RIGHT socket to the amplification system, leaving the other output free.
Separate outputs	(The outputs will require appropriate programming in EDIT PERFORMANCE/TRACKS, in order to direct each track to a single output or to an output pair. <i>S. Reference</i>).

Warning: Always connect audio cables with the amplifier's volume setting set to its lowest level or when it is switched off, in order to avoid unwanted noises or damage to the audio setup.

Stereo headphones

Connect a set of stereo headphones to the instrument's headphone socket.

S2R: CONNECTING TO A MASTER KEYBOARD OR TO AN EXTERNAL SEQUENCER

Connecting to a Master keyboard

Connect the MIDI PORTS

Connect the master keyboard's MIDI OUT to the S2R's MIDI IN.

For normal use, connect the S2R's MIDI IN 1, MIDI OUT 1, MIDI THRU 1 ports. The MIDI IN 2, MIDI OUT 2 and MIDI THRU 2 ports require appropriate programming in EDIT PERFORMANCE/TRACKS.

Connecting to a monosplit master keyboard (via MIDI-COMMON)

In monosplit mode, the master keyboard can be used as an integrated keyboard for the S2R. The Midi-Common is a special channel which permits the complete control of S2R with the master keyboard. When S2R is controlled via Midi-Common, it becomes the S2/S3 equivalent.

The master keyboard generates LOCAL events (it becomes the LOCAL Source). To see the status of the S2R tracks being controlled by the master keyboard, the led on the LOCAL Source button must be on.

S2R powers up in Midi-Common mode (by default) with channel 1 assigned to the Midi-Common. Program the master keyboard to transmit on Midi channel 1.

If, for technical reasons, the master keyboard cannot use channel 1 for MIDI-Common, program the S2R MIDI Common to the same channel assigned to the master keyboard (*s. EDIT GENERAL - MIDI in the Reference section*).

MIDI-COMMON	Active, MIDI CHANNEL 1.
Source	LOCAL.

Connecting to a multisplit master keyboard

In multisplit mode, each split of the master keyboard can control one of the S2R tracks. By default, the S2R tracks are set with Midi channel numbers corresponding to the track numbers (track 1 = channel 1, track 2 = channel 2...). To activate this setting, it is sufficient to deactivate the Midi-common channel (off).

In this situation, the master keyboard acts as the MIDI IN Source. To see the status of the S2R tracks being controlled by the master keyboard, the led on the MIDI Source button must be on.

The procedure required to deactivate Midi-common is explained in the section at the end of this chapter.

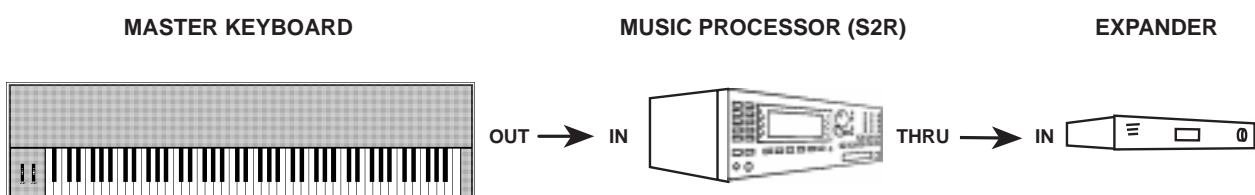

Connection of a master keyboard to S2R. The optional connection Thru—In between S2R and another expander will also allow the master keyboard to control the additional expander.

MIDI-COMMON	Deactivated (Off)
Source	MIDI IN.

Connecting to an external sequencer

The external sequencer can be a hardware sequencer or a computer, fitted with a Midi interface, which runs a sequencing programme.

Connecting the MIDI ports

To control S2R with the external sequencer, connect the sequencer's Midi Out to the S2R Midi In. To exchange songs (in both directions) between both units, connect the sequencer's Midi In to the S2R's Midi Out.

For normal use, connect the S2R's MIDI IN 1, MIDI OUT 1, MIDI THRU 1 ports. The MIDI IN 2, MIDI OUT 2 and MIDI THRU 2 ports require appropriate programming in EDIT PERFORMANCE/TRACKS.

Check the track status of the MIDI IN Source

In this situation, the sequencer is the MIDI IN Source. To check the status of the S2R tracks controlled by the sequencer, the led on the Midi In button in the Source section must be on.

DEACTIVATION OF MIDI-COMMON

This kind of setup requires that the Midi-Common be deactivated (off) in order to render the S2R tracks individually accessible. The procedure required to deactivate the Midi-common channel is shown at the end of this chapter.

MIDI-COMMON	Deactivated (Off)
Source	MIDI IN.

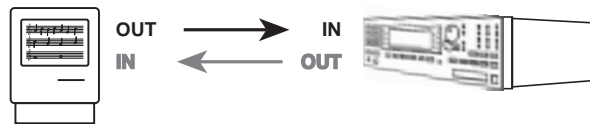

Sequencer connection—S2R. In—Out is optional.

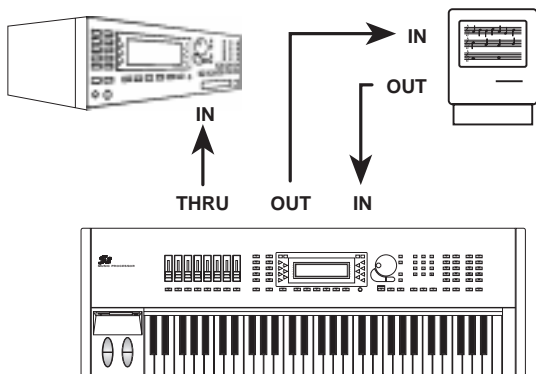

Possible connection master keyboard—sequencer—S2R.

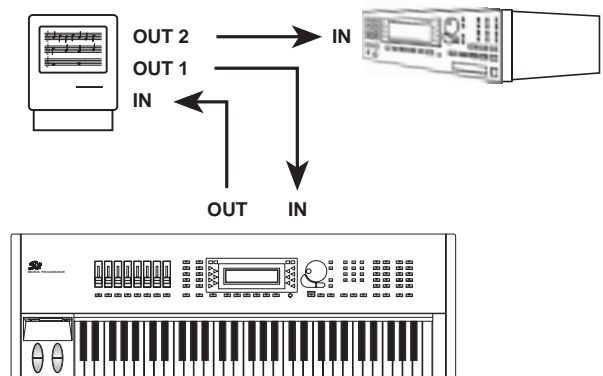

Possible connection master keyboard—sequencer—S2R.

How to deactivate the MIDI-COMMON channel

1. Enter Edit General by pressing the General button in the Edit section:



2. Specify 3 on the numeric keypad to gain access to the "Midi" function:



3. Specify 1 to enter the edit of the "Midi Common" parameter:

Midi common = ch: 1 In: 1 Out: 1

4. To deactivate MIDI-COMMON specify 0 (off) and press ENTER:

Midi common = ch: Off In: 1 Out: 1

5. To confirm the new status, press ENTER three times:

Midi common = ch: Off In: 1 Out: 1

6. Press NORMAL to return to the main display:



Save the MIDI-COMMON STATUS TO DISK

The new Midi-Common status will be lost when the instrument is turned off. When you power up again, the default status (Midi-Common active on channel 1) will be restored.

To avoid repeating the Midi-Common deactivation procedure, you can save the setting to a floppy disk so that, when you power up with the disk inserted in the drive, the instrument will be set to the required status automatically.

Alternatively, if your S Series instrument is fitted with the Ram-disk, you can save the Midi-Common status to Ram-disk. When the instrument is powered up without a floppy inserted in the drive, the setting memorised in the Ram-disk will be recognised and the Midi-Common status will be programmed automatically.

The MIDI-COMMON status is saved using **Setup General**.

How to save the MIDI-COMMON status to floppy disk

- Phase a—Format the floppy disk

1. Prepare a new 3.5" HD floppy disk.
2. Press the DISK button to gain access to the Disk handling procedures:



3. Press the right MULTIFUNCTION BUTTON repeatedly until you reach the Utility page:



4. Specify 1 on the numeric keyboard to select "Format work disk (1.62 Mb)". The display shows a message which invites you to insert the floppy disk in the drive:

INSERT 'H.D.' DISK
<enter> to confirm
<exit> to cancel

5. Insert the floppy disk into the drive and press ENTER (or EXIT if you want to cancel the formatting procedure). A dialogue window appears where you can insert the name of the disk:

DISK NAME
█

6. For the moment, ignore the disk name and press ENTER to continue. "Are you sure?" appears asking for a re-confirmation of the formatting process:

```

ARE YOU SURE ?
<enter> to confirm
<exit> to cancel
    
```

7. Press ENTER to confirm (or EXIT to interrupt the formatting procedure).

“Wait please....” appears for the entire duration of the formatting process:

```

Wait please... [F]
    
```

□ Phase b—Save the “General” Setup

8. At the end of the formatting process, press the left MULTIFUNCTION BUTTON twice to reach the Save page:

```

DISK          SAVE          PAGE: 2 |<|>
-----
1 Save all
2 Save all setup
3 Save single setup
4 Save all bank/song
5 Save single bank/song
disk [ ] 1*
ram.d [ ] 1*
new disk ..
S.compr....
directory..
    
```

9. Specify 3 on the NUMERIC KEYPAD to gain access to the “Save Single Setup” procedure:

```

DISK NO DISK  SAVE          PAGE: 2 |<|>
-----
1 Save all
2 Save all setup
3 Save single setup
4 Save all bank/song
5 Save single bank/song
new disk ..
directory..
    
```

10. Specify 1 to select the “General” Setup.
11. With “Are you sure?” showing, press ENTER to confirm (or EXIT to annul).

Save the MIDI-COMMON status to the RAM-disk

1. Press the Disk button to gain access to the disk handling procedure:

```

DISK          LOAD          PAGE: 1 |<|>
-----
1 Load all
2 Load all setup
3 Load single setup
4 Load all bank/song
5 Load single bank/song
6 Load user program
disk [ ] 1*
ram.d [ ] 1*
new disk ..
directory..
    
```

2. Press the right MULTIFUNCTION BUTTON once to open the Save page:

```

DISK          SAVE          PAGE: 2 |<|>
-----
1 Save all
2 Save all setup
3 Save single setup
4 Save all bank/song
5 Save single bank/song
disk [ ] 1*
ram.d [ ] 1*
new disk ..
S.compr....
directory..
    
```

3. Select the ram.d option with the Function Select Key B:

```

DISK          SAVE          PAGE: 2 |<|>
-----
1 Save all
2 Save all setup
3 Save single setup
4 Save all bank/song
5 Save single bank/song
disk [ ] 1*
ram.d [ ] 1*
new disk ..
S.compr....
directory..
    
```

4. Select and access the “Save Single Setup” procedure:

```

INT MEMORY    SAVE SINGLE SETUP  disk.....
-----
1 General
2 Sound library
3 Effect library
4
SIZE 2 KB DATE 08/06/92 TIME 14:00
ramd.....
    
```

5. Press ENTER twice to save the EDIT GENERAL setup to Ram-disk.

POWER UP

Powering up with an empty disk drive and RAM-disk

Press the power switch to turn on the instrument.

When the Music Processor powers up with no disk inserted in the drive and no data saved to Ram-disk, the display shown below appears:

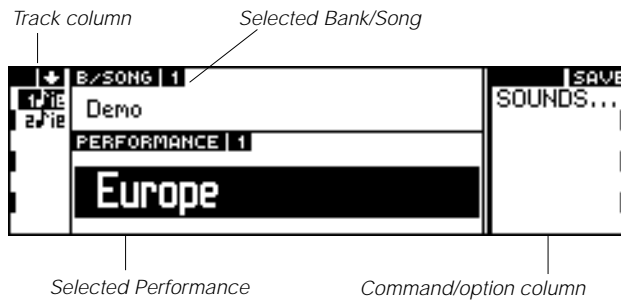

This is the **default display**, and it appears every time you power up with no disk inserted in the drive (and with an empty RAM-disk). This is the instrument's main display shown in "Performance" mode (*s.*). This display shows the name of the currently selected Performance and the name of the Bank/Song to which it belongs.

If you select the Sounds option (Function Select Key A), the display changes to "Sound" mode, which shows the name of the Sounds assigned to the tracks of the current Performance together with the relative Program Changes and Bank Select numbers:

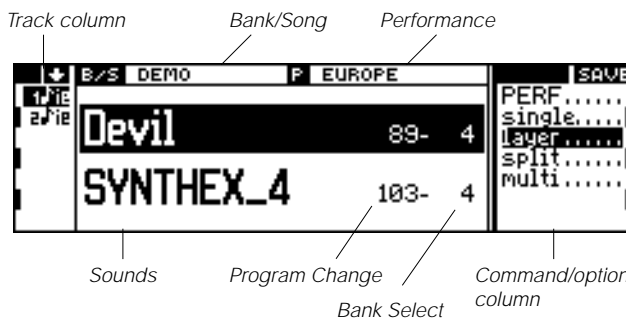

The button shown active (led on) in the Source section is LOCAL. When this button is active, the display is showing the status of the tracks for the Source LOCAL (keyboard, master keyboard via MIDI-COMMON). Close to the tracks that play, a small line appears, such as in a V-meter.

Powering up with a floppy disk inserted in the drive

If you power up when a floppy disk is inserted in the drive, the data contained in the disk will be automatically loaded into the instrument's Ram (operative memory). The data loaded:

- Bank/Songs and Performances
- Sounds (Sound Library Setup)
- Effects (Effects Libraries Setup)
- General Setup.

Powering up with data in the RAM-disk

If, at the moment of powering up, no floppy disk is inserted in the drive but the Ram-disk contains data, these are automatically loaded into the instrument's memory.

You can, if necessary, impede the reading of the Ram-disk data at the moment of powering up by pressing (and holding) the ENTER button for a few seconds an instant after pressing the "Power On" button.

Regulating the volume

As soon as you turn on, the instrument is ready to play. Regulate the overall volume using the MASTER VOLUME slider (S2R: the small VOLUME knob). If no sounds are heard, check one of the following possibilities:

- the volume of the amplifier may be incorrectly set.
- the audio or MIDI connections may have been incorrectly carried out.

Put the problem right. If all seem to have been carried out according to the instructions, perhaps there is a malfunction. *S. Troubleshooting.*

Before turning off the instrument...

...remember to save all your modified or created data (Song, Sound, Effects, Performance...). If you omit saving this data to floppy disk or to the RAM-disk, the instrument's Ram will empty when you turn off, cancelling all your edited data.

S2R: “SOUND TEST”

In the main display (set to “Sounds” mode) and in the Sample Translator, pressing ENTER activates the Sound Test, which allows you to listen to the Sound and check the MIDI OUT connection, regardless of the status of the keyboard (even if not connected).

Sound Test in the main display

If you press ENTER when the main display is showing “Sounds” mode, the Sound assigned to the currently selected track (in reverse highlight) will play:



Press ENTER to hear the Sound “Devil” and an expander connected to the S2R MIDI OUT.

You will also play the Sound assigned to the corresponding track of the expander connected to the S2R MIDI OUT.

The Sound Test can be programmed in the EDIT GENERAL environment:

1. Press the GENERAL button in the Edit section to gain access to EDIT GENERAL:

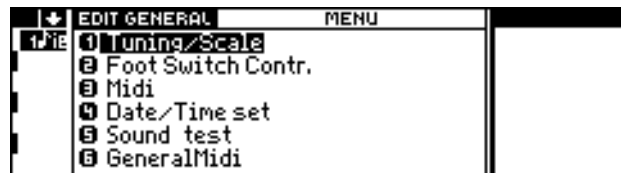

2. Specify the number 5 on the keypad to access the display Sound Test:

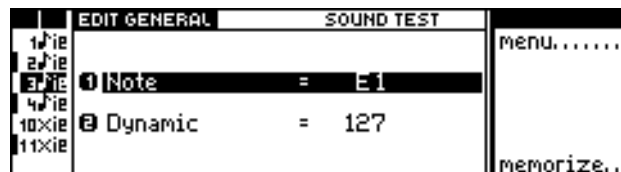

3. Modify the note and the dynamic value. The factory settings are, however, suitable for most situations.
4. Select the “Memorize” command with the FUNCTION SELECT KEY G. The setting will be permanently memorised until replaced by a new setting.
5. Return to the main display by pressing NORMAL.

Sound Test in the Sample Translator

In the Sample Translator pressing ENTER will play the note indicated by the “SR” parameter in the Info About display. The note is not sent to the MIDI OUT.

DEMO

The ROM demonstration Song

The non-volatile memory of the instrument (ROM) contains a demonstration Song, which is inserted to the “Bank/Song 1” slot automatically after powering up.

To listen to the playback of the Demo Song, simply press the **PLAY** button. To interrupt the playback, press **STOP**. To cancel the Demo Song from the “Bank/Song 1” slot, consult the Song and Sequencer chapters.

The “Demo Disk 01” and “Demo Disk 02” demo songs

Two floppy disks (“3.5” HD) are supplied with the instrument, both containing some Sounds and demonstration Songs.

Load the contents of “Demo Disk 01” automatically

With the instrument turned off, insert the floppy entitled “Demo Disk 01” into the disk drive and turn on the instrument. The display shows the name of the instrument and an animated clock. The disk drive is operating; it is loading the entire contents of the floppy disk into the Ram.

The loading time is approximately one and a half minutes. At the end of the loading period, adjust the volume level to a suitable setting. Check the volume level by playing some notes on the keyboard.

Play back the “Demo Disk 01” demo songs

Press the **UTILITY** button. The following display is shown (Utility display):



Press the **FUNCTION SELECT KEY D** (Juke-box) to start the sequencer: all the Songs contained in Ram will play one after the other (the “Juke_Box” command chains all the Songs contained in RAM).

Interrupt the “Demo Disk 01” demo songs

When the chained Songs reach the end, the Juke_box stops automatically. If you want to interrupt the playback at any point, press the sequencer’s **STOP** button:



Load the contents of “Demo Disk 02” in Ram

The first method consists in turning off the instrument, replacing the floppy “Demo Disk 01” with “Demo Disk 02” and repeating the procedure already explained for “Demo Disk 01”.

The second method consists in replacing the floppy “Demo 01” with “Demo 02” and using the Load All procedure, which loads the contents of the floppy disk in RAM.

After changing disk and inserting “Demo Disk 02” into the drive, press the DISK button:



Specify the number 1 on the NUMERIC KEYPAD to start the Load All procedure. Confirmation of the operation will be requested which, if given, cancels all the data already present in Ram, replacing it with the new data:



Press ENTER to confirm. The disk drive starts to operate and loads the entire contents of the “Demo Disk 02” floppy in RAM.

Playback the “Demo Disk 02” demo song

Press the PLAY button to listen to the single demonstration song contained in “Demo Disk 02”. Press STOP to stop the playback.

Cancel the “Demo Disk 02” demo song from the Music Processor’s memory

After listening to the demo song, turn the instrument off then on again before proceeding with the reading of the manual. All the songs previously loaded will be erased from memory.

USER INTERFACE / SELECTION

- DATA ENTRY
- DISPLAY AND ASSOCIATED CONTROLS
- MAIN DISPLAY / "SAVE PERFORMANCE"
- SELECTION
 - Select the Bank/Songs
 - Select the Performances
 - Select the Sounds
- CORRECT VIEW OF THE TRACKS
- TRACK PLAYING MODE
- PLAY, MUTE, SOLO

DATA ENTRY COMMANDS

The Data Entry commands permit the insertion of numerical and alphabetical data, the change of sound as well as various navigating tasks within the edit/data handling pages.

The Data Entry group consists of two distinct parts: the cursor controls (DIAL, +1/> and -1/<, ENTER, EXIT) and the ALPHANUMERIC keypad.

DIAL, +1/> and -1/<, ENTER, EXIT

DIAL

- Increases the value of the selected parameter continuously when rotated in a clockwise direction. When rotated in an anticlockwise direction, the value of the selected parameter is decreased continuously.

- In the main display, this control changes Performance (in “Performance” mode) or the Sound of the selected track (in “Sounds” mode) in a continuous manner. In the edit pages, it moves the reverse-highlight cursor from one parameter or menu item to another.

+1/> and -1/<

- +1/> increases the value of the selected parameter by one unit. -1/< decreases the value of the selected parameter by one unit.

- In the main display they change the Performance (in Performance mode) or Sound of the currently selected track (in Sounds mode) in single steps. In the edit pages they move the reverse-highlight cursor across the parameters or menu items.

These controls are equivalent to the DIAL, but increase or decrease existing data value by one unit at a time. The DIAL is best used to change existing data value by a significant amount.

ENTER

- Confirms the specified parameter value.
- In edit, it gains access to the modification of the parameter and confirms the value specified.

S2R: In the main display, when the instrument is set to Sounds mode, striking ENTER plays a note (Sound Test), permitting you to hear the Sound assigned to the currently selected track. The Sound Test also plays expanders connected to the S2R MIDI OUT.

EXIT

- Cancels the value that is about to be assigned to the selected parameter.
- With the “Are you sure?” window, it aborts the current edit operation.

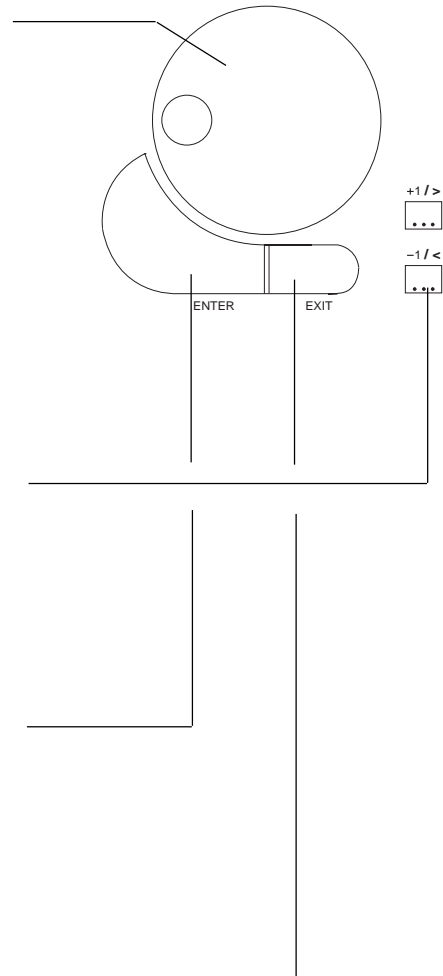

Alphanumeric keypad

The ALPHANUMERIC KEYPAD is used to specify numbers and letters.

How to specify numeric data

The numbers are silk-screened on the buttons. To specify positive values, simply press the relative number (n° + the symbol required). To specify a negative value, press the “-” button before entering the required number.

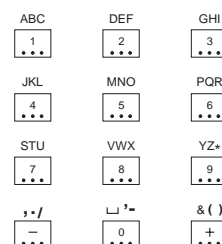

Numeric data is inserted in an edit zone which activates the instant you specify the first entry:



In some cases, the number specified requires confirmation with **ENTER**, in other instances, confirmation is not necessary. When Sounds are selected with the **NUMERIC KEYPAD** (Program Change), confirmation with **ENTER** is always required.

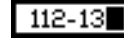

*Selection of the Sound 112-13. Confirm with **ENTER**.*

During the specification of a number, **EXIT** can cancel the entry.

The cursor can be moved in the edit zone with the **DIAL** or the **+1/>** and **-1/<** buttons to permit the correction of a wrong number:

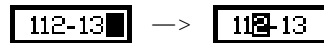

How to enter alphabetic characters

Each keypad button also recalls three letters of the alphabet. Simply press the button as many times as necessary until the required letter appears in the active zone of the display.

Navigating with the **DIAL**, **ENTER** and **EXIT**

The Data Entry controls are also used to navigate within the menus and to select the menu items and parameters.

The way in which these controls operate are equivalent to the “mouse” of a computer (now a very common computer accessory): the **DIAL** moves the reverse-highlight cursor, **ENTER** corresponds to the “click” on the mouse button to confirm a selection; **EXIT** corresponds to the Escape button.

Main Menus

- rotate the **DIAL** to select a voice (or editor);
- press **ENTER** to access a menu item and to open the corresponding secondary menu.



Edit Sound, main menu

Secondary menus (or lists of parameters)

- rotate the **DIAL** to selection an item (or parameter);
- press **ENTER** to place the parameter in edit:

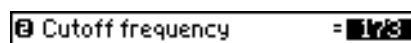

*Modify the value with the **DIAL**, or specify the new value on the numeric keypad.*

- press **ENTER** once (with a simple parameter) or several times (with a complex parameter) to confirm the value assigned to the parameter in edit;
- press **EXIT** to cancel the value assigned to the parameter in edit.

	EDIT SMD	12_ST_GTR	FILTER 1	PAGE: 1
↑/↓	1	Type	= Lowpass	Menu.....
2	Cutoff frequency	=	173	
3	Resonance	=	0	
4	Cutoff dynam. sens.	=	4	
5	Resonance dynam. sens.	=	0	
6	Cutoff touch sens.	=	0	
7	Out gain	=	0	compare...

Edit Sound, secondary menu (or editor) "Filter 1"

Use of the numeric keypad to navigate in the menus

In all menus, specify the number of the item or parameter that requires selection on the alphanumeric keypad. Access is instant.

«Emergency» buttons

These buttons provide a means of escaping from “locked” situations or to carry out a “quick check” of MIDI connections and sounds without effects, and they are available at all times.

PANIC

MIDI communications can sometimes “lock” the instrument due to the transmission of an excessive quantity of data, or by an incorrect message. The PANIC button sends “All notes off” and “Reset Controls” messages the internal sound generation and to all MIDI devices connected to the MIDI OUT, interrupting any locked notes and controllers.

MIDI OFF (S2/S3)

Activating this button (led on) deactivates the MIDI ports. *Warning:* Do not press this button while the S Series instrument is transmitting or receiving data; otherwise, the entire MIDI setup can lock.

EFF. BYPASS

The Sounds emitted by the LEFT and RIGHT* Audio Outputs is processed by the two DSPs (Effects processors - sounds are said to be emitted “wet”). If you want to use an external effects processor, or if you want to listen to your sound in its pure form (dry), press the EFF. BYPASS button to bypass the DSP.

When the DSPs are deactivated, the led on the button is on.

Reactivate the Effects to the Audio Outputs by repressing the button.

UNDO

In most parts of the edit environments, UNDO cancels the most recent operation, restoring the original status of the element in edit. UNDO also “undoes” itself: by pressing it a second time, it restores the cancelled situation: this is a useful way of comparing two different situations before making a final decision.

* The OUTPUTS 1, 2, 3, 4 always emit the sounds in their “pure” form (dry).

DISPLAY AND ASSOCIATED CONTROLS

The display is surrounded by controls which allow the user to navigate within the area - the display and associated controls is the principal means of communication between the user and machine.

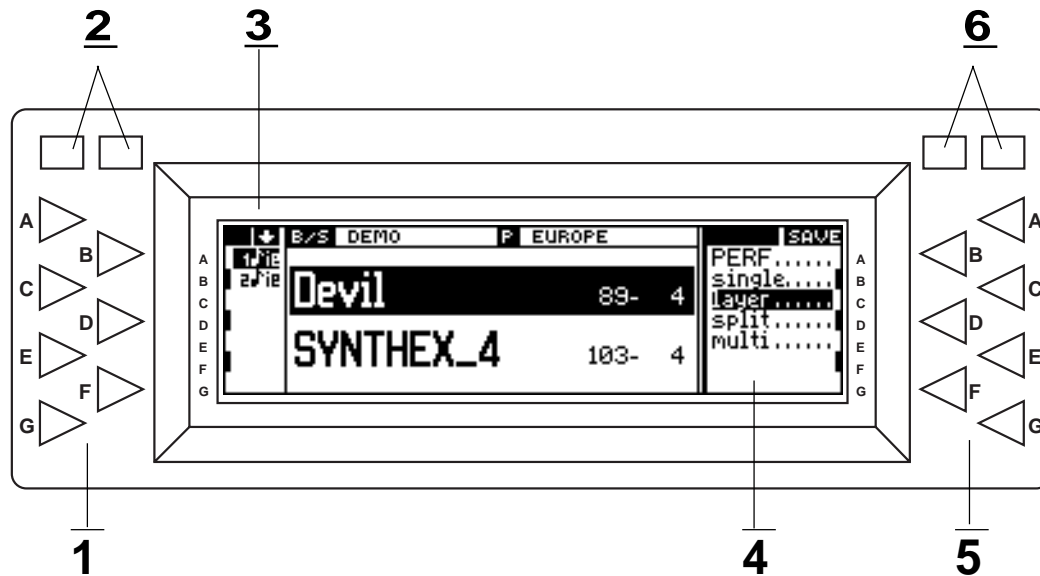

1. Track select keys

These select the corresponding tracks in the track column. If you press the relative key of a selected track, the track will be muted (x) or set back to play mode (♪).

2. Track scroll buttons

These bring the tracks not displayed into view. The track column can show a maximum of 7 of the 16 tracks of a Performance). If the buttons are held pressed, the tracks scroll continuously until released.

3. Track column

This column can show 7 of the 16 Performance tracks. The symbols shown next to the track number indicate the status of the currently active Source:

- ♪ shows that the track is active to play, or that it contains recorded notes (for the Song Source).
- x shows that the track is “mute”.
- shows that the track is disconnected from the LOCAL or MIDI IN Source, or that the track does not contain recorded notes (Song Source).
- i shows that the track is connected to the internal sound engine (GENERATION) If the symbol is not shown, the track cannot play the Sound.
- e shows that the track is communicating with MIDI OUT (if the symbol is not shown, the track cannot transmit MIDI).

A track is selected when it is shown in reverse-highlight.

When a track is played by a keyboard, a small symbol is flashed close the track number (as in a VU meter).

4. Command/Option column

Depending on the currently selected display, this column shows commands and options which can be selected with the Function Select keys (A -G).

The commands execute an action (ex. in the main menu, the command “Sounds” or “Perf” changes the Performance viewing mode). The options are mode selectors relating to commands or functions (ex. in the main display, in “Sounds” mode, the track playing options for the LOCAL Source *single*, *layer*, *split*, *multi*).

A selected option is shown in reverse-highlight.

5. Function select keys A-G

These select the corresponding commands/options shown in the display.

6. Multifunction buttons

These select the corresponding commands shown in the top right corner of the display. In the Edit pages, they normally select the next and previous pages. In the main display, the right button corresponds to the SAVE PERFORMANCE command.

MAIN DISPLAY / SAVE PERFORMANCE

The main display can be shown in two different viewing modes: “Performance” or “Sounds”. In the first mode, the Performance is displayed in large type, useful for rapid selection during a concert. In the second mode, the Sounds assigned to the tracks are shown, to allow complete control of the situation in Sound changing situations and Sound edit access.

“Performance” mode

The instrument powers up by default in “Performance” mode: in this situation the display shows the name of the current Bank/Song and Performance. The Performances can be scrolled with the DIAL, the +1/> and -1/< buttons or the ALPHANUMERIC KEYPAD*.

* The Performances are numbered from 1 to 10. '0' selects Performance 10

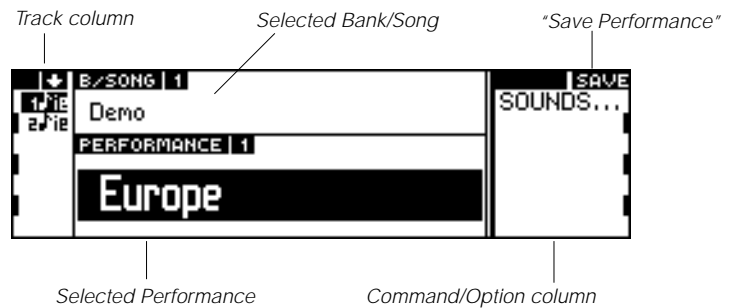

Select the SOUNDS command to pass to the “Sounds” mode.

“Sounds” mode

In this situation, the Sounds assigned to the tracks of the current Performance are displayed, as well as the track playing mode selectors (*single, layer, split, multi*). The track status is also shown which relates to the currently selected Source.

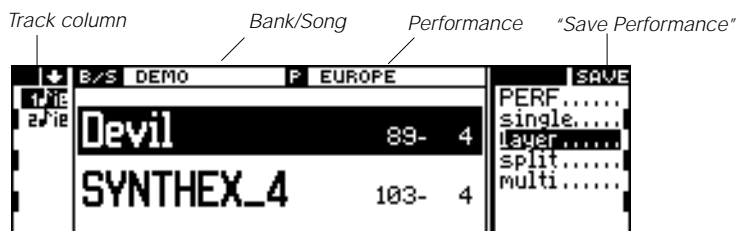

Track situation for the LOCAL Source (led LOCAL on)

Track situation for the MIDI IN Source (led MIDI IN on)

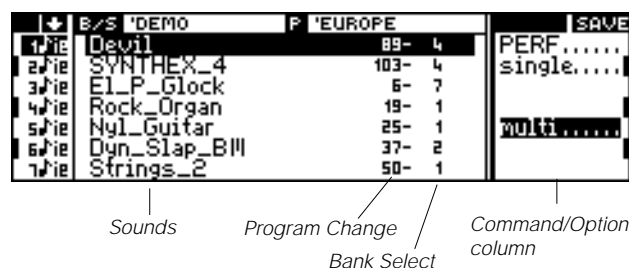

This operative mode allows the assignment of different Sounds to the tracks (*s. Sound selection further ahead*).

* The "Save Performance" command is disabled when the led on the "record" button is flashing (Song in record):



“Save Performance” (SAVE)

The main display shows the SAVE command, selected with the RIGHT MULTIFUNCTION BUTTON*. The command saves all modifications made to the Performance.

The modifications saved by the Performance: track playing mode (for LOCAL and MIDI IN), Sound assignments to the tracks, track status: “mute” (x) or “play” (♪), modifications made in EDIT PERFORMANCE/CONTROLS and in EDIT PERFORMANCE/TRACKS.

The status of the Function Controllers (active buttons and values inserted with the sliders) is also memorised in the Performance.

The Save Performance procedure in S2/S3 differs slightly to that in S2R.

“Save Performance” in S2/S3

1. Select the “Save Performance” command. A dialogue window is displayed which asks you to specify the Bank/Song and Performance where the memorisation is going to take place:



2. If you want to save the modifications in the current Performance, press ENTER twice. (Ignore the “Are you sure?” message, *s. further ahead*).
3. If you want to memorise the modifications to a different Performance of the same Bank, press the corresponding button in the Performance group and ENTER twice. This operation cancels all data in the selected Performance button.
4. If you want to memorise the modifications to a Performance of a different Bank/Song, press (a) a button in the Bank/Song group and (b) a button in the Performance group. Press ENTER twice to confirm. This operation cancels the data present in the selected Performance and creates a new Bank/Song if an empty one is selected.

“Save Performance” in S2R

1. Select the “Save Performance” command. A dialogue window is displayed which asks you to specify the Bank/Song and Performance where the memorisation is going to take place:

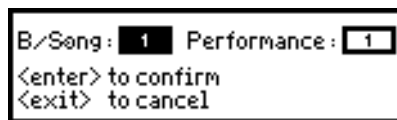

2. If you want to save the modifications in the current Performance, press ENTER twice.
3. If you want to memorise the modifications to a different Performance of the same Bank, (a) press ENTER, (b) indicate the number of the Performance with the DIAL or the NUMERIC KEYPAD, (c) confirm with ENTER.
4. If you want to memorise the modifications to a different Performance of a different Bank/Song, (a) indicate the number of the Bank/Song with the DIAL or NUMERIC KEYPAD, (b) press ENTER, (c) indicate the number of the Performance with the DIAL or NUMERIC KEYPAD, (d) press ENTER to confirm.

Note: The Performances saved will be irremediably lost when the instrument is turned off. To conserve your modified Performances, save the relative Bank/Songs to disk (*s. Practical guide, chapter: Save the contents of the Ram to disk*).

BANK/SONG AND PERFORMANCE SELECTION

Selecting the Bank/Songs and Performances in S2/S3

Selecting with the buttons of the Bank/Song and Performance sections

This method can be used regardless of the current operating mode of the instrument.

Leds indicate the currently selected Bank/Song and Performance.

1. Press the button corresponding to the Bank/Song to select.
2. Press the button corresponding to the Performance to select.

If the Performance belongs to the currently active Bank/Song, step 1 can be ignored.

Selecting in “Performance” mode

In the main display of the Performance mode, one of the 10 Performances of the currently active Bank/Song can be selected by rotating the DIAL, or by specifying the corresponding number on the ALPHANUMERIC KEYPAD (‘0’ corresponds to Performance 10).

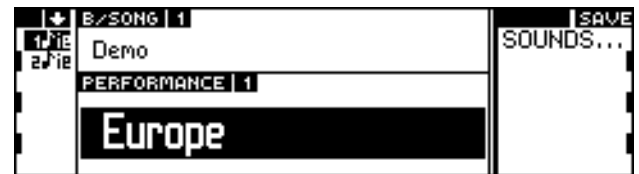

Selecting the Bank/Songs and Performances in S2R

Selecting in “Performance” mode

In the main display of the Performance mode, one of the 10 Performances of the currently active Bank/Song can be selected by rotating the DIAL, or by specifying the corresponding number on the ALPHANUMERIC KEYPAD (‘0’ corresponds to Performance 10).

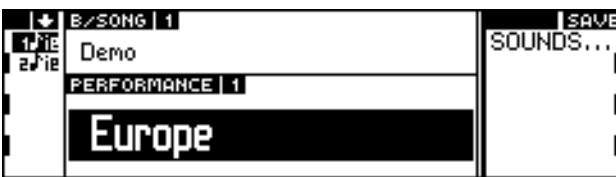

2. Specify the number corresponding to the Bank/Song. A list of the Performances contained in the selected Bank/Song is shown:



3. Specify the corresponding Performance number on the ALPHANUMERIC KEYPAD.

The Bank/Song and Performance selections in the dialogue windows can be performed using the DIAL and confirming with ENTER.

Selecting Bank/Song and Performances in “Sounds” mode

In “Sounds” mode, use is made of the B/SONG and PERFORM buttons.

1. Press the B/SONG button to display the list of Bank/Songs present in memory:



Selecting a Performance of the active Bank/Song in “Sounds” mode

1. Press the PERFORM button:



2. Specify the corresponding number of the Performance on the ALPHANUMERIC KEYPAD, or rotate the DIAL to select the Performance and press ENTER to confirm the selection.

SELECTING SOUNDS

If modifications have been made to the current Performance, selecting the same Performance, a different Performance, or one of the sequencer control buttons (RECORD, PLAY, STOP, <<, >>) will restore the original Performance. To conserve the newly assigned Sounds to the tracks, save the Performance to memory (s. Main display / Save Performance).

Selecting Sounds with the Dial (or the +1/> and -1/< buttons)

This method is used when the main display is showing “Sounds” mode.

The Sounds are arranged in a list which can be continuously scrolled forwards or in reverse order by rotating the DIAL.

- rotate to the right to scroll the Sounds forwards;
- rotate to the left to scroll the Sounds in reverse order.

The +1/> and -1/< buttons operate in the same manner as the DIAL but in single steps.

1. Select the track to which the Sound is to be assigned in the track column.
2. Select the Sound.

Selecting Sounds with the alphanumeric keypad

The method can be used when the main display is in “Sounds” mode.

The Sounds are identified by a Program Change number (1~128) and by a Bank Select number (1~16). The Program Change and Bank Select numbers found in the Sound Library are listed in the Appendix.

1. Specify the Program Change number.
2. Insert the separating “dash” (the *minus* ‘-’ symbol).
3. Specify the Bank Select number.
4. Confirm the selection with ENTER.

To select the Sounds with Bank Select=1 it is sufficient to specify only the Program Change number, without the Bank Select number.

For example, to recall Sound “Vibes2 [12-3]”, select the Program Change number 12 and the Bank Select number 3:

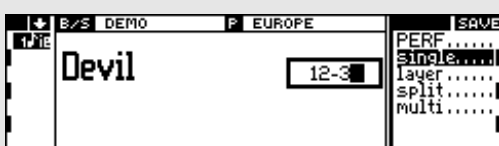

The selection is confirmed with ENTER:

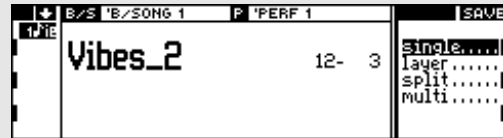

Selecting Sounds directly from the Sound Library

The Sounds are stored in the Sound Library, where they reside in order of Sound Family and identified by the Program Change and Bank Select numbers. The standard Sound Library is shown in the Appendix.

1. Access the Sound Library by pressing the SOUND LIBRARY button:

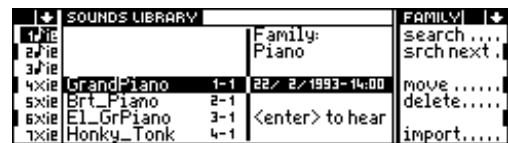

2. If necessary, select, in the track column, the track to which the Sound is going to be assigned.
3. Scroll to the Family of the Sound that you are looking for using the MULTIFUNCTION BUTTONS. For example, the “Guitar” Family:

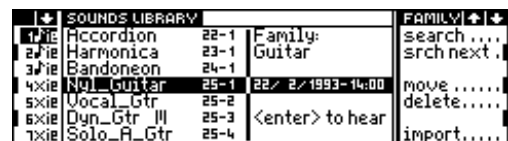

4. Rotate the DIAL to select the required Sound (rotate to the right to scroll forwards).
5. Press ENTER to assign the Sound to the selected track.
6. Escape from the Sound Library by pressing NORMAL or SOUND LIBRARY.

You can select the Sounds in the Sound Library by specifying the Program Change-dash-Bank Select combination on the alphanumeric keypad (as in the previous case).

CORRECT TRACK VISUALISATION

The tracks which appear in the main display differ according to the button selected in the Source section.

The instrument powers up with the LOCAL button selected by default. The LOCAL Source corresponds to the keyboard or the master keyboard connected via MIDI-COMMON. Therefore, the default display shows the tracks which can be played by the keyboard or by the master keyboard connected via MIDI-COMMON.

Visualisation of the tracks that can be played on a keyboard

The keyboard (S2/S3) or master keyboard connected via Midi-Common (S2R) generate LOCAL events. The LOCAL button must be selected in the Source section.

B/S DEMO		P EUROPE		SAVE
1	ie Devil	89-	4	PERF.....
2	ie SYNTHEX_4	103-	4	single.....
				layer.....
				split.....
				multi.....

Main display, Perf 1, LOCAL button selected

Symbols showing the status of the tracks: ♪ = track in play, x = track mute, i = the track is connected to the internal sound generator, e = the track is connected to the MIDI Out. If “i” does not appear, neither does the name of the Sound appear, it is substituted by a row of dashes (--- --).

Visualisation of the tracks that can be played via MIDI IN (not MIDI-COMMON)

The MIDI IN button must be selected in the Source section.

B/S DEMO		P EUROPE		SAVE
1	ie Devil	89-	4	PERF.....
2	ie SYNTHEX_4	103-	4	single.....
3	ie El_P_Glock	6-	7	
4	ie Rock_Organ	19-	1	
5	ie Nyl_Guitar	25-	1	multi.....
6	ie Dyn_Slap_BM	37-	2	
7	ie Strings_2	50-	1	

Main display, Perf 1, MIDI IN button selected.

Symbols showing the status of the tracks: ♪ = track in play, x = track mute, i = the track is connected to the internal sound generator, e = the track is connected to the MIDI Out. If “i” does not appear, neither does the name of the Sound appear, it is substituted by a row of dashes (--- --).

Visualisation of the tracks played by a Song

The SONG button must be selected in the Source section. This display setting is selected automatically when the SONG button is selected in the Edit group.

B/S DEMO		P EUROPE		SAVE
1	ie Devil	89-	4	PERF.....
2	ie SYNTHEX_4	103-	4	single.....
3	ie El_P_Glock	6-	7	
4	ie Rock_Organ	19-	1	
5	ie Nyl_Guitar	25-	1	multi.....
6	ie Dyn_Slap_BM	37-	2	
7	ie Strings_2	50-	1	

Main display, Perf 1, SONG button selected.

Symbols showing the status of the tracks: ♪ = the track contains recorded notes, - = the track does not contain recorded notes, x = track mute, i = the track is connected to the internal sound generator, e = the track is connected to the MIDI Out. If “i” does not appear, neither does the name of the Sound appear, it is substituted by a row of dashes (--- --).

TRACK PLAYING MODE

If modifications have been made to the current track playing mode, selecting the same Performance, a different Performance, or one of the sequencer control buttons (RECORD, PLAY, STOP, <<, >>) will restore the original track playing mode. To conserve track playing mode changes, save them to the required Performance (s. *Main display / Save Performance*).

The tracks of the Performance can be combined in different ways to provide several *track playing modes*. In “Sounds” mode, from two to four different track playing modes can be selected, depending on which Source is currently active. The track playing mode for the LOCAL and MIDI IN Source can be saved to the Performance.

The command buttons that select the various track playing modes are in the Command/Option column of the main display when it is set to “Sounds” mode.

Track playing modes available for each Source

LOCAL SOURCE	Single, layer, split, multi.
MIDI IN SOURCE	Single, multi.
SONG SOURCE	Single, multi.
OPTION SOURCE	Single, multi

Description of the track playing modes

Single



A single track. The displayed track plays across the entire keyboard extension. The other tracks can be selected one by one by scrolling with the TRACK SCROLL BUTTONS.



Layer (LOCAL only)

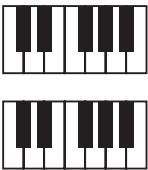

Activates two superimposed tracks which play across the entire keyboard extension. Other tracks can be selected by scrolling with the TRACK SCROLL BUTTONS.



Split (LOCAL only)



Activates two track that split the keyboard. The first track is assigned to the lower part, the second to the upper part. Other tracks can be selected by scrolling with the TRACK SCROLL BUTTONS. ✱



PLAY, MUTE, SOLO

The track status can be set to “play”, “mute” and “solo”.

The play and mute status can be memorised to the Performance.

Play

The play status is shown in the track column with the note symbol “♪”. To mute a track currently set in play, first select the track (if not already shown in reverse-highlight) and press the corresponding TRACK SELECTION KEY a second time.

Mute

The mute status is shown in the track column with the symbol “x”. To set a mute track in play, first select the

track (if not already shown in reverse-highlight) and press the corresponding TRACK SELECTION KEY a second time.

Solo

The Solo status isolates the selected track and silences all others.

Select the track that requires to be set to solo and press the SOLO button. The led on the button starts to flash.

If the selected track is currently set to mute, setting the solo status will activate the track for playing.

Press SOLO to deactivate the solo status. The led on the button stops flashing.

PRACTICAL GUIDE

PREPARE A WORK DISK WITH THE S SERIES DISK DRIVE

LOAD THE CONTENTS OF A DISK INTO RAM

- Load all
 - Load a Group
 - Load a Bank/Song
 - Load a Setup
-

SAVE THE CONTENTS OF RAM TO DISK

- Save all
 - Save a Group
 - Save a Bank/Song
 - Save a Setup
-

LOAD AND SAVE A SONG IN MIDI-FILE FORMAT

OVERVIEW OF THE DISKS SUPPLIED WITH THE INSTRUMENT

PLAYBACK A SONG / SEQUENCER CONTROLS / PRELOAD

CREATE OR MODIFY THE BANK/SONGS

EDITING THE PERFORMANCES

HOW TO RECORD A SONG

REAL TIME SOUND EDITING

- Using the Function Controllers
-

SOUND EDITING IN THE STUDIO

- Type of Sound
 - Waveform
 - Filters
 - Envelopes
 - Tracking
 - Lfo, Pitch, Pan
 - Memorising the Sound in the Sound Library and saving the SL
-

SELECTING SOUNDS VIA MIDI

SELECTING EFFECTS VIA MIDI

EDITING THE SOUND PARAMETERS VIA MIDI

PROGRAMMING WITH THE EXTERNAL SEQUENCER

- The "LOCAL OFF" Performance
-

1 PREPARE A WORK DISK WITH THE S SERIES DISK DRIVE

Before saving any data to a new floppy disk, you must format it (or initialize it) in order that the S Series instrument can recognise and use it.

The floppy disk should be a 3,5" HD type, in perfect condition.

1. Press the DISK button to gain access to the DISK operations.
2. Press the RIGHT MULTIFUNCTION BUTTON repeatedly until you reach the last page (Utility):



3. Specify number 1, corresponding to the "Format work disk (1.62 Mb)" operation.

A message appears inviting you to insert the floppy disk into the drive:



4. Insert the floppy into the drive and press ENTER to confirm. A dialogue window is displayed where you can insert a name to identify the disk. (This is not an obligatory operation - do it just the same).

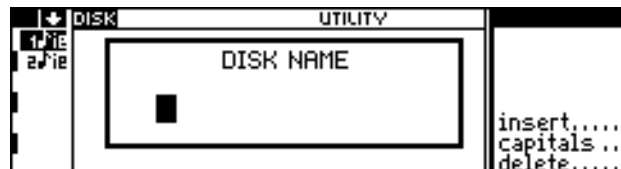

Insert the characters with the alphanumeric keypad.

Insert: inserts a space at the cursor position.

Capitals: allows the insertion of uppercase letters.

Delete: cancels an entry at the cursor position.

ENTER to confirm, EXIT to cancel.

5. Press ENTER to confirm (or EXIT to annul and interrupt the operation).

Warning: The formatting process destroys all data contained in a floppy disk. Use the Format operation only on new disks, or on disks that contain data that you are not interested in keeping.

2 LOAD THE CONTENTS OF A DISK INTO MEMORY

Load all the instrument's data from disk

It is possible to load, in a single operation, all the data required by the instrument to make it work. The data necessary is the following:

Setup	General, Sound Library, Effects Libraries, Clipboard.
GENERAL	General instrument settings (tuning, pedal assignments...).
SOUND LIBRARY	Ram-Sounds and modified Sound maps.
EFFECTS LIBRARIES	Effects maps assigned to the two DSPs.
CLIPBOARD	Edit page "Clips".
Bank/Song	Up to 10 Bank/Songs.

The Bank/Song consists of a Song and a Bank of 10 Performances. In the disk, the Bank/Songs are organised in 10 Groups of 10 Bank/Songs. In memory, only one Group (10 Bank/Song) can be loaded.

1. If you need to load data from floppy disk, insert the disk into the disk drive.
2. Press the DISK button to access the DISK HANDLING environment.
3. If a page other than the Load page appears, press the LEFT MULTIFUNCTION BUTTON REPEATEDLY (= previous Page) to go to the Load page:



4. Select the source element to load from (disk = FUNCTION SELECT A; RAM-disk = FUNCTION SELECT B):



5. Select the required Bank/Song Group, by pressing the corresponding FUNCTION SELECT KEY repeatedly until the number of the required Group appears next to the name of the selected element.
6. Specify number 1, corresponding to the "Load All" operation. You are asked for confirmation of the operation:

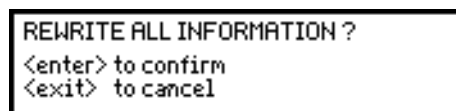

7. Press ENTER to confirm (or EXIT to cancel).

Load a Group of Bank/Songs

A disk can contain up to 10 Groups of 10 Bank/Songs each. It is possible to load only one Group (10 Bank/Songs) into the instrument's memory.

1. If you are loading from floppy disk, insert the disk into the disk drive.
2. Press the DISK button to access the DISK HANDLING environment.
3. If a page other than the Load page appears, press the LEFT MULTIFUNCTION BUTTON repeatedly (= previous page) to go to the Load page:



4. Select the source element to load from (disk = FUNCTION SELECT A; RAM-disk = FUNCTION SELECT B):



5. Select the required Bank/Song Group, by pressing the corresponding FUNCTION SELECT KEY repeatedly. If at least one Bank/Song is present on disk, the number of the relative Group will appear next to the name of the selected element.
6. Specify number 4, corresponding to the "Load all Bank/Song" operation. The instrument requests confirmation of the current operation:



7. Press ENTER to confirm (or EXIT to annul). The Songs and Performances contained in Ram are cancelled and substituted by the data loaded from disk.

Load a Single Bank/Song

A single Bank/Song consists of a Song and a Bank of 10 Performances (maximum). It is necessary to specify the source Group from which the Bank/Song will be loaded.

1. If you are loading from floppy disk, insert the disk into the disk drive.
2. Press the DISK button to access the DISK HANDLING environment.
3. If a page other than the Load page appears, press the LEFT MULTIFUNCTION BUTTON repeatedly (= previous page) to go to the Load page:



4. Select the source element to load from (disk = FUNCTION SELECT A; RAM-disk = FUNCTION SELECT B):



To navigate in the menus, you can (1) specify the number corresponding to the menu item, or (2) select the item with the DIAL and press ENTER to confirm the selection.
(S. "Overview of the instrument and its edit/data handling capacity").

- Select the required Bank/Song Group, by pressing the corresponding FUNCTION SELECT KEY repeatedly. If at least one Bank/Song is present on disk, the number of the relative Group will appear next to the name of the selected element.
- Specify number 5, corresponding to the "Load single Bank/Song" operation. The list of Bank/Songs present in disk contained in the selected Group appear in the display:

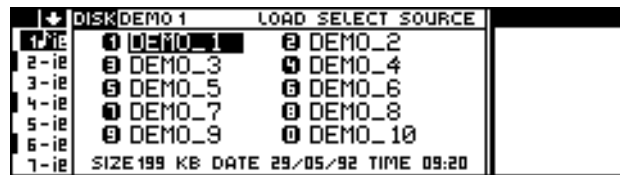

- Specify the number corresponding to the required Bank/Song to load ('0' corresponds to Bank/Song 10). The list of the 10 Bank/Song memory destination slots is displayed:

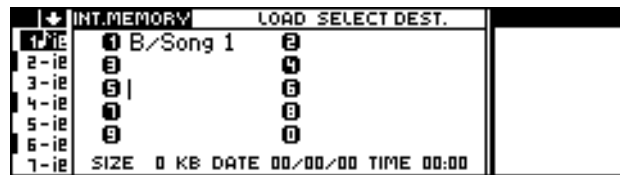

- Specify the number corresponding to the Bank/Song destination slot. If the selected location already contains a Bank/Song, this will be cancelled and substituted by the incoming Bank/Song.

The "Are you sure?" display is shown:

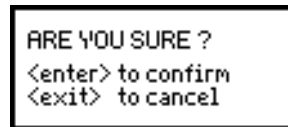

- Press ENTER to confirm (or EXIT to annul).

Load a Setup

There are four Setups: General, Sound Library, Effects Library, Clipboard. A disk can contain one Setup of each type (for ex.. a single Sound Library and a single General).

The most frequency loaded setup it the Sound Library.

- If you are loading from floppy disk, insert the disk into the disk drive.
- Press the DISK button to access the DISK HANDLING environment.
- If a page other than the Load page appears, press the LEFT MULTIFUNCTION BUTTON repeatedly (= previous page) to go to the Load page:

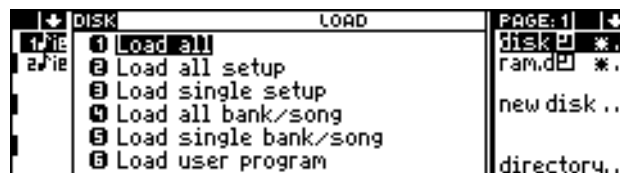

- Select the source element to load from (disk = FUNCTION SELECT A; RAM-disk = FUNCTION SELECT B):



- Specify number 3, corresponding to the “Load single Setup” operation. A list of the Setups contained in the disk appears:



- Specify the number corresponding to the required source Setup. “Are you sure?” is shown:

```

ARE YOU SURE ?
<enter> to confirm
<exit> to cancel

```

- Press ENTER to confirm (or EXIT to cancel). The incoming Setup cancels and substitutes the existing Setup in memory.

Warning: If you have modified some Sounds and have no desire to loose them, save the Sound Library to a new floppy disk, following the instructions explained in the next chapter. After saving the old Sound Library, load the new one to substitute the old.

The same warning is valid for the Effects Libraries and General Setups.

3 Save the contents of memory to disk

Save all the instrument's data to disk

It is possible to save, in a single operation, all the data required by the instrument to make it work. The data necessary is the following:

Setup	General, Sound Library, Effects Libraries, Clipboard.
GENERAL	General instrument settings (tuning, pedal assignments...).
SOUND LIBRARY	Ram-Sounds and modified Sound maps.
EFFECTS LIBRARIES	Effects maps assigned to the two DSPs.
CLIPBOARD	Edit page "Clips".
Bank/Song	Up to 10 Bank/Songs.

The Bank/Song consists of a Song and a Bank of 10 Performances. In the disk, the Bank/Songs are organised in 10 Groups of 10 Bank/Songs. When you save the Bank/Songs you must specify the Group to which the Bank/Songs will be saved.

1. If you are saving to floppy disk, insert a formatted disk into the disk drive.
2. Press the DISK button to access the DISK HANDLING environment.
3. If a page other than the Save page appears, press the LEFT OR RIGHT MULTIFUNCTION BUTTON REPEATEDLY to go to the Save page:

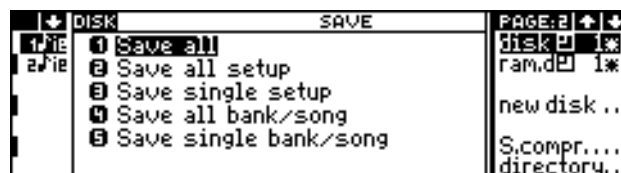

4. Select the destination element to save to (disk = FUNCTION SELECT A; RAM-disk = FUNCTION SELECT B)



5. Select the Group of Bank/Songs, to which the Bank/Songs contained in memory are going to be saved, by pressing the corresponding FUNCTION SELECT KEY repeatedly until the number of the required Group appears next to the name of the selected element. An asterisk (*) shows that the Group is empty; in this case, saving the Bank/Songs contained in memory does not destroy the Bank/Songs eventually present on disk.
6. Specify number 1 corresponding to the "Save All" operation. The instrument requests confirmation of the current operation:

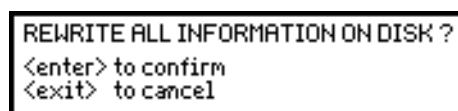

7. Press ENTER to confirm (or EXIT to cancel).

Save all the Bank/Songs in a Group

A disk can contain up to 10 Groups of 10 Bank/Song each. The 10 Bank/Songs contained in memory is saved to one of the Groups present on disk. The empty Groups are identified by an asterisk (*) after the Group number.

1. If you are saving to floppy disk, insert a formatted disk into the disk drive.
2. Press the DISK button to access the DISK HANDLING environment.
3. If a page other than the Save page appears, press the LEFT OR RIGHT MULTIFUNCTION BUTTON REPEATEDLY to go to the Save page:



4. Select the destination element to save to (disk = FUNCTION SELECT A; RAM-disk = FUNCTION SELECT B):



5. Select the Group where the Bank/Songs contained in memory are going to be saved by pressing the corresponding FUNCTION SELECT KEY repeatedly, until the number of the required Group appears next to the name of the selected element. An asterisk (*) shows a completely empty Group.
6. Specify number 4, corresponding to the “Save all Bank/Song” operation. The instrument requests confirmation of the current operation:



7. Press ENTER to confirm (or EXIT to annul). All Songs and Performances contained in the selected Group will be cancelled and substituted by the incoming data from memory.

Save a single Bank/Song

A single Bank/Song consists of a Song and a Bank of 10 Performances (maximum). The destination Group in the disk where the Bank/Song will be saved must be specified.

1. If you are saving to floppy disk, insert a formatted disk into the disk drive.
2. Press the DISK button to access the DISK HANDLING environment.
3. If a page other than the Save page appears, press the LEFT OR RIGHT MULTIFUNCTION BUTTON REPEATEDLY to go to the Save page:

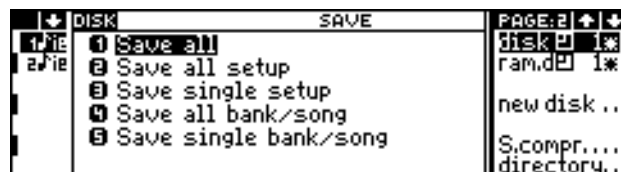

4. Select the destination element to save to (disk = FUNCTION SELECT A; RAM-disk = FUNCTION SELECT B):



- Select the destination Group where the Bank/Song is to be saved by pressing the corresponding FUNCTION SELECT KEY repeatedly, until the number of the required Group appears next to the name of the selected element. The asterisk (*) shows a completely empty Group.
- Specify number 5, corresponding to the “Save single Bank/Song” operation. A list of the Bank/Songs present in memory appears:



- Specify the number corresponding to the Bank/Song to save ('0' corresponds to Bank/Song 10). A list of the 10 Bank/Song slots contained in the destination Group is shown:

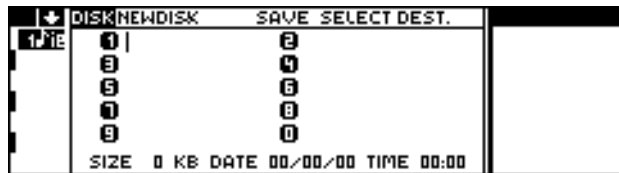

- Specify the number corresponding to the location where the Bank/Song is to be saved. If the location already contains a Bank/song, it will be cancelled and substituted by the incoming Bank/Song.

Confirmation with “Are you sure?” is requested:

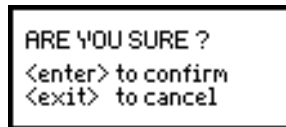

- Press ENTER to confirm (or EXIT to annul).

Save a single Setup

There are four Setups: General, Sound Library, Effects Library, Clipboard. A disk can contain one Setup of each type (ex. a single Sound Library and a single General).

The most frequently saved setup is the Sound Library.

- If you are saving to floppy disk, insert a formatted disk into the disk drive.
- Press the DISK button to access the DISK HANDLING environment.
- If a page other than the Save page appears, press the LEFT MULTIFUNCTION BUTTON REPEATEDLY (= previous Page) to go to the Save page:

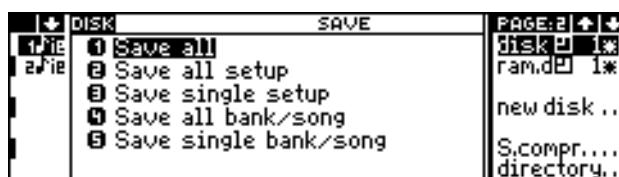

4. Select the destination element to save to (disk = FUNCTION SELECT A; RAM-disk = FUNCTION SELECT B):



5. Specify number 3, corresponding to the “Save single Setup” operation. A list of the Setups contained in memory is shown:



6. Specify the number corresponding to the Setup to save. Confirmation is requested with “Are you sure?”:

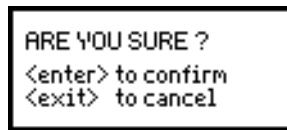

7. Press ENTER to confirm (or EXIT to annul). The saved Setup substitutes the Setup present on disk.

4 LOAD AND SAVE A MIDI-FILE

Memory format and MIDI-files

Each instrument equipped with a disk drive uses its own format for the disks and Songs. This format is not directly legible by other musical instruments. For example, an S Series instrument is not able to read a Song created and memorised to a disk by a WX Series instrument.

The S Series and many of the more recent instruments and sequencers can save Songs in a format called “Standard MIDI-file”* on Ms-Dos or Atari format disks.

* The S Series reads MIDI-files in format 0 (single track) and format 1 (multi-track); saves MIDI-files in format 1.

Compatibility of the sounds (MIDI-files in General Midi/GS standard)

When a musical instrument reads a MIDI-file created by a different musical instrument, it is highly probable that the song selects incorrect sounds. Most instrument, in fact, organise their sound maps in a non-standard manner.

General Midi (GM) and **GS** are standards adopted by most manufacturers, conceived to standardise the organisation of the sound maps in different musical instruments. For example, the S Series — which is compatible with General Midi and with GS — has a Sound Library organised in a manner similar to the sound maps of other General Midi/GS compatible instruments.

As well as the sound mappings, General Midi/GS also renders drumkits compatible. In General Midi/GS STANDARD MIDI-files, the drumkit is assigned to MIDI channel 10. (By default, in the Performances of the S Series, MIDI channel 10 is assigned to track 10).

General Midi Standardising regulations for sound maps to apply to different musical instruments.

GS An extension of the General Midi standard. Standardises the Program Change numbers of drumkits.

Midi channel 10 Reserved for the drumkits. In the S Series, Midi channel 10 is assigned to Track 10 of all the Performances by default.

Activation of the General Midi/GS compatibility

The default status of the S Series does not fully comply to General Midi: the program change numbers that recall the drumkits on MIDI channel 10 differ to those specified by the standard.

To render the S Series fully General Midi/GS compatible, it is necessary to activate the “General Midi” parameter (in EDIT GENERAL).

When the General Midi/GS compatibility is active (on), the exchange of MIDI-files (and MIDI communications) between the Music Processor and a General Midi/GS instrument is instant and does not require further adjustments. The correct drumkits will be recalled on Midi channel 10.

1. Press GENERAL in the Edit section to gain access to the EDIT GENERAL environment (the example shows a display relating to S2/S3. S2R differs slightly):

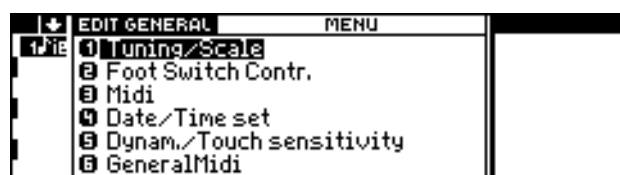

- Specify 6 to access the “General Midi” parameter:



- Specify 1 (or press ENTER) to place the “General Midi” parameter in edit:



- Specify 1 (or rotate the DIAL) to set the parameter to On:



- Press ENTER to confirm. Escape from the edit with NORMAL.
- If the new status is required in all situations, save the parameter status to the battery-backed memory* with the “Memorize” command (FUNCTION SELECTED KEY G).

* Memory which conserves user-programmed settings relating to Date & Time, Footswitch status, Sound Test programming (S2R), and General Midi status. (These parameters are programmed in EDIT GENERAL).

Load a MIDI-file

- Press the DISK button to gain access to the DISK environment and go to the Utility page:



- Select the “Load Midi standard file” operation. You are invited to insert an Atari/Ms-Dos disk containing the MIDI-file:

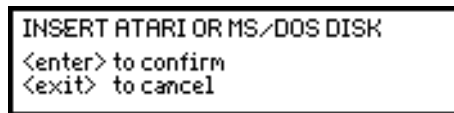

- Insert the floppy into the drive and press ENTER. The disk’s main directory is displayed where the MIDI-files contained in the disk are shown (files with the extension “.MID”):

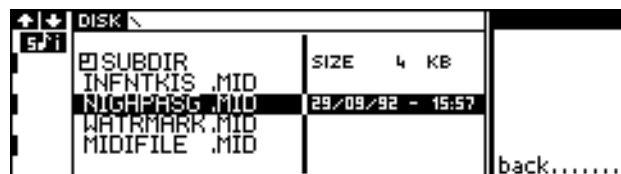

- Select the sub-directories (items identified by the symbol \square), which can contain other MIDI-files. To gain access to one of the sub-directories, select it and press ENTER. To return from the sub-directory to the main directory, select the “Back” command (FUNCTION SELECT G).

- Select the required MIDI-file and confirm. The list of the Bank/Songs contained in memory appears:



- Select a memory destination where the file will be loaded and confirm with ENTER. If you select an occupied location, the existing Bank/Song will be cancelled and substituted by the MIDI-file.
- The MIDI-file will be converted to an S Series standard Song. A new Bank will be created with only one Performance (1), with standard programmed values.
- Assign the correct Sounds to the tracks of the Performance and carry out all the operations necessary to optimise the converted Song (particularly the track transpose and track volume settings).

Save a MIDI-file

You'll need an Atari/Ms-Dos formatted floppy disk. If you don't have one on hand, you can initialise a disk to the required format using procedures 2 and 3 in the Disk Utility page. Consult the *Disk* chapter in the *Reference* section.

The more recent computers are able to make use of disks with a greater capacity (1.44 Mb - HD type disks). The 720 kb format is used by the Atari ST computer non fitted with the drive for HD floppies.

- Press the DISK button to gain access to the DISK environment and go to the Utility page:



- Select the "Save Midi standard file" operation. You are invited to insert an Atari/Ms-Dos disk containing the MIDI-file:

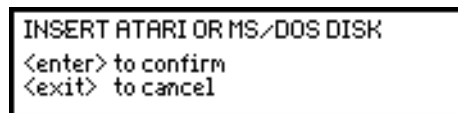

- Insert the floppy into the drive and press ENTER. The list of the Bank/Songs contained in memory is shown:



4. Select the Song to save as a MIDI-file and confirm. The disk's main directory is displayed where MIDI-files contained in the disk may be shown (files with the extension ".MID"):

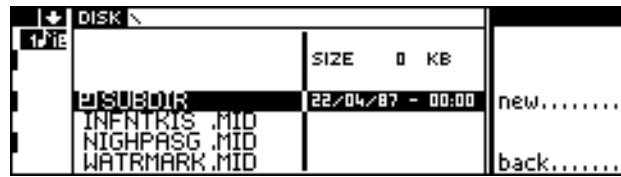

4. You can save the MIDI-file in a sub-directory (item identified by the symbol \square). To gain access to one of the sub-directories, select it and press ENTER. To return from the sub-directory to the main directory, select the "Back" command (FUNCTION SELECT G)
5. Select the "New" command to create the new MIDI-file. You will need to enter a name for the new MIDI-file:

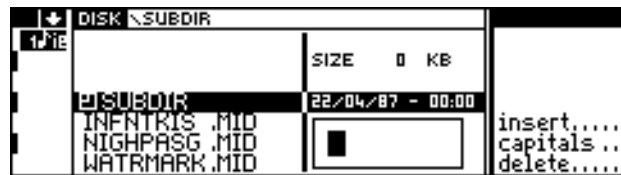

Insert the characters with the alphanumeric keypad.

Insert: inserts a space at the cursor position.

Capitals: allows the insertion of uppercase letters.

Delete: cancels an entry at the cursor position.

ENTER to confirm, EXIT to annul.

6. Press ENTER to confirm the name. The instrument requests confirmation of the save MIDI-file operation:



7. As an alternative to points 5 and 6 above: instead of selecting the "New" command, you can select an existing file and press ENTER. The previous file will be cancelled.
8. The Song will be converted to a Type 1 MIDI-file (multi-track MIDI-file). The Program Change numbers of the Performance will be inserted at the beginning of each track.

5 OVERVIEW OF THE DISKS SUPPLIED WITH THE INSTRUMENT

Your instrument is supplied with three floppy disks. The floppies “Demo Disk 01” and “Demo Disk 02” contain new Sounds, new Waveforms and some demonstration Songs. The floppy called “Freeware Disk” contains User Programs which implement some useful functions. By means of the “Directory” command, you can see what elements each disk contains. The “Directory” is none other than a list of the disk’s contents.

“Demo Disk 01”

This floppy disk contains 10 demonstration Songs and some Ram-Sounds based on new Waveforms.

The Bank/Song directory

1. With the instrument turned on, insert the floppy into the disk drive and press the DISK button to access the DISK environment:

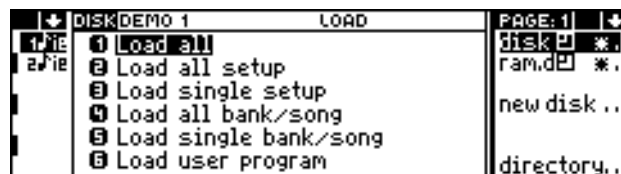

Disk, page 1 (Load)

2. Select (if necessary) the “Disk” option by pressing FUNCTION SELECT KEY A.
3. Select the “Load all bank/song” or “Load single bank/song” menu item with the DIAL:

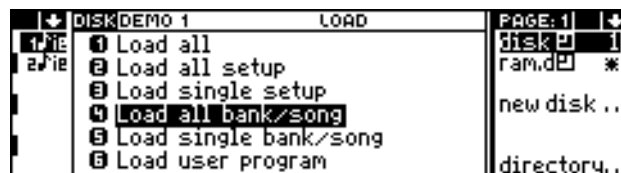

The “Load all Bank/Song” operation is selected.
The number (1) of the Bank/Song Group contained in the floppy is shown next to the “disk” option. The Demo Disk contains Group 1 only.
The asterisk (*) shows that the Ram-disk does not contain any Bank/Songs.

4. Select the “Directory” command with FUNCTION SELECT KEY G. The directory of the Bank/Songs contained in the disk is displayed:

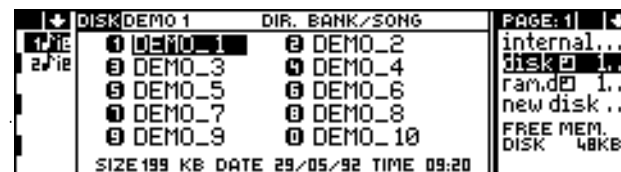

10 Bank/Songs are present. Rotate the DIAL to select one of the Bank/Songs shown and to obtain information on the dimensions (Size) of the file and the date of the last saved modification (Date).

The Performance directory

- It is also possible to see the Performances contained in each Bank/Song. Select the Bank/Song that you're interested in with the DIAL, then pass to page 2 with the RIGHT MULTIFUNCTIONBUTTON:



Directory of the Performances contained in a Bank/Song. You can return to the Bank/Song directory with the left multifunction button.

- Escape from the “Directory” with EXIT.

The Setup directory

Setups are data blocks which radically change the instrument’s general settings. A disk can contain four Setups (and four in memory):

- General:** general settings;
- Sound Library:** a Sound archive;
- Effects Libraries:** the Effects archives;
- Clipboard:** “clips” from various edit pages.

- With the instrument turned on, insert the floppy into the disk drive and press the DISK button to access the DISK environment:



Disk, page 1 (Load)

- Select (if necessary) the “Disk” option by pressing FUNCTION SELECT KEY A.
- Select “Load all setup” or “Load single setup” with the DIAL:



*“Load all Setup” is shown selected.
A Bank/Song Group number is not shown because the disk (and memory) can contain only one Setup of each type.*

- Select the “Directory” command with FUNCTION SELECT KEY G. The Setup directory of the disk is displayed:

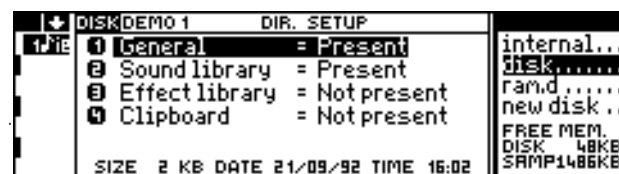

The General and Sound Library Setups are present. Rotate the DIAL to select one of the Setups and to obtain information on the dimensions (Size) of the file and the date of the last saved modification (Date).

6. Escape from the “Directory” with EXIT.

Check the RAM-Sounds contained in Demo Disk 01

1. Press the SOUND LIBRARY button to access the SOUND LIBRARY:

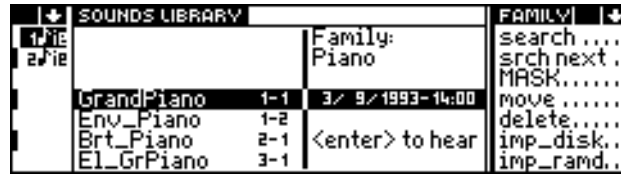

2. Select the “Imp_disk” (=import from floppy disk) command to display the RAM-Sounds contained in Demo Disk 01. While the internal Sound Library shows the ROM and Ram-Sounds, the Disk Sound Library shows only the RAM-Sounds:

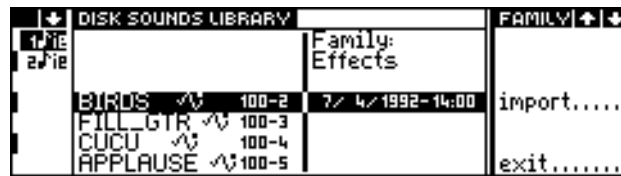

Ram-Sounds contained in Demo Disk 01. To scroll the Sounds, use the DIAL.
The MULTIFUNCTION BUTTON passes to the next or previous Family of Sounds.
The symbol shows that the Ram-Sound is based on a Waveform not contained in ROM.

3. Escape from the Disk Sound Library with EXIT, or select the “Exit” command with FUNCTION SELECT KEY G. Escape from the Sound Library with NORMAL or SOUND LIBRARY.

Load the Bank/Songs and Setups from Demo Disk 01

The loading procedures are described in this section, chapter “Load the contents of a disk into memory”, and in the “Disk” chapter of the *Reference* section.

* The same can be obtained by powering up with the disk inserted in the drive.

- It is possible to load all the data contained in the floppy disk using the “Load all”* procedure. This cancels all the data already present in memory.
- It is possible to load all the Bank/Songs contained in the Demo Disk using the “Load all bank/song” procedure. This cancels all the Bank/Songs already present in memory. The demonstration song present by default after powering up will be temporarily cancelled.
- It is possible to load a single Bank/Song, using the “Load single bank/song” procedure.
- It is possible to load all the Setups contained in the Demo Disk using the “Load all setup” procedure. This cancels the Setup already present in memory, causing the loss of all RAM-Sounds and new Effects**. The general settings can be modified by loading the General Setup, changing the following settings:

** It is not possible to load the Sound Library Setup if a Sound is currently in edit. It is not possible to load the Effects Libraries Setup if an Effect is currently in edit.

- the MIDI-COMMON status;
- the MIDI-Clock On/Off status;
- the footswitch assignments;
- the intonation scale (Scale).

- You can load a preferred Setup using the “Load single Setup” procedure. The Setup already present in memory will be modified.

“Demo Disk 02”

This disk contains a demonstration song (“Classic”) and a piano Sound (“Piano ”) based on a new Waveform.

You can load the contents of the disk using the “Load all” procedure.

If you are only interested in the new piano Sound, you can use the “Load single setup” procedure, selecting the Sound Library.

To load the new pianoforte without substituting the current Sound Library, you can use the “Imp_disk” command described below.

Load the new pianoforte from Demo Disk 02

1. Press the SOUND LIBRARY button to access the Sound Library:

SOUNDS LIBRARY		FAMILY
Family:	Piano	search
GrandPiano 1-1	3/ 9/1993-14:00	srch next .
Env_Piano 1-2		MASK.....
Brt_Piano 2-1	<enter> to hear	move
El_GrPiano 3-1		delete.....
		imp_disk..
		imp_rand..

2. Select the “Imp_disk” (= Import from RAM-disk) command to see the RAM-Sounds contained in Demo Disk 02:

DISK SOUNDS LIBRARY		FAMILY
Family:	Piano	
Gr_Piano2  1-3	6/12/1993-18:08	import.....
		exit.....

3. Given its large dimensions, the “Gr_Piano2 ” Sound is the only one present in the disk. It is already selected. Select the “Import” command to confirm the selection; the Sound Library is shown with free locations, (-- -- -- --):

SOUNDS LIBRARY		FAMILY
Family:	Piano	
GrandPiano 1-1		
Env_Piano 1-2		
----- 1-3		store.....
----- 1-4		name.....
----- 1-5	Gr_Piano2	
----- 1-6		exit.....

4. Select the “Store” command to load the Sound “Gr_Piano2 ” to the selected location.

The new Sound will be imported to the internal Sound Library and it can be assigned to a track using the standard procedure. You can save the updated Sound Library to a new floppy disk; this will save the Sound “Gr_Piano2 ” and relative Waveform.

“Freeware Disk”

This disk contains three User Programs which add new functions to the instrument’s operating system. You can load these programs (one at a time) using the “Load user program” procedure.

The “Hardcopy” program

Hardcopy allows you to capture and save any display image in “.IMG” format (Ventura Image) to a floppy disk (Ms-Dos format).

The “Disk_Dir” program

Disk Directory allows you to check the contents of a floppy disk, and to save the entire directory to a floppy (Ms-Dos format), including the list of the Bank/Songs, or the contents of the Libraries (Sound Library and Effects Libraries), storing them as text files (“.TXT”).

The “Copy_Prg” program

Copy Program can copy unprotected User Programs contained in a floppy disk (*source disk*) to another floppy disk (*target disk*). Some user Programs are protected by copyright and cannot be copied by “Copy Prg”.

6 SONG PLAYBACK / THE SEQUENCER CONTROLS

Load a Song using the standard procedure

Before playing back a Song contained in a disk you must load the relative Bank/Song. You can load a single Song (procedure [DISK] [LOAD SINGLE BANK/SONG]) or all ten Bank/Songs that can be stored in memory (procedure [DISK] [LOAD ALL BANK/SONG]).

The procedure is described in the section in chapter *Load the contents of a disk into memory*, and in the *Reference* guide, *Disk* chapter.

Use Preload to load a Song in background

Preload allows you to load a Song while another one is in playback. Together with the relative Bank/Song, the Sound Library and Effect Libraries Setups are loaded (if different from the ones currently residing in memory, and if the “Auto” option is selected).

Preload is a great time saver, particularly during a concert.

1. While a Song is in playback, press the PRELOAD button. The list of the Bank/Songs contained in the disk and the relative Group selected is displayed:

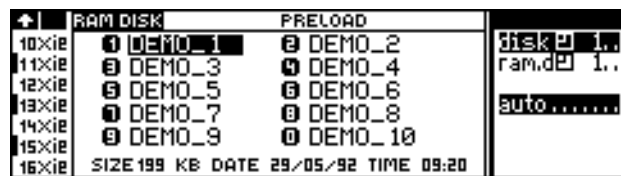

The “Auto” option must be selected (as shown).
If it is not selected, press the FUNCTION SELECT KEY D.

2. Select the source element to load from (disk = FUNCTION SELECT A; RAM-disk = FUNCTION SELECT B).
3. Select the required Group by repeatedly pressing the FUNCTION SELECT KEY corresponding to the selected disk option (A or B).
4. Specify the corresponding number of the Bank/Song to load on the ALPHANUMERIC KEYPAD.
5. The Bank/Song will be loaded in the first or second Bank/Song location according to the following rule:
 - in the first location (Bank/Song 1) by default;
 - in the second location (Bank/Song 2) if Bank/Song 1 is selected.

More information regarding Preload and the “Auto” option appears in the *Reference* section.

How to select the Song

Follow the standard procedure used to select a Bank/Song (*s. User Interface section*).

The Sequencer

Control the Song playback with the Sequencer controls:



RECORD Activates the Song "record" mode.

STOP Stops the Song playback or the recording.

PLAY Starts the playback (or the recording).

<< high velocity "rewind". Tapping on the button takes the Song back one bar at a time. Held pressed, it rewinds the Song at high speed.

>> Fast "forward". Tapping on the button advances the Song by one bar at a time. Held pressed, it advances the Song at high speed.

CLOCK Activates the Clock display which allows you to control the Tempo (metronomic) of the Song with the **DIAL**:



Escape this display with EXIT.

7 CREATE OR MODIFY THE BANK/SONGS

The 10 Bank/Songs of the Music Processor are already programmed to suit many “standard” playing situations. The Bank/Songs can, however, be modified to meet particular needs by changing the Performances, or by recording Songs.

The Song contained in a Bank/Song exploits the Performances of the same Bank/Song. A Performance should be programmed in relation to the sonic requirements of the Song that will be recorded later. The Performances provide Songs with changes of Sound assigned to the tracks, of Effects, of Panorama at the outputs and of the individual track volumes.

Cancel Song 1 (Demo)

A demonstration Song (Song 1 -Demo) is present in memory by default. If you want to liberate this location and conserve only the Performances of the Bank/Song, you must cancel the Song.

1. If necessary, select Bank/Song 1.
2. Press the SONG button in the Edit section to access the Playback display or the EDIT SONG environment.
3. If the Playback display appears, select the “Edit” command (with FUNCTION SELECT KEY B) to gain access to EDIT SONG:

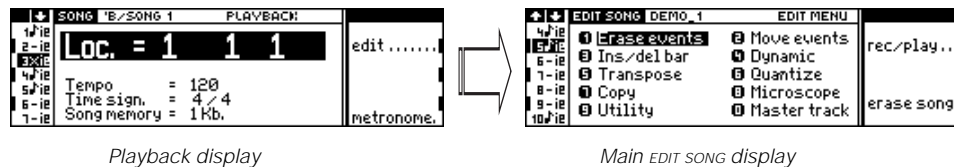

4. Select the “Erase Song” command. Confirm “Are you sure?” with ENTER to cancel the Song 1 (Demo).

Prepare a start-up disk to power up without Song 1 (Demo)

Even after having cancelled it, Song 1 (Demo) is always restored to memory each time the instrument is turned on (with the RAM-disk empty and no floppy disk inserted in the disk drive - default situation). This is because the Song is memorised in ROM, and cannot be permanently cancelled.

To impede the Song’s reappearance, you can prepare a “start-up” disk in the following manner:

1. Cancel the Demo Song using the method described above.
2. Press DISK to access DISK mode:



- Go to the second page (Save) with the MULTIFUNCTION BUTTONS:

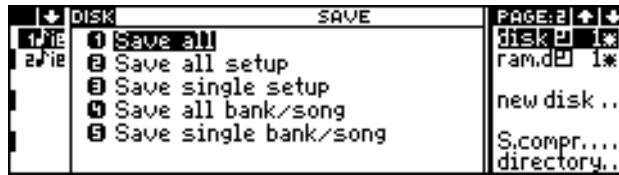

- Select the disk where you intend to save the start-up settings (FUNCTION SELECT A = floppy disk, FUNCTION SELECT B = RAM-disk).
- Specify 1 (or press ENTER) to save the entire contents of memory to disk.
- If the start-up disk chosen is the RAM-disk, turn on the instrument with no floppy disk inserted in the drive. The instrument will power up with settings contained in the Ram-disk (Bank/Song 1 with no Song).

If you want to override the Ram-disk when you turn on, in order to obtain standard default conditions, turn on the instrument holding the ENTER button pressed during the start-up - this will exclude the RAM-disk.

- If the start-up disk is the floppy, turn the instrument on with the floppy disk inserted in the drive. The instrument will power up with settings contained in the disk (Bank/Song 1 with no Song).

To restore default conditions, turn on the instrument with no disk inserted in the drive. (If the Ram-disk contains data, hold ENTER pressed during the start-up).

Record a new Song using the Performances of an existing Bank/Song

To record a new Song, you can use the Performances of an existing Bank/Song present in memory or one saved to disk.

- Select the Bank/Song and record a Song using the relative Performances. If necessary, you can cancel the Song already present in the Bank.
- You can load a Bank/Song from disk and use it to record your Song. If the Bank/Song already contains a Song, you can cancel it.

Using a Bank/Song already present in memory

- Select the Bank/Song.
- If necessary, cancel the existing Song.

Warning: Conserve a copy of the original Bank/Song in a disk, if you do not want to loose the original Song.

- Record the Song, following the procedure described in this section under the title *How to record a Song*.

Using a Bank/Song contained in a disk

- Load the Bank/Song from disk using the procedure [DISK] [LOAD SINGLE BANK/SONG] described in this section under the title *Loading the contents of disk to memory*.
- Record the Song, following the procedure described in this section under the title *How to record a Song*.

Create a new Bank/Song

You can create a new Bank/Song in two ways: (a) create a completely new Bank/Song, or (b) modify an existing Bank/Song.

You can then save the new Bank/Song to disk, for future use.

Cancel one of the 10 default Bank/Songs present in memory

1. Select the Bank/Song that you wish to cancel.
2. Press the UTILITY button to access the UTILITY data handling environment:



3. Specify 3 (or select “Delete Bank/Song” and press ENTER) to cancel the selected Bank/Song.
4. Confirm “Are you sure?” with ENTER.

Create a completely new Bank/Song

1. If necessary, cancel one of the Bank/Songs present in memory.
2. In the main display, select the “Save Performance” command.
3. Select an empty Bank/Song and the slot where you want to save the Performance.
4. Confirm the selection of the Bank/Song and Performance. A new Bank/Song will be created.
5. Use the “Save Performance” command of the main display to create the other Performances of the new Bank/Song.

Copy the same Performance in all the required locations of the new Bank/Song and then modify each Performance as required.

6. Or, use the “Copy Performance” function in the UTILITY environment.

Copy the Performances of other Bank/Songs into the empty slots of the new Bank/Song. (S. the Reference guide under the title: Utility).

8 EDITING THE PERFORMANCES

This chapter takes a look at Performance editing, allowing the creation of a completely new Performance by modifying an existing one. Although the 100 Performances residing in Rom may cover a wide range of musical tastes, it is often necessary to create a completely new set of Performances that adapt themselves to a particular situation or personal need.

The main display is where you can assign the Sounds to the tracks, select the various track playing modes for each Source and set them in “play” or in “mute” for each Source.

Other parameters of the selected Performance are edited in the EDIT PERFORMANCE/CONTROLS and EDIT PERFORMANCE/TRACKS environments.

Create, copy and cancel the tracks

The Performance can consist of any number of tracks from 1 to 16, giving a maximum of 16 different Sounds that can play simultaneously.

It is possible to cancel some tracks, or create new ones with default parameters.

How to cancel tracks

1. Access the EDIT PERFORMANCE/TRACKS environment by pressing the PERF. TRACKS button in the Edit section:

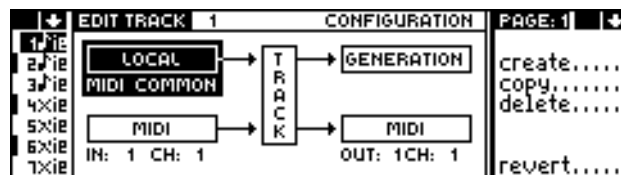

Edit Performance/Tracks, page 1

2. Select the track you wish to cancel with the corresponding TRACK SELECTION KEY. Scroll to the tracks out of view with the TRACK SCROLL BUTTONS.
3. Select “Delete” and confirm the cancellation of the track.

How to create tracks

1. Access the EDIT PERFORMANCE/TRACKS environment by pressing the PERF. TRACKS button in the Edit section: (s. display above).
2. If you want to substitute an existing track with a new one that has default parameters, select the track to substitute.
3. Select “Create”. A selection window opens where you can select the track to create:

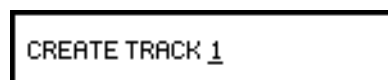

4. If necessary, specify the number of the track to create with the DIAL or the NUMERIC KEYPAD and confirm the operation.

Copy a track to another

1. Access the EDIT PERFORMANCE/TRACKS environment by pressing the PERF. TRACKS button in the Edit section: (s. display above).
2. Select the track to copy.
3. Select "Copy". A selection window opens where you can select the destination track:

COPY FROM THIS TRACK TO 1

4. Specify the destination track with the DIAL or the NUMERIC KEYPAD and confirm the copy operation.

How to assign the Sounds to the tracks

In order to be able to assign a sound to a track, the track must be selected. Use the TRACK SELECT KEYS and the TRACK SCROLL BUTTONS.

Select the Sounds from the main display

There are two ways to assign a Sound to a track directly from the main display (in "Sounds" mode):

- a) rotate the DIAL until you reach the required Sound - this control allows continuous selection (use the +1/> and -1/< buttons to select sounds one at a time).
- b) specify the Program Change-Bank Select numbers of the Sound on the NUMERIC KEYPAD, and confirm with ENTER. (ENTER is essential to transmit the specified Program Change data).

The Program Change and Bank Select combination must be specified in the following order: (1) specify the Program Change number, (2) insert the separating hyphen "-", (3) specify the Bank Select number. If the Bank Select = 1, it is sufficient to specify only the Program Change.

The ROM-Sound Program Change-Bank Select numbers are listed in the Sound table in the Appendix.

Select the Sounds from the Sound Library

1. Open the Sound Library by pressing the SOUND LIBRARY button:

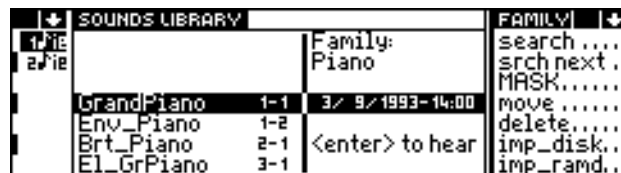

2. Go to the Sound Family* to which the required Sound belongs with the MULTIFUNCTION BUTTONS. For example, *Violin 41-1* belongs to the Strings Family.
3. Rotate the DIAL to select the required Sound.
4. Press ENTER to assign the selected Sound to the currently selected track.
5. Without escaping the Sound Library, select other tracks and assign them the Sounds as required using the method described.

* The Sounds of the S Series are organized in the Sound Library in "Families": sound groups that show marked similarities with others. The Families follow the order according to specifications stipulated by General Midi:

- PIANO
- CHROMATIC PERCUSSION
- ORGAN
- GIUITAR
- BASS
- STRINGS
- ENSEMBLE
- BRASS
- REEDS
- PIPES
- SYNTH LEAD
- SYNTH PAD
- EFFECTS
- ETHNIC
- PERCUSSIVE
- DRUMKITS.

Set the tracks to Play or Mute

The tracks of a Performance can be set to “play” or can be temporarily deactivated - “mute”. The “play” and “mute” track situations are related to the currently selected Source. Each Source will require separate track “play/mute” settings.

For example, track 1 can be set to “play” status for the **LOCAL** Source and to “mute” status for the **MIDI IN** Source.

The symbol that indicates “play” status active for all the Sources is “♪”, “mute” is “X”.

1. Select a track (if not selected) with the relative TRACK SELECT KEY.
2. Press the relative TRACK SELECT KEY again to alter the track status.

Track volumes

There are two ways to change the track volumes:

- a) by means of the Function Controllers;
- b) in EDIT PERFORMANCE/TRACKS, page 2.

How to vary the track Volumes with the Function Controllers

In the S Series keyboard models, check that the USER/PANEL button is not inserted (led off), then select the VOLUME button. Modify the volumes of the displayed tracks by moving the relative Function Controller sliders. Each slider (A-F) corresponds to a track identified by the same letters (A-F).

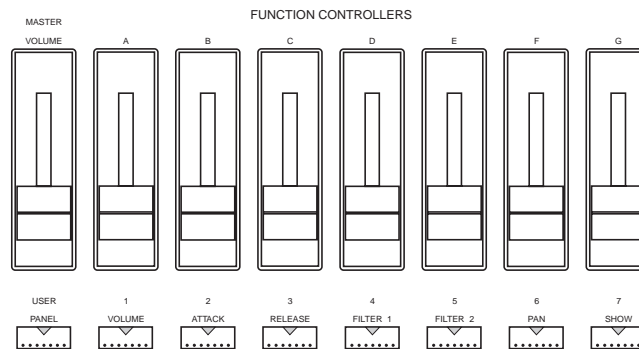

In S2R, access page 3 of EDIT PERFORMANCE/CONTROLS:



Select the “Volume” parameter, then select a track and rotate the DIAL to modify its volume level. Select other tracks and repeat the operation.

How to vary the Volumes in EDIT PERFORMANCE/TRACKS

Access EDIT PERFORMANCE/TRACKS by pressing the PERF. TRACKS button in the Edit section, and go to the second page:

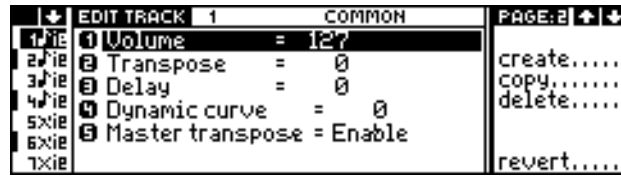

Edit Performance/Tracks, page 2:

1. Select the Volume parameter and enter into the edit of the parameter.
2. Select the first track to modify and specify the volume level required with the DIAL or the NUMERIC KEYPAD.
3. With the parameter still in edit, select other tracks and repeat the procedure.
4. Press ENTER to escape from the edit of the parameter.

Transpose

There are two ways of changing the track transposition settings:

- a) in the TRACK TRANSPOSER;
- b) in EDIT PERFORMANCE/TRACKS, page 2.

The transposition is always expressed in semitones.

How to vary the track transposition in the TRACK TRANSPOSER

1. Press the TRACK TRANSPOSER button:



2. Select the required track and rotate the DIAL, or specify the numeric value of the transposition with the NUMERIC KEYPAD. The “Octave up” and “Octave down” commands respectively increase or decrease the current pitch by one octave above or below the current setting.
3. The “Reset” command restores the Transpose settings of all the tracks to zero (standard pitch setting).
4. The “Master” command gains access to the Master Transposer, where you can vary the pitch of the instrument as a whole:

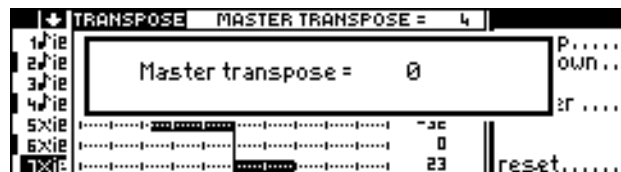

Modify the Master Transpose setting with the DIAL or the NUMERIC KEYPAD and confirm with ENTER to return to the TRACK TRANSPOSER display.

How to vary the track transposition in EDIT PERFORMANCE/TRACKS

Access EDIT PERFORMANCE/TRACKS by pressing the PERF. TRACKS button in the Edit section, and go to the second page:

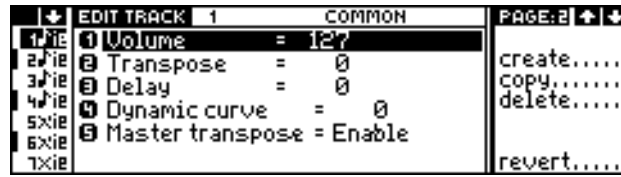

Edit Performance/Tracks, page 2

1. Activate the edit of the Transpose parameter.
2. Select the first track to modify and enter the required transposition with the DIAL or the NUMERIC KEYPAD.
3. With the parameter still in edit, select other tracks and repeat the procedure.
4. Press ENTER to escape from the edit of the parameter.

Effects

The Sounds of the S Series can be directed to two effects processors (Effect 1 & Effect 2), which generate reverberations and modulations. The Effects are stored in the two Effects Libraries (Effect 1 = reverbs, Effect 2 = modulations).

Each Performance can recall one effect from each processor (a reverb from Effect 1 and a modulation from Effect 2). The Effects are assigned to the Performance in the first page of EDIT PERFORMANCE/CONTROLS:

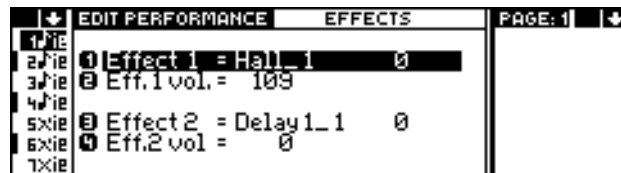

Edit Performance/Controls, page1

Each track can be individually programmed to play with or without the Effects assigned to the Performance - these tasks are carried out in page four of EDIT PERFORMANCE/TRACKS:

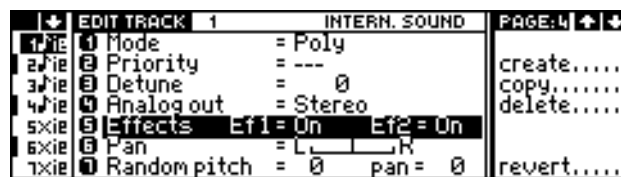

Edit Performance/Controls, page 4

How to assign the Effects to a Performance

1. Access the first page of EDIT PERFORMANCE/CONTROLS, and select the required Effects. There are two ways to select an Effect:
 - a) activate the edit of the parameter and rotate the DIAL, or specify the number of the effect with the NUMERIC KEYPAD.

b) open the Effects Libraries by means of the EFFECTS LIBRARIES button:

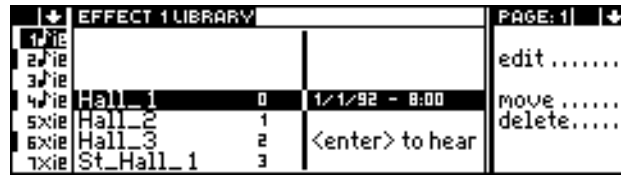

Select one of the Effects with the DIAL or NUMERIC KEYPAD. Press ENTER to assign the Effect to the Performance. Repeat the operation for the second Effects Library. Return to EDIT PERFORMANCE/CONTROLS by pressing PERF. CONTR.

2. Regulate the volume of each Effect. When the Effect volume is at its maximum value (127), the Sound emitted by the Stereo output pair is a “mixture” of 50% “wet” and 50% “dry”.

How to engage the Effects to the tracks

1. Go to page four of EDIT PERFORMANCE/TRACKS, and activate the edit of the Effects multiple parameter.
2. Select the first track to modify and engage (on) or disengage (---) Ef1 and/or Ef2 by rotating the DIAL. Pass from Ef1 to Ef2 and vice-versa by pressing ENTER repeatedly.
3. Select another track and repeat the procedure.

How to activate and programme the pedals and wheels

S2 and S3 have two rear panel programmable PEDAL/FOOTSWITCH SOCKETS (1 and 2) which can receive “pedal” type physical controllers and “footswitch” type physical controllers.

Pedals are “continuous controllers” (or *analog*) and are normally used to control Volume, Pan, Expression etc. Footswitches are “switch action” pedals (or *logic*), normally used to control Damper/Sustain, Start/Stop, etc.. The Footswitch Polarity can also be programmed in EDIT GENERAL.

S2R has two programmable “footswitch” sockets.

The keyboard models are also equipped with two programmable wheels, generally used to control Pitch Bend and Modulation.

How to assign a function to a pedal and wheel

1. Access page 2 of EDIT PERFORMANCE/CONTROLS:

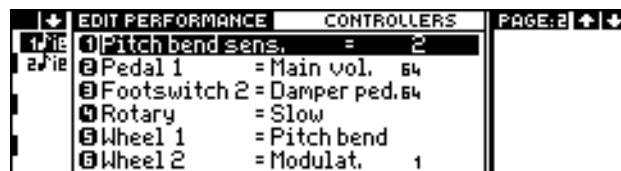

Edit Performance/Controls, page 2 (S2/S3)

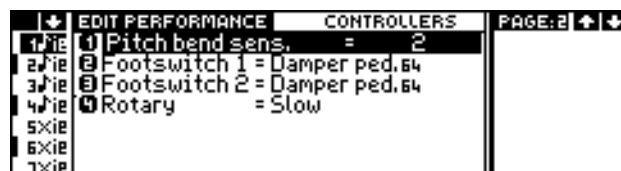

Edit Performance/Controls, page 2 (S2R)

2. Activate the “Wheel”, “Pedal” or “Footswitch” parameters. In the keyboard models, the first part of the multiple parameter can determine which Pedal/Footswitch input will receive one or the other type of Foot controllers:

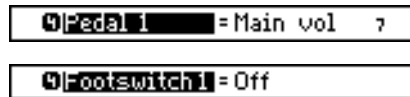

3. Select the second part of the parameter, which represents the MIDI message generated by the pedal/footswitch or by the wheel:

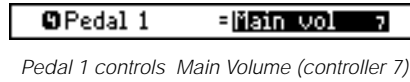

Pedal 1 controls Main Volume (controller 7)

The MIDI message assignable to the pedals and footswitches differ owing to the different nature of the two controllers. The assignment of a specific MIDI message depends on the nature of the pedal selected. The Reference section lists the messages assignable to each controller.

How to activate/deactivate the pedals and wheels for the tracks

1. Access page 3 of EDIT PERFORMANCE/TRACKS:

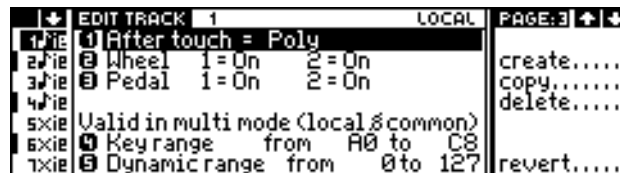

Edit Performance/Tracks, page 3 (S2/S3)

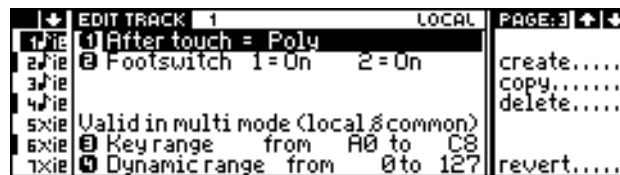

Edit Performance/Tracks, page 3 (S2R)

2. Select the track that you are interested in editing.
3. Set the selected controller (wheel, pedal, footswitch) to “On” or “---” (Off).

Save the modifications to the Performance

The modifications made to the current Performance must be saved to avoid losing them when you select another Performance or re-select the same Performance.

Select the **Save Performance** command in the main display and confirm the procedure with ENTER. You can memorise the modifications to the current Performance, to another Performance of the same Bank/Song, or of a different Bank/Song.

If you select a different Performance, bear in mind that the Performance that will be replaced will be irremediably lost.

Furthermore, for future use, save the updated Bank/Song to floppy disk or to RAM-disk; remember that turning off the instrument will result in the loss of the modified Performance.

9 HOW TO RECORD A SONG

What is a Song?

A Song is a recorded musical piece made up of several instrumental “parts”. Each Bank/Song consists of a Song (or an empty slot where a Song can be recorded) which exploits the Performances of the Bank/Song to which it belongs.

The playback and recording of the Song is controlled by the Music Processor’s on-board Sequencer. It is possible to record a Song, or load it from disk in the form of a Bank/Song or a MIDI-file.

A Song can be saved to floppy disk (as a Bank/Song) for the purpose of building a library of Songs and exchange with other S Series instruments. It is possible to save a Song in Standard MIDI-file format in order to play it on other equipment, regardless of the manufacturer.

Finally, it is possible to carry out multi-track recordings via MIDI, and the Song can play external musical instruments connected to the Music Processor’s MIDI OUT.

The Song tracks

Each part of a Song corresponds to one of the Tracks of a Performance. A Performance is always selected when you enter Song mode and, during the course of the Song playback or recording, you can select other Performances in order to modify the status and configuration of the tracks. A Song can utilise all the Performances of the Bank/Song to which it belongs.

To visualise the status of the tracks engaged by the Song, press the SONG button in the Source section (led on).

The status of each track of the Song is identified by the following symbols shown in the track column:

♪ The track contains recorded notes.

– The track is completely empty.

x The track is set to “mute”.

Prepare the tracks for the recording

A Song records the data generated by the LOCAL Source (keyboard or master keyboard via MIDI-COMMON) and the MIDI IN Source (instruments connected to the MIDI IN not via MIDI-COMMON). It is important, therefore, to set one or both Sources correctly before you start to record your Song:

LOCAL the status of this Source determines the number of tracks that can be recorded in the Song among those activated for recording. For example, if you activate 6 tracks in Record mode with the local Source set to *layer*, the Song will record two layered tracks that have the lowest numbers among the six tracks activated in Record. It is of no importance if the local tracks are set to mute (“x” symbol).

MIDI IN if you are recording data generated by the Midi In Source, the Sequencer will only record tracks activated to receive Midi In events (shown with the symbol “♪”), provided that they are also activated for recording. If the Midi In Source is set to *single*, the Sequencer will record only one track of Midi In events, regardless of how many tracks are activated for recording.

Configure the LOCAL and MIDI IN Sources. Select the required playing mode for the LOCAL Source. For the MIDI IN Source, select *multi* and activate the tracks for the reception of Midi In events (symbol “♪” in the track column).

After configuring the Sources, save the modifications in the current Performance with the “Save Performance” command in the main display ([SAVE] [ENTER] [ENTER]). If you omit this important step, activating Record mode recalls the original settings of the Performance, cancelling the newly configured status.

Activate Record mode and select the recording options

1. Press the RECORD button to access Record mode. A dialogue window appears, above the “record pending” display, which invites you to select the tracks and the recording options shown in the command/options column:

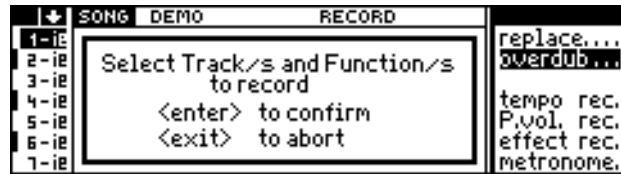

“Record pending” display: partially covered by a dialogue window. This is an S2/S3 display. In S2R “P.vol.rec” is substituted by “C.vol.rec”.

2. Select the tracks to record with the respective TRACK SELECTION KEYS. Use the TRACK SCROLL BUTTONS to bring other tracks into view.

Tracks activated for recording are identified with the symbol “R” in the track column. You can deactivate the tracks in record by repressing the respective TRACK SELECT KEY.

Attention: If you record from the keyboard or from a master keyboard via MIDI-COMMON, the number of tracks recorded will be equal to the number that appear in the LOCAL Source. The tracks having the lowest numbers will be recorded among those selected in Record. All other tracks will be ignored and, at the end of the recording, they will be identified by the hyphen (“-”), which indicates an empty track.

3. If necessary, select the options which appear in the command/options column:
 - if you want to record the Tempo changes effected from the control panel during the course of the recording, activate the “Tempo rec” option.
 - if you want to record the regulations of the general volume effected with the S2/S3 Volume Pedal, activate the “P. vol. rec” option. S2R can record Pedal Volume events travelling on MIDI-COMMON and not originating from the pedal connected to the rear panel pedal volume socket; the option is called “C.vol. rec”.
 - if you want to record the changes made to the Effects and Effect Volumes using the Function Controllers (in USER mode), or by means of MIDI messages, activate the “Effect rec” option.
 - if you want to listen to the metronome “tick” during the recording, activate the “Metronome” option.
4. Select the required recording option (“Overdub” to add new notes to those already present, or “Replace” to replace notes already recorded with new ones in the tracks shown with the “R” symbol).

Once you have set all the required recording options, press ENTER to confirm the settings (or EXIT to cancel and escape Record mode):

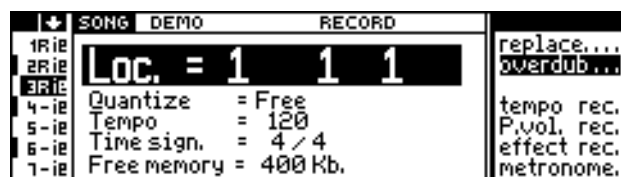

You can, however, select the options after confirming the track selections with ENTER. (The metronome can be freely activated and deactivated during the recording). Therefore, if you set one or more of the options incorrectly, confirm with ENTER then correct the error before starting the recording.

Select the parameters of the Song

Rotate the DIAL to select one of the displayed parameters in the central part of the “Record pending” display, and press ENTER to activate the edit of the selected parameter.

5. Select the required Quantize (auto-correct) value. “Free” will record your events exactly as played; other values represent the number of “divisions” that make up a bar. The Quantize effect is not noticeable during the recording but it is effective on recorded tracks.
6. Set a suitable Tempo value (playing speed) for the Song.
7. Set the required Time Signature (3/4, 4/4, etc.).

The Song pointer (locator)

The recording starts at the bar indicated by the “Locator” parameter (“Loc”, at the centre of the display shown on the previous page). This parameter (otherwise known as the “Song pointer”), composed of three numbers, shows the bar, the beat and the beat resolution*. In the record pending display, only the bar can be modified, and, unless you start a recording right at the beginning (1 - 1 - 1), the start bar must always be indicated.

* The beat resolution is the smallest impulse of the Sequencer. In the S Series, there are 192 ‘ticks’ per quarter. In Midi, there are 24 impulses per quarter.

You are free to end your recording at any point: press STOP to stop the recording process. For a precise end-record point, you can make use of the “Edit stop to bar” parameter in EDIT SONG—Utility. Follow this procedure:

8. If the RECORD led is on, press the record button to escape the Record pending display and return to the Playback display. (This operation annuls some of the options selected in Record).
9. Select the “Edit” command in the Playback display. The EDIT SONG menu appears (or the last EDIT SONG editor selected; in this case, press the “Menu” command to return to the main EDIT SONG menu):

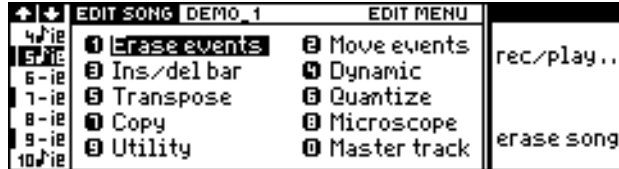

10. Access the Utility editor:

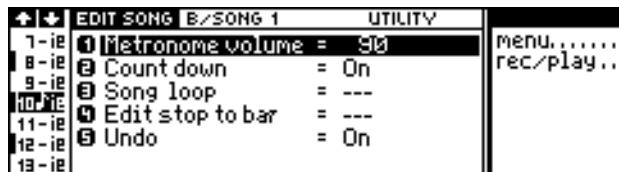

11. Activate the edit of the “Edit Stop to Bar” parameter:

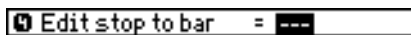

12. Use the NUMERIC KEYPAD (or the DIAL) to specify the last bar of the recording. At the end of the specified bar, the recording will stop automatically.
13. Select the “Rec/play” command to return to the Playback display.
14. Press RECORD to enter the “Record pending” display. Repeat the track selection process and the selection of the options as already described.

Now record the Song

15. With the “Record pending” display showing, press **PLAY** and start to play. The tracks shown with the “R” symbol will be recorded (provided that they are active in **LOCAL** or **MIDI IN**).
16. End your recording with **STOP**. If you have programmed the “Edit Stop to Bar” parameter, the recording stops automatically at the end of the selected bar of the Song pointer.
17. You can use the “rewind” button (<<) to go back to any point of the Song, press the **STOP** button again to return to the beginning, or modify the “Locator” parameter to reach a precise point. You can press **PLAY** to record other notes (adding new notes in “Overdub”, or substitute old notes with new ones in “Replace”).
18. During the recording you can select a different Performance (in the currently selected Bank/Song). You can also make use of the Function Controllers, the pedals and the wheels.

If you are recording with the “Tempo rec” option activated, all Tempo variations effected from the control panel (but not via **MIDI**) will be recorded. Vary the Tempo using the **DIAL**, in the appropriate window which opens when you press **CLOCK**:



“Clock” window: Rotate the dial to modify the Tempo and escape with **EXIT**.

19. Press **RECORD** to escape the “Record pending” display and to recall the Playback display:

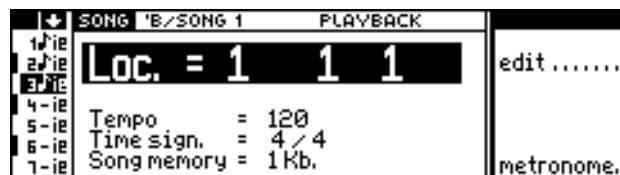

20. If you want to record other tracks, or the same tracks in “Overdub” or in “Replace”, repeat the procedure from the beginning (point 1).

Recording methods

There are two Song recording methods to choose from:

- record all the tracks of the Performance in a single step; in this way you can secure a live performance;
- record one track at a time, creating the Song by superimposing the instrument parts that make up the Song.

In the first case, set all the tracks required of the Performance in **Record**. If you want to change Performance during the recording, activate all the tracks that you think you will record (nevertheless, you will only record the tracks in which notes or **MIDI** events are effectively inserted).

In the second case, activate one track at a time. If you are recording from a keyboard or master keyboard via **MIDI-COMMON**, activate the *single* mode for the **LOCAL** source. Repeat the recording procedure for each track until the song is finished.

While you are recording new tracks, those already recorded will be heard in playback. If you want to isolate the track in record, press the **SOLO** button.

When you record jazz, rock, pop, etc. music, it is generally best to record the drum track first, then the tracks dedicated to the accompaniment, then the melody. The drum track (drumkit) is usually assigned to track 10 (to conform to **GM** standards). If you are not an expert with the Sequencer, listen to the demonstration Songs supplied by **Generalmusic**; they are excellent examples of how the S Series can be programmed.

10 REAL TIME SOUND EDITING

This chapter explains how to tweak (rapidly edit) some Sound parameters while performing, for example, a concert. The modifications described could be required for creative purposes as well as for reasons of rendering the music being played more suitable on stage, otherwise considered perfect in the studio.

The S Series keyboard models are equipped with hardware Function Controllers. This system of sliders and keys gives direct access to some of the more important parameters of the Sounds assigned to the tracks and provides a means of instantly cancelling the real time modifications made, by means of a “reset” function.

The rack model contains software Function Controllers, which allow a not so rapid but nevertheless powerful access to the Sound parameters.

The modifications can be saved in the Performance and - eventually - to disk for future use. Saving to the Performance is essential, to avoid cancelling the modifications when you select a different or the same Performance (operations which would annul any modification carried out).

The S2/S3 hardware Function Controllers

The Function Controllers are located on the extreme left of the S2/S3 control panel; they consist of seven sliders and eight buttons identified by silk-screened numbers, letters and parameter names.

*Note:
The MASTER VOLUME
slider is not included as
one of the FUNCTION
CONTROLLERS.*

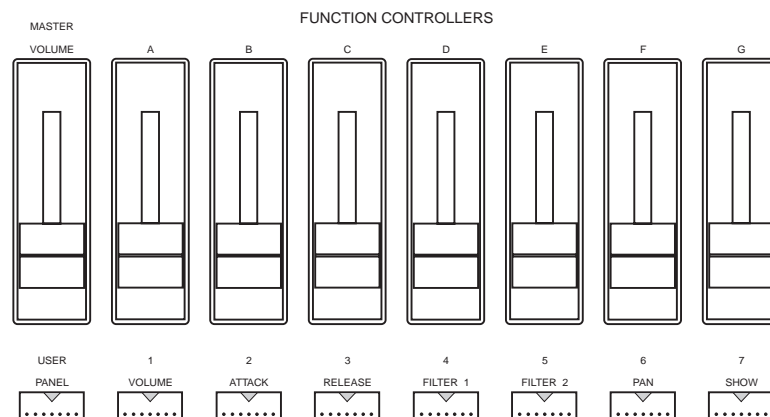

The Function Controllers have two operating modes:

- if the led on the USER/PANEL button is off, the Function Controllers operate in PANEL mode (= as indicated on the control panel);
- if the led on the USER/PANEL button is on, the Function Controllers operate in USER mode (= user programmable).

PANEL mode

In this mode, each cursor affects one of the seven tracks currently shown in the display. Both cursors and tracks are identified by a letter of the alphabet (A-G). The tracks can be scrolled but the correspondence between cursors and tracks is shown at all times by these letters.

Six buttons are identified with the name of a Sound or Track parameter: Volume, Attack, Release, Filter 1, Filter 2, Pan. The last button activates the Show function, which displays the current status of the active parameter for the seven tracks.

Example: How to modify the Track Volumes

1. Select the VOLUME button (is necessary).
2. Regulate the volume of the seven track that appear in the display by moving the seven cursors.

Example: How to modify the Release of the Sounds

1. Select the RELEASE button (if necessary).
2. Regulate the Release time of the Sounds assigned to the tracks which appear in the display by moving the seven cursors.

* Attack, Release, Filter 1, Filter 2. parameters

The “F.C.” symbol When a Sound* parameter is modified with the Function Controllers in PANEL mode, the symbol **F.C.** (=Function Controllers) appears in the top right hand corner of the main display.

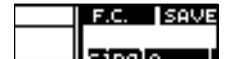

This is a reminder that the Sound parameters have been altered with respect to the original status memorised in the Performance. To recall the default status of the parameters, select the “F.C. Reset” command which appears in the SHOW display (s. below).

The SHOW BUTTON This button activates a graphic representation of the currently active parameter (Volume, Attack, Release, Filter 1, Filter 2, Pan):

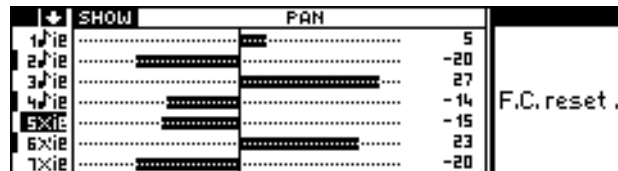

This display is only an indicator of the current parameter status; the elements displayed cannot be modified with the Data Entry commands. If, however, you move the cursors, the graphic representation changes accordingly.

Each horizontal bar reflects the current status of one of the tracks shown in the display. The current parameter value is also shown next to the bars.

To visualise the status of one of the other parameters, simply press the corresponding button of the Function Controller group.

The “F.C. RESET” command in the SHOW DISPLAY Select this command to recall the default settings of the parameters of the Sound (Attack, Release, Filter 1, Filter 2).

USER MODE

In this mode, both cursors (A-G) and keys (1-7) operate as programmed in the currently selected Performance. The Function Controllers can be programmed in EDIT PERFORMANCE/CONTROLS, pages 3 and 4:

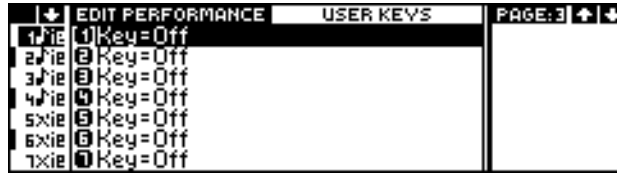

Keys

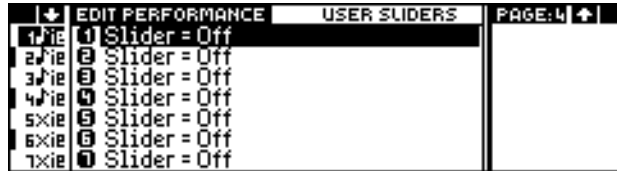

Sliders

The Function Controllers (sliders and keys) are independently programmable for each Performance. In USER mode, you can assign a parameter and a track to each slider and key. This will permit the control of tracks not currently shown in the display.

Example: Assign a Program Change to key 2 for track 16.

1. Select and activate the edit of “Key” 2.
2. Select a parameter to assign to the key, in this case a Program Change.
3. Press ENTER to pass to the second part of the line (“V”).
4. Assign a value to the Program Change.
5. Press ENTER to pass to the third part of the line (“Tr”).
6. Select a track number to which the Program Change is to be assigned.

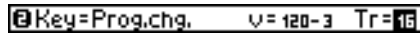

Key 2 (in USER mode) will recall the indicated Program Change for track 16. This operation assigns the corresponding Sound to track 16 and sends the relative message (Program Change 120 and Bank Select 3) to the MIDI OUT destination.

The S2R Function Controller

S2R contains a software Function Controller, accessed in page 3 of EDIT PERFORMANCE/CONTROLS:



1. Select a parameter in the options column (Volume, Attack, Release, Filter 1, Filter 2, Pan). The central part of the display shows a graphical representation of the parameter for the tracks that appear in the track column. The current parameter value is also shown next to the horizontal bars.

2. Select a track that requires the modification.
3. Rotate the DIAL or specify the parameter value with the NUMERIC KEYPAD.
4. Select another track, as required, and repeat the operation.
5. Select another parameter, as required, and carry out the modifications.

Example: How to modify the track Volumes

1. Select the VOLUME button (if necessary).
2. Select the first track to modify and rotate the DIAL or insert the value with the NUMERIC KEYPAD.
3. Select other tracks and repeat the operation.

Example: How to modify the Release of the Sounds

1. Select the RELEASE parameter (if necessary).
2. Select the first track to modify and rotate the DIAL or insert the value with the NUMERIC KEYPAD.
3. Select other tracks and repeat the operation.

* Attack, Release, Filter 1,
Filter 2. parameters

The “F.C.” symbol When a Sound* parameter is modified with the Function Controller, the symbol **F.C.** (=Function Controllers) appears in the top right hand corner of the main display.



This is a reminder that the Sound parameters have been altered with respect to the original status memorised in the Performance. To recall the default status of the parameters, select the “F.C. Reset” command which appears in the Function Controller page.

The “F.C. RESET” command in the FUNCTION CONTROLLER DISPLAY Select this command to recall the default settings of the parameters of the Sound (Attack, Release, Filter 1, Filter 2).

Save the modifications to the Performance

The modifications made with the Function Controllers must be memorised to avoid losing them when you select the same Performance or a different Performance.

In the main display, select the **Save Performance** command and confirm the memorising procedure. You can memorise the modifications in the current Performance, or in another Performance of the same Bank/Song or of another Bank/Song.

If you select another Performance, remember that, as well as the modifications made with the Function Controllers, you will also memorise all the other Performance parameters (Sound, Transpose, Volume...). This operation is equivalent to the creation of a new Performance, if necessary to replace another.

The modified Performance will be cancelled when the instrument is turned off. Save the relative Bank/Song to a floppy disk or to RAM-disk if the Performance is required for future use

Note: The modifications made to the Performance caused by the messages received at MIDI IN (Volume, Pan, Effects selections and Effects Volume changed) do not trigger the appearance of the “F.C.” symbol and cannot be memorised in the Performance.

11 EDITING SOUNDS IN THE STUDIO

The S Series instruments are equipped with very powerful Sound editing facilities. Sounds can be modified or created by means of a highly refined editing system. The general techniques of synthesis are discussed in the first part of this manual.

To access the EDIT SOUND environment, you must (a) assign the Sound you want to edit to the currently selected track, then (b) press the SOUND button in the Edit* section:

* The led on the button can show the status of the EDIT SOUND:
- it is on for the duration of the edit tasks for the sound in edit;
- it flashes when you temporarily escape EDIT SOUND provided that the "Save" or "Abort" command is not selected (the Sound remains in edit).

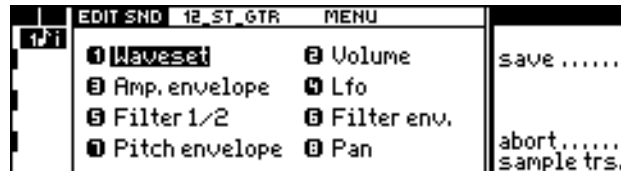

Detailed instructions of the EDIT SOUND procedures are in the *Reference* section. This chapter discusses the general procedures, which can be useful as a first approach to the modification of existing Sounds. If you are interested in the synthesis of Sounds with a view of intensifying your knowledge, it can be very useful to start with an analysis of the existing Sounds, and then proceed with the simple modifications which will give you an idea of all the possibilities available from the EDIT SOUND environment.

Types of Sound

The three fundamental Sound types

The S Series can house three fundamental sound types in the Sound Library:

SO (Single Oscillator) Sounds generated by the action of only one oscillator. The oscillator reads only one Waveform. These Sounds provide a maximum polyphony of 32 notes.

DC (Dual Crossfade) Sound generated by the action of two oscillators, which read only one Waveform. These Sounds provide a maximum polyphony of 16 notes, but obtain a very high quality of Sound.

DO (Dual Oscillator) Sounds generated by the action of two oscillators, each reading a different Waveform. These Sounds provide a maximum polyphony of 16 notes, producing complex sounds.

The Sounds can be converted into any one of the three types of Sound. The converting command is found in the edit WAVESSET editor.

The combinations: Sound Patch and Drumkits

The fundamental Sound types can be combined together in the Sound Patch sounds and the Drumkits. These combinations reside in the Sound Library together with the fundamental Sound types, but they are identified with the symbol IIII.

Sound Patch In their simplest form, they are two superimposed Sounds assigned to all the notes of the keyboard and separated by a dynamic threshold where the Sound on the higher dynamic level is recalled by striking the keys harder. In the more complex forms, these Sounds can consist of several zones assigned to different parts of the keyboard, each with two superimposed sounds separated by a dynamic threshold.

Drumkit Set of percussion instruments, each one assigned to a different note of the keyboard. The Drumkits are Sound Patches of a particular type. These "sounds" are modified in the same edit environment as the Sound Patch (EDIT SOUND PATCH).

ROM-Sound, RAM-Sound, RAM Sound

The S Series houses over 500 permanent Sounds, called ROM-Sounds. These Sounds cannot be cancelled or modified, but, starting from a Rom-Sound copy, you can apply one or more modifications to produce RAM-Sounds.

RAM-Sounds are user-created Sounds, which can be saved to disk as a Setup Sound Library.

The RAM  Sounds are RAM-Sounds based on Waveform created with the Sample Translator, or loaded from floppy disks.

The Sounds are all organised and accessed in the Sound Library.

Waveform

There are two types of Waveform:

Rom-Waveform Waveform contained in Rom. These are the waveforms which are the basis of the Rom-Sounds and the Ram-Sounds (not the Ram-Sound with the symbol ).

Ram-Waveform Waveform created with the Sample Translator or loaded from commercial floppy disks. These waveforms are the basis of the Ram-Sounds with the symbol  (Ram  Sound).

The Waveform or Waveforms upon which the Sounds are based are selected in the WAVESET editor.

Filters

The filters and the Cutoff-frequency

In the Sounds, the Waveforms are modified by two state-variable 2-pole filters connected in series (Filter 1 → Filter 2). The programmable filters enrich or impoverish the harmonic content of the sound.

Each filter can be set to operate as one of the following:

low-pass . Attenuates the higher frequencies, allowing only the lower frequencies to pass.

high-pass. Attenuates the lower frequencies, allowing only the higher frequencies to pass.

band-pass. Attenuates the frequencies above and below a given frequency.

parametric-boost. Enhances a given frequency.

parametric-cut. Attenuates a given frequency.

The frequency at which the Filter begins to “cut into” the harmonic band of a waveform is called the “cutoff-frequency”. This frequency is programmable and it corresponds to the level at which the filter acts on all the notes of the Sound.

The cut-off frequency can, however, be modified across the keyboard scale by means of the “Filter Tracking” (*s.*) parameter.

Resonance

Resonance creates a high peak of emphasis at the cut-off frequency, rendering the harmonic content of a sound richer. This parameter is commonly used to create “analog” type sounds.

The filter envelopes

The DC and DO Sounds can be affected by dynamic filters which can be made to vary over time. The variation is programmed by means of an Envelope (*s.*). The Filter Envelope is extremely useful to render a sound “live”.

Envelopes

Types of Envelopes

The envelopes vary the quality of the Sound over time. There are the *Key On Envelopes*, which affect the Sound continuously during the period that the note is held pressed, and the *Key Off Envelopes*, which affect the Sound after the note has been released (Release phase).

The S Series Sounds can have programmable envelopes for the following sound parameters:

Amplitude The Amplitude Envelope represents the Volume displacement in relation to time. In the most common cases, the Volume of a sound increases sharply immediately after attack, then there is a sharp decay to a lower level, then it remains more or less at a constant level (such as Strings) or decays slowly (such as the Piano). In the phase that follows the release of the note, or the “key off” phase, the sound gradually fades to “zero” level. With the synthesizer it is also possible to create non-realistic envelopes.

Filter The Filter Envelope modifies the cut-off frequency over time, modifying, therefore, the harmonic content of the timbre being affected. SO Sounds cannot be affected by this envelope.

Pan The Pan Envelope modifies the position of the sound within the stereo panorama over time. (This editor is not available for SO Sounds).

Pitch The Pitch Envelope modifies the Pitch of the sound over time. This parameter can be useful to simulate the unpredictable initial pitch of Brass or Strings sounds.

Balance Only available for the DO Sounds. The Balance Envelope (in reality it corresponds to the Pan Envelope or to the Pitch Envelope) varies the Volume displacement over time of the two oscillators which constitute the Sound.

Programming the envelopes

The envelope edit pages consist of a graphic parameter. For example, the following display shows the Key On Amplitude Envelope, identical to all the other envelopes:

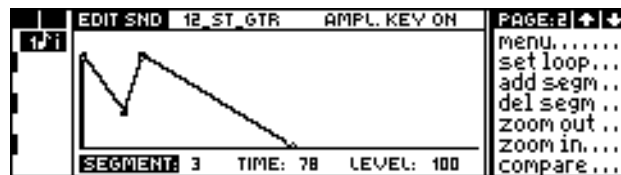

Segment A section of the selected envelope.

Time Duration of the segment.

Level Generally, the level reached by the parameter when the segment of the selected envelope is played. For.ex. in the Amplitude Envelope it represents the Volume of the sound, in the Filter Envelope it is the cut-off frequency, in the Pan Envelope it is the position of the sound.

Use the following procedure to modify the envelopes:

1. Press ENTER repeatedly to select one of the parameters: "Segment", "Time", "Level".
2. Rotate the DIAL to select a "Segment", modify its relative "Time" or "Level" value. The "Time" and "Level" values can be inserted with the NUMERIC KEYPAD.
3. Press ENTER to select the next parameter. After "Level", the "Segment" parameter will be selected again.
4. Select the "Add segm." command to add a new segment directly after the one selected. Select the "Del. segm." command to cancel the selected segment.

Tracking

Types of Tracking

Tracking follows the movements of a parameter across the keyboard. In practice, you can control the variation of a parameter (Volume or Pan) with respect to the note played. Tracking is indispensable for the correct simulation of real sounds, because it renders the lower, medium and high frequencies of the scale homogeneous.

Tracking can be applied to the following parameters:

Volume Volume Tracking modifies the volume of the Sound across the keyboard.

Pan Pan Tracking modifies the position of the sounds in the stereo panorama across the keyboard. For.ex. the higher frequencies can be moved to the left and the lower ones to the right (or vice-versa).

Filter Filter Tracking modifies the cut-off frequency with respect to the note played. It is useful to avoid the complete "filtration" of the notes above the cut-off frequency. It is also useful to provide more or less "brilliance" to the sound across the keyboard.

Amplitude Envelope The Amplitude Envelope Tracking modifies the completion velocity of the Amplitude Envelope across the keyboard. Acoustic instruments are characterised by having a shorter (faster) envelope for the higher notes with respect to the lower ones.

Filter Envelope The Filter Envelope Tracking modifies the completion velocity of the Filter Envelope across the keyboard.

Pitch Envelope The Pitch Envelope Tracking modifies the completion velocity of the Pitch Envelope across the keyboard.

Programming the Tracking

The Tracking edit pages consist of a graphic parameter. For example, the following display shows the Amplitude Envelope Tracking curve, almost identical to all other Tracking curves:

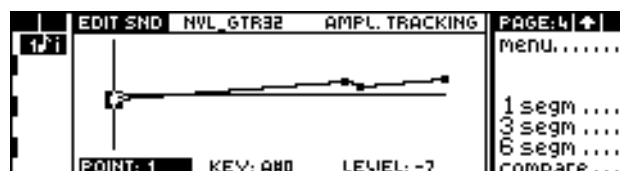

Point One of the extreme ends of the selected segment of the Tracking.

Key The keyboard position corresponding to the Point in edit. The Points at the extremes have a Key parameter which cannot be modified (A#0, G8).

Level Determines the offset value of the envelope or sound parameter at the selected Point (Volume Tracking curves have negative Level values, because they represent offset values with respect to the maximum Volume of the Sound).

Use the following procedure to modify the Tracking:

1. Press ENTER repeatedly to select one of the parameters: “Point”, “Key”, “Level”.
2. Rotate the DIAL to select a “Point”, modify its relative “Key” or “Level” value. The “Key” and “Level” values can be inserted with the NUMERIC KEYPAD. (“Key” can also be represented in numeric form: each MIDI note is numbered. Middle C — C4 — has the MIDI note number 36).
3. Press ENTER to select the next parameter. After “Level”, the “Point” parameter will be selected again.

Lfo, Pitch, Pan

Lfo

Lfo is a low frequency oscillation which can be applied to generate interference in a sound. In the S Series, the Lfo can be applied to the following sound parameters:

Pitch Vibrato effect.

Amplitude Tremolo effect.

Filter1/Filter2 “Wah-wah” effect.

The LFO oscillation can have a programmable waveform, selected among *Sinus, Triangle, Saw, Square, Random, Sample&Hold*. (S. Reference, chapter Edit Sound).

Pitch

The pitch of a note can be subjected to changes while a note is held pressed (Key On Pitch Envelope) or in the Release phase (Key Off Pitch Envelope).

The Pitch Envelope can be useful to simulate the small pitch variations characteristic of acoustic sounds (listen to *Brt_Piano* [2-1]) as well as for creative effects (listen to *Devil* [89-4]).

Pan

The Pan is the position of the sound within the stereo panorama (stereo outputs pairs: LEFT+RIGHT, 1+2, 3+4). Pan can be modified in a fixed manner across the keyboard with Pan Tracking, or dynamically with the Pan Envelope.

Memorising the Sound in the Sound Library

Escape from EDIT SOUND

After having created or modified a Sound, it is possible to escape from EDIT SOUND, saving it or cancelling the modifications made.

Escape EDIT SOUND and cancel the modifications

Select the “Abort” command in the main menu. Confirm the “Are you sure?” dialogue window with ENTER.

Escape from EDIT SOUND saving the Sound in the Sound Library

1. Select the “Save” command from the main menu. The Sound Library page is displayed:



2. If you have edited a RAM-Sound, and want to save the modifications in the source Sound, select the “Store” command. Confirm “Are you sure?” with ENTER.
3. If you have modified a ROM-Sound, you must select a free location (-- -- -- --). Rotate the DIAL to select the new location for the Sound, then select the “Store” command. Confirm “Are you sure?” with ENTER.

Note: If you want to change the name of the Sound, select the “Name” command before selecting “Store”:



Insert the characters with the alphanumeric keypad:

Insert: inserts a space as the cursor position.

Capitals: allows the insertion of uppercase letters.

Delete: cancels an entry at the cursor position.

ENTER to confirm, EXIT to annul.

Save the Sound Library to disk

The Sounds are stored in the Sound Library. The Sound Library stores all types of Sound (ROM, RAM, RAM ↕), organised in Family groups*.

* The ROM-Sound Families are listed in the Appendix.

The Sound Library can be modified (Sound remappings, new RAM-Sounds) and saved to disk as a Sound Library Setup.

The save Sound Library Setup procedure is described at the beginning of the section in chapter *Save the contents of memory to disk*. S. also the Reference section in chapters *Disk* and *Sound Library*.

The Sound Library Setup can be loaded from disk. If the disk containing the Sound Library is inserted in the disk when you power up, or if the Sound Library is stored in the RAM-disk, the Sound Library Setup will be loaded to memory automatically when the instrument is turned on and the standard Sound Library residing in ROM will be modified.

12 SELECTING THE SOUNDS VIA MIDI

Selecting the Sounds with Bank Select and Program Change

The Sounds assigned to each track can be selected via MIDI with appropriate Program Change and Bank Select* messages.

Each Sound is identified by a Program Change number and a Bank Select number, displayed near the name of the Sound (in Sound mode):

	B/S	DEMO	P	EUROPE	
1/16		Devil	89-	4	PERF.....
2/16		SYNTHEX_4	103-	4	single.....
3/16		El_P_Glock	6-	7	
4/16		Rock_Organ	19-	1	
5/16		Nyl_Guitar	25-	1	
6/16		Dyn_Slap_BM	37-	2	
7/16		Strings_2	50-	1	

Sound names

Program Change

Bank Select

*Note:
The Bank Select message does not refer to the S2R Bank/Songs. It is a standard MIDI message which permits the selection of the "variation" tones of the basic Sounds with Program Change and Bank Select numbers of the type XXX-1.

The S2/S3 User Manual refers to this message as "Extended Program Change".

The S Series uses the term "Bank" in two different cases:
- Bank/Song (Bank of Performances);
- Bank Select or Sound Bank (Bank of Sounds).

The Program Change and Bank Select numbers also appear in the Sound Library, which is accessed by pressing the SOUND LIBRARY button:

SOUNDS LIBRARY		FAMILY	
		Family:	Piano
			search
			srch next ..
			MASK.....
			move
			delete.....
			imp_disk..
			imp_rand..

Sound names

Program Change

Bank Select

The Sound map, with relative Program Change and Bank Select numbers appears in the Appendix.

The Program Change

To change the Sound assigned to each track, it is possible to transmit (from a sequencer of a master keyboard not connected via MIDI-COMMON) a different Program Change message to each track.

The Program Change is a standard message, available in all sequencers. With the Program Change message, it is possible to select only the Sound with the Bank Select number "1".

In the S Series, the Program Change numbers range from 1 to 128. Some instruments and sequencers use the numbering system based on the range 0 to 127.

The Bank Select (MIDI Controller 0)

Note: Bank Select "1" is not obligatory.

The Bank Select message has only recently become a standard, therefore, it is quite possible that some sequencers are not able to send this message. Some sequencers implement this message as "MIDI Controller 0".

For example, the Steinberg Cubase™ sequencer can send this message in various different ways. In order to be received correctly by the S Series, it must be assigned to the track of the Song (in Cubase the song is called, Arrangement). The Bank Select is inserted before the Program Change.

1. Create a track in one of the “Arrange” windows of Cubase:

Note: Sequencers of other manufacturers will most probably use different procedures and terminology. Consult the relative owner's manual.

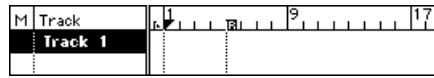

2. Create a Pattern at the beginning of the track:

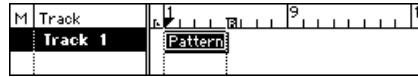

3. Select the Grid command from the Edit menu. The “Grid Edit” palette will open.
4. Select the “pencil” tool:



5. Select the “Control Change 0” MIDI event. “Control Change 0” is called “Bank Select”:

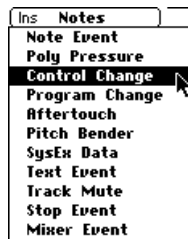

Start Position	Length	Val 1	Val 2	Val 3	Event Type
1. 1. 48	----	0	0	---	BankSel.MSB

6. Assign the number to the “Bank Select” event (in the Val2 column in Cubase™). In this window, Cubase™ shows the numbers according to the range “0 ~ 127” and not the range “1 ~ 128” of the S Series; scale down by one number to insert the correct Bank Select number.
7. Select the “Program Change” MIDI event. Insert the “Program Change” event directly after the “Bank Select” event:

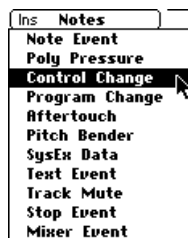

Start Position	Length	Val 1	Val 2	Val 3	Event Type
1. 1. 48	----	0	3	---	BankSel.MSB
1. 1. 96	----	15	---	---	Program

8. Assign the correct number to the “Program Change” event, bearing in mind that Cubase™ conforms to the range “0 ~ 127” and not “1 ~ 128” of the S Series; scale down by one number to insert the correct Program Change number.

Select the Sounds via the Performance Change event

If the sequencer or master keyboard that you are using is not able to transmit the Bank Select message (Control Change 0), it will not be possible to select Sounds with Program Change numbers other than the type XXX-1 and, therefore, not the “variation” of the basic Sounds.

You can, however, program your Performances accordingly, and select them with a Performance Program Change message.

You must activate the MIDI-COMMON channel and assign it one of the 16 MIDI channels, bearing in mind that the channel assigned can no longer be used for instrument data.

Programming the MIDI-Common channel

1. Press the GENERAL button to access EDIT GENERAL:

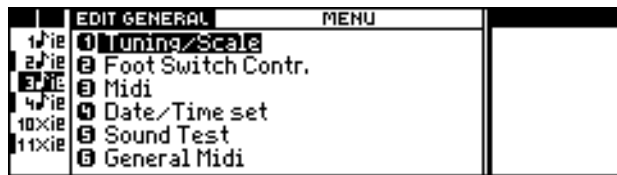

2. Specify 3 on the NUMERIC KEYPAD to access the “Midi” editor:



3. Press 1 to activate the edit of the “Midi Common” parameter:

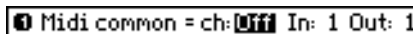

4. Specify the required MIDI channel, for example, channel 16; and press ENTER:

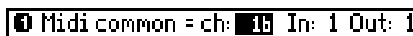

5. Press ENTER three times to confirm the programming:



6. Press NORMAL to return to the main display:



Select the Performances via MIDI-COMMON

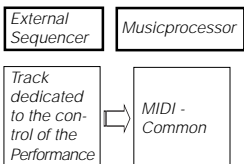

Dedicate one of the tracks of the external sequencer’s song for the purpose of sending Performance Program Change data (assigned the same MIDI channel as the MIDI-COMMON). Insert the relative Program Change number slightly before the point where the Performance has to change.

The table in the following page shows the Program Change numbers that correspond to the 100 Performances of the S Series.

PC	Bank-Perf	PC	Bank-Perf	PC	Bank-Perf	PC	Bank-Perf	PC	Bank-Perf
1	1-1	11	2-1	21	3-1	31	4-1	41	5-1
2	1-2	12	2-2	22	3-2	32	4-2	42	5-2
3	1-3	13	2-3	23	3-3	33	4-3	43	5-3
4	1-4	14	2-4	24	3-4	34	4-4	44	5-4
5	1-5	15	2-5	25	3-5	35	4-5	45	5-5
6	1-6	16	2-6	26	3-6	36	4-6	46	5-6
7	1-7	17	2-7	27	3-7	37	4-7	47	5-7
8	1-8	18	2-8	28	3-8	38	4-8	48	5-8
9	1-9	19	2-9	29	3-9	39	4-9	49	5-9
10	1-10	20	2-10	30	3-10	40	4-10	50	5-10

PC	Bank-Perf	PC	Bank-Perf	PC	Bank-Perf	PC	Bank-Perf	PC	Bank-Perf
51	6-1	61	7-1	71	8-1	81	9-1	91	10-1
52	6-2	62	7-2	72	8-2	82	9-2	92	10-2
53	6-3	63	7-3	73	8-3	83	9-3	93	10-3
54	6-4	64	7-4	74	8-4	84	9-4	94	10-4
55	6-5	65	7-5	75	8-5	85	9-5	95	10-95
56	6-6	66	7-6	76	8-6	86	9-5	96	10-6
57	6-7	67	7-7	77	8-7	87	9-6	97	10-7
58	6-8	68	7-8	78	8-8	88	9-7	98	10-8
59	6-9	69	7-9	79	8-9	89	9-8	99	10-9
60	6-10	70	7-10	80	8-10	90	9-10	100	10-10

Warning: The Performance Program Change table shows numbers based on the range 1 ~ 128. Some MIDI controlling devices (master keyboard, sequencer) will be based on the range 0 ~ 127. In this case, scale down by one unit to obtain the correct Program Change data shown in the table.

13 SELECTING THE EFFECTS VIA MIDI

The Effects assigned to the two DSPs (digital signal processors), and their Effects Volumes, can be selected via MIDI. Owing to the fact the Effects are elements that relate to the Performances and not to the individual tracks, it is not possible to activate or deactivate an effect for each track via MIDI.

Effect 1 is a reverberation, *Effect 2* is a modulation (delay, chorus, flanger, phaser, rotary).

To control the Effects, use is made of the following MIDI-Controller data, received by the Music Processor on the MIDI-COMMON channel:

- selection of Effect 1: *Contr. 21* (with values 1...64 or 0...63)

- selection of Effect 2: *Contr. 22* (with values 1...64 or 0...63)

- control of Effect 1 Volume: *Contr. 23* (with values 1...128 or 0...127)

- control of Effect 2 Volume: *Contr. 24* (with values 1...128 or 0...127)

Programming the MIDI-Common channel

Follow the instructions outlined in the chapter “Selecting the Sounds via MIDI”.

Controlling the Effects via MIDI-COMMON

Dedicate one of the tracks of the external song (assigned the same MIDI channel as the MIDI-COMMON channel) to the control of the Effects. This track can be the same as that used to select the Performances via MIDI.

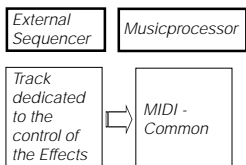

Insert the MIDI Controller event in the track dedicated to the MIDI-COMMON. The MIDI Controller data is divided into two parts: the first is the number that identifies the Controller (in this case, 21, 22, 23 or 24), the second is the value of the Controller, (in this case the number of the Effect — from 1 to 64 or from 0 to 63, according to the numbering system used by the external sequencer — and the value of the Effect Volume — from 1 to 128 or from 0 to 127).

For example: in the typical sequencer “Event List”, the MIDI Controllers could appear as follows:

Event Type	Val 1	Val2
Controller	21	4

Assignment of Effect number 4 to DSP 1.

14 EDITING SOUNDS VIA MIDI

It is possible to modify the following Sound parameters via MIDI: Attack, Release, Cutoff of Filter 1, Cutoff of Filter 2. Each parameter can be controlled via MIDI by an appropriate MIDI Controller, received by the track to which the Sound in edit is assigned. The tracks which receive this kind of data must be assigned a MIDI channel that is not the MIDI-COMMON.

ATTACK: Contr. 12 (0 = faster, 64 = standard level, 127 = slower).

RELEASE: Contr. 13 (0 = faster, 64 = standard level, 127 = slower).

FILTER 1 CUTOFF: Contr. 14.

FILTER 2 CUTOFF: Contr. 15.

FILTER 1 + FILTER 2 CUTOFF: Contr. 20.

Sound modifications via MIDI Controller data do not cause the appearance of the F.C. symbol in the main display, and they cannot be saved in the Performance.

The sound parameters tied to the tracks can also be modified (Volume and Pan):

VOLUME: Contr. 7.

PAN: CONTR 10.

15 PROGRAMMING WITH AN EXTERNAL SEQUENCER — PERFORMANCE 10 OF BANK/SONG 1

Songs can be recorded on an external sequencer in a simplified manner by exploiting Performance 10 of Bank/Song 1 (the default situation). This Performance is called “Local Off”.

Performance 10 is programmed in order to be able to send data to an external sequencer on MIDI channel 1, and to received data from the external sequencer on channels 1 to 15. Channel 16 is not used.

Most sequencers are preset to receive data on MIDI channel 1, and are configured so that the data received on this channel plays the currently selected track in the sequencer itself. Therefore, if the Music Processor display shows track 16 — in LOCAL — set to transmit on MIDI channel 1, you can play the sequencer track (currently selected or set to record) on the S2/S3 keyboard.

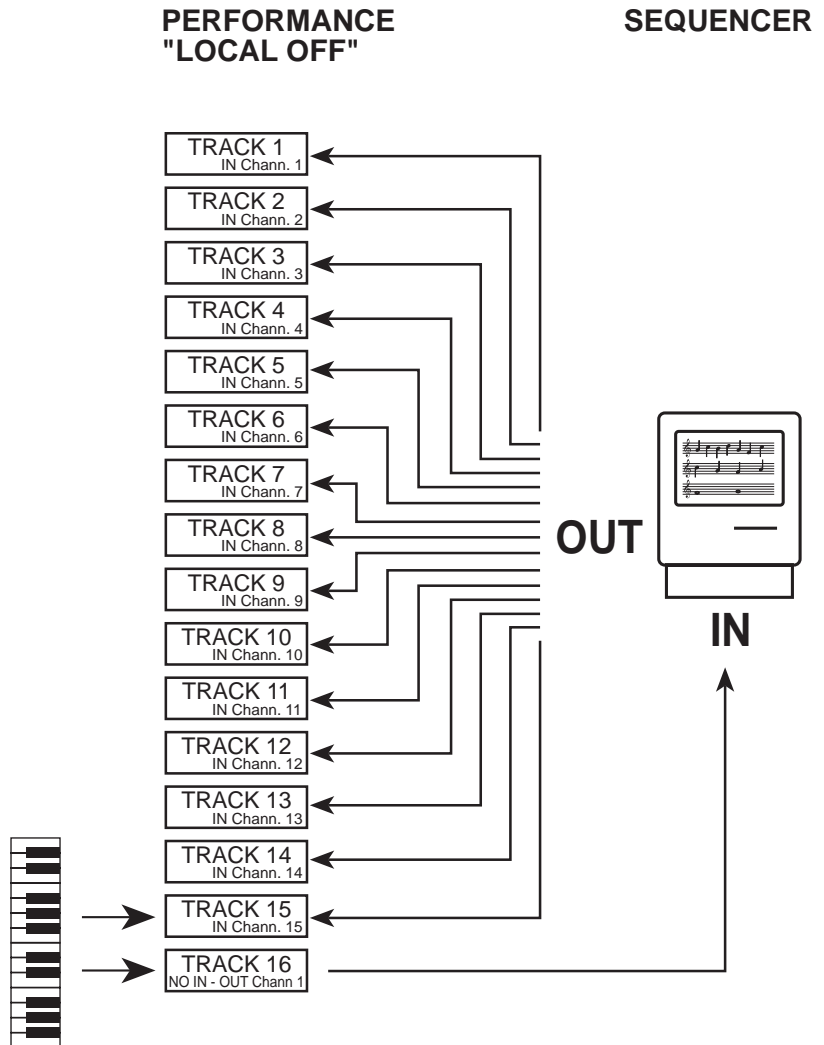

1. After powering up the instrument in default conditions (no floppy disk in the drive and no data in RAM-disk), select Performance 10 of Bank/Song 1.
2. Set the viewing mode for the LOCAL Source (and activate “Sounds” mode). If this Source does not appear in the display, press the LOCAL button in the Source section:

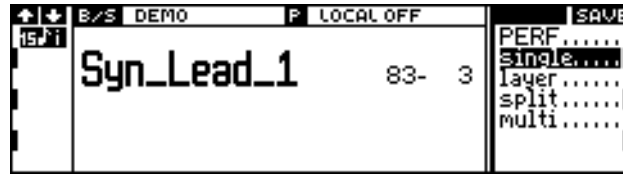

Performance “Local Off”, default, “Sounds” mode: On the keyboard it is possible to play track 15 (with the Sound “Syn_Lead_1”).

3. To send data to the external sequencer, press the RIGHT TRACK SCROLL BUTTON, to bring track 16 into view. The track will be shown selected. If you now play on the keyboard, the data generated will be transmitted to the external sequencer (on MIDI channel 1).

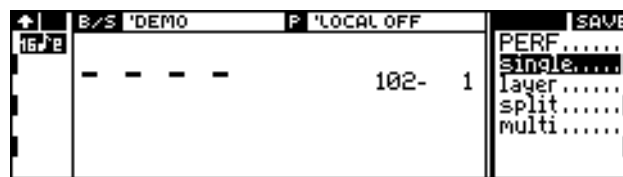

Performance “Local Off”, track 16. The keyboard transmits data to the sequencer (on MIDI channel 1).

4. The external sequencer transmits data to tracks 1 to 15 of the Music Processor. To see the status of the tracks that receive MIDI data, press the MIDI IN button in the Source section. The display shows the Performance tracks relating to the MIDI IN Source. The tracks receiving data are identified in the track column by the small dashes which appear while data is being received.

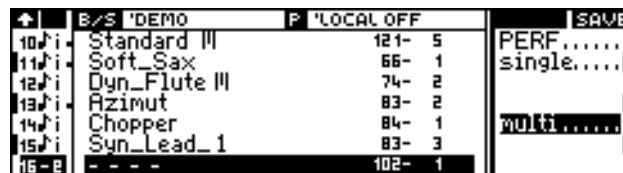

Performance “Local Off”, the tracks of the MIDI IN SOURCE:
The tracks receiving data from the external sequencer shows the small dashes (V-meter) in the track column.

5. Programme the Performance as required and selected the “Save Performance” command. You can assign the Effects, the Track Transpose, all the EDIT PERFORMANCE/CONTROL edited status as well as those from EDIT PERFORMANCE/TRACKS (s. Reference).

SAMPLE TRANSLATOR

□ SAMPLE TRANSLATOR 2.0

- Waveform theory
 - Conversion of Akai Samples and Programs into Waveform
 - Sample edit
 - Creating a Waveform and a Sound
-

Sample Translator 2.0

The Edit Sound menu includes the Sample Translator command, giving access to the Sample import and edit program.



About Sample Translator

The Sample Translator program enables you to:

- read samples from Ms-Dos/Atari floppy disks, in Avalon, Sound Designer, Sample Vision and Wave formats;
- read samples from Akai S1000 floppy disks;
- receive samples via MIDI;
- modify samples and create a multi-sample (the multi-sample becomes a standard Waveform of the Music Processor);
- modify the waveform of the RAM-Sounds that contain an imported sample (Sounds with the  symbol).

Previous versions of Sample Translator were available as User Programs. This manual refers to version 2.0, incorporated in the Turbokit ROM.

Waveforms and multi-samples

Every S Series Sound is based on a Waveform, the fundamental component of the Sound. The Waveform is a sampled sound that represents a brief “recording” of the first part of an authentic sound source. A Waveform usually comprises several of these recordings, executed in different keyboard ranges, so that sound quality is not impaired by transpositions of the sampled sound.

Quite obviously, every sampled sound is called a “sample”. As a Waveform is made up of several samples, it is referred to as a “multi-sample”.

S Series Waveform

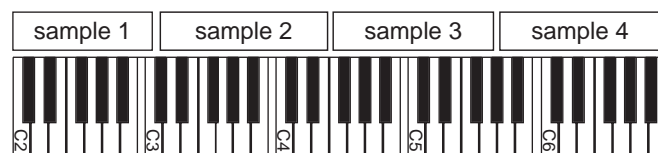

Sample Translator can modify several aspects of a multi-sample, such as the keyboard range to which a sample is assigned, the sample assigned to a range, the volume of each sample (“gain”) and “loop”.

A “loop” is a repetition of the last part of the sample, which usually comprises the Sustain and Release phases in the envelope.

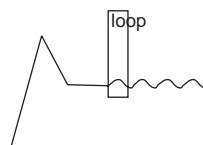

The “Waveform” display

The main Waveform display contains a list of the 16 samples that can compose the Waveform. Locations without samples are shown as “EMPTY”. The commands in the right-hand column are shown on 2 pages.

Note:
When the instrument is played in Local or Common, a small square may appear before the selected sample:

■ ^00 S BRASS C2

This symbol shows that the sample is playing, because the keyboard range to which the sample has been assigned is being played.



A sample can be selected by rotating the DIAL. The overall dimension of the Waveform (in kilobytes) is shown on the top line (“Size”).

Next to each sample, three notes are usually shown, representing the lower limit of the keyboard range to which the sample has been assigned, the original sample pitch, and the upper keyboard limit:

■ ^00 S BRASS C2-L C1 - D#3- D#4

The “Waveform” command functions

- Load:** Loads a sample into the selected location, from MIDI or a floppy disk.
- Save:** Saves the Waveform created. The samples to which an extension limit has been assigned with the Assign command become a part of the Waveform.
- Assign:** Assigns the selected sample to a keyboard range. This “assigned” sample plays together with the other “assigned” samples that make up the Waveform. The keyboard ranges to which the samples are assigned may not overlap.
- Unassign:** Cancels the extension limits of the selected sample.
- Play Single:** Gains access to a page that shows the waveform of the sample. On this page, the sample can be listened to on its own (even if it has been “assigned”); its level can be modified and it can be sent via MIDI to an external device (sampler, computer).
- Info About:** Gains access to a page that can display information about the dimensions of the Waveform and the sample selected, the pitch of the sample and the position of the Loop Start and Loop End points of the sample. The pitch and the loop points can be modified from this display.
- Exit:** Concludes your Sample Translator work session. If confirmed with **ENTER**, all samples present in the edit buffer are cancelled; if **EXIT** is pressed, you return to Sample Translator.
- Cut End:** Selectable/deselectable option. If selected, the parts that follow the Loop End of samples loaded after selection are cut off.
- Delete:** Cancels the selected sample from memory.
- Copy:** Copies the selected sample to a clipboard.
- Paste:** (Appears after a Copy command). Enables you to insert the copied sample at the selected location. This operation allows you to save memory, as the sample is not literally copied, but just read twice by Sample Translator.

Loading samples (“Load”)

There are four possible ways of loading one or more samples into Sample Translator:

- Access Sample Translator from a RAM-Sound based on a Waveform created with Sample Translator (many of the Sounds with the  symbol). If this is a DO Sound, the sample will be the sound produced by the first oscillator.
- Receive a sample via MIDI from a sample editor or sampler, in the 16-bit MMA_sds format (*Sample Dump Standard*).
- Read samples from Ms-Dos/Atari floppy disks, in Avalon, Sound Designer, Sample Vision or Wave formats.
- Read Samples or Programs from an Akai S1000™ floppy disk (HD format).

1. Loading a sample contained in a RAM-Sound

Note: This operation can be carried out only with RAM-Sounds having a Waveform created by Sample Translator.

1. Assign a RAM-Sound with a Waveform created by Sample Translator (many of the Sounds with the ) to a selected track:

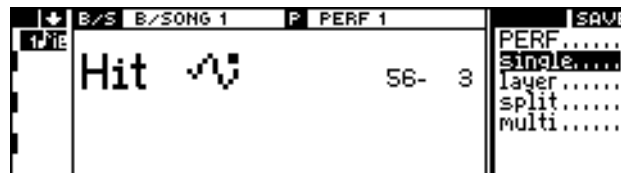

Note:
The Sample-RAM (RAM dedicated to samples) has a 2 megabyte capacity. It is therefore impossible to enter edit with a Waveform made up of more than 1 Megabyte of samples. In general, it is not possible to access edit if the overall size of the samples present in RAM and the sample to be edited exceeds 2 Megabytes.

Sample TRS

2. Access **Edit Eound** and then Sample Translator.

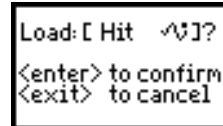

If the RAM-Sound contains a Waveform that was not created by Sample Translator, the Waveform will not be loaded. If the Sound is a DO type, the Waveform will be loaded only if it is used by the first oscillator.

2. Loading a sample via MIDI

Check that the following connections with the sampler or computer have been made:

- The Music Processor’s MIDI OUT 1 socket to the MIDI IN socket of external device;
- The Music Processor’s MIDI IN 1 socket to the MIDI OUT socket of external device.

If Midi Common is “Off”, the external device must transmit on Channel 1. If Midi Common is “On”, the external device must transmit on the Midi Common channel.

1. From the Waveform display, after having selected a location for the sample, choose the Load command:



* Samplers that operate on the MMA_sds standard (Sample Dump Standard) identify the memorized sample with a number (0~255). To shift a sample from one device to another, the sample number must correspond on both devices.

- Use the **DIAL** to select MMA_sds and press **ENTER**. The Music Processor requests the number* of the sample to be received from the external device (0~255):



- When the sample number has been given, press **ENTER** to start reception:

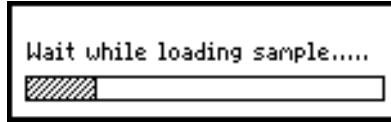

The sample received will occupy the location selected in Waveform:



To receive other samples, select another location with the **DIAL** and repeat the operation. A previously imported sample can be replaced by another.

Reception errors If connections have not been made correctly, or if the external device is unable to send the sample in MMA_sds format, the following error messages appear:



Check the connections. If no fault is discovered, check the transmission channel of the external device (the Music Processor receives on channel 1 if Midi Common is "Off", or on the assigned Midi Common channel if Midi Common is "On").

It is also possible that the external device is unable to receive the Dump Request message transmitted by the Music Processor. In this case, return to the Waveform display and start the transmission directly from the external device.

3. Loading samples from Ms-Dos/Atari floppy disks

* The Wave format (.WAV) is the standard format of sounds under Windows.

**To save samples created with an Apple Macintosh computer on an Ms-Dos disk, programs such as "Apple File Exchange", "AccesPC" or similar must be used. For Commodore Amiga files, use the "Dos2Dos" program or similar.

If you have a computer and a sample editing program that can save data in Avalon, Sound Designer, Sample Vision or Wave* formats, the Music Processor can read samples created with the editor from floppy disks. The floppy disk must be formatted Ms-Dos or Atari (720k)**.

1. From the Waveform display, after having selected a location for the sample, activate the Load command:



2. Press ENTER and use the DIAL to select "Dos/Atari":



3. Press ENTER; the directory of the Ms-Dos/Atari floppy disk will appear:

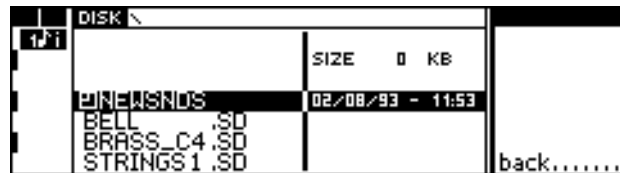

The items marked with the symbol are sub-directories (S. Disk) that can contain samples. Access the sub-directory by pressing ENTER, and return to the main directory with the BACK command.

4. Use the DIAL to select a sample and press ENTER to load it in the location selected in Waveform.

Conversion limits Some samples deactivate Detune (which, when edited in the Waveset editor, operates as a Fine Pitch function):

Note:
Samples which cannot enable the Detune parameter have Loop Start and Loop End points with widely differing amplitudes. To correct this problem, select the Loop Start and Loop End points with similar amplitudes, using an external sampling editor.

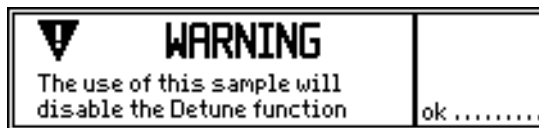

These Sounds cannot be converted in SO or DO:



4. Loading Samples and Programs from an Akai S1000 floppy disk

- **Akai S1000™ Samples and Programs**

Akai samplers compatible with S1000 save two types of data on floppy disks: Samples (equivalent to the S Series samples) and Programs (similar to the S Series Waveforms).

A Program organizes the Samples by defining the keyboard ranges to which they are assigned. Unlike the Waveform of the S Series, an Akai Program can distribute the Samples over several different “Levels” (dynamic levels). The S Series Waveform can distribute Samples only on a single dynamic level.

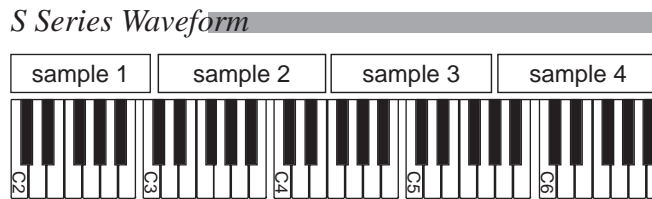
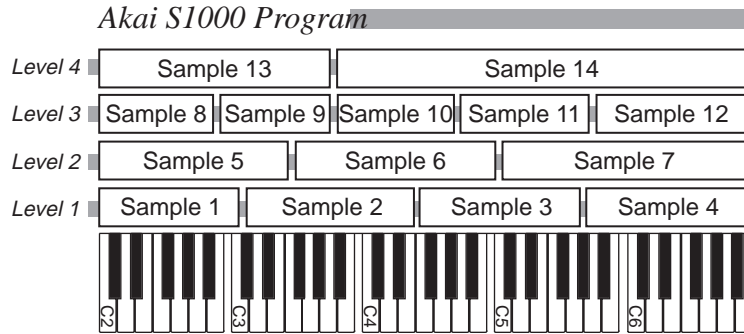

Sample Translator can load single Samples, or in a single operation, it can convert an entire “level” of the S1000 Program into an S Series Waveform. If a Program contains more than one “level”, it can be converted entirely in successive phases, using (a) a Sound Patch, (b) a multi track configuration, with different dynamic ranges for each track.

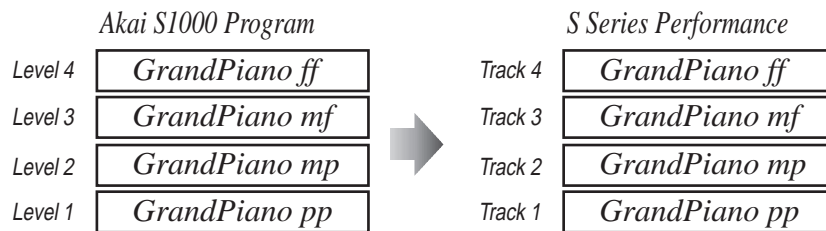

- **Conversion limitations**

A Waveform can contain only 16 samples. As an S1000 level can contain up to 99 Samples, when a conversion is carried out only the 16 Samples from the lowest register are loaded.

S1000 Samples can overlap even inside a dynamic Level. Sample Translator eliminates this overlap, using the lowest limit-note of the highest pitched sample as the limit between samples.

Some samples do not allow Sounds created with Sample Translator to be converted into SO or DO types.

• *Loading a Sample or Program*

1. From the Waveform display, after having selected a location for the sample, choose the Load command:



2. Press ENTER and use the DIAL to select "Akai":



3. Press ENTER; the directory of the Akai S1000 floppy disk appears. The Samples show the letter "S" extension, and the extension on Programs is "P":

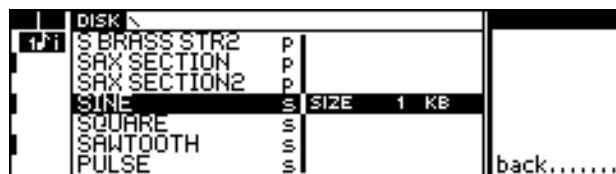

4. Select a Sample or a Program with the DIAL, and press ENTER to load it into the Waveform.
 - If you are loading a Sample, this will occupy the location selected in the Waveform.
 - If you are loading a Program, all the samples already loaded will be cancelled and replaced:

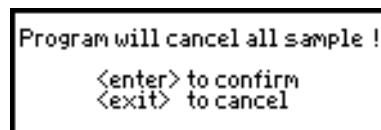

The following steps refer to the loading of a Program.

5. Press ENTER to confirm. If the Program has more than one Level, you must select the one to be loaded:

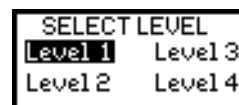

6. Select the Level with the DIAL and press ENTER to load. Loading the Program may take some time, and during the operation the display will show the name of the Samples that are being loaded:

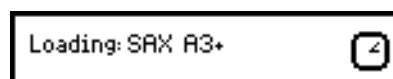

7. At the end of the conversion, the Waveform will contain the first 16 Samples of the Level selected, all assigned to the keyboard ranges defined by the Akai Program and correctly pitched:

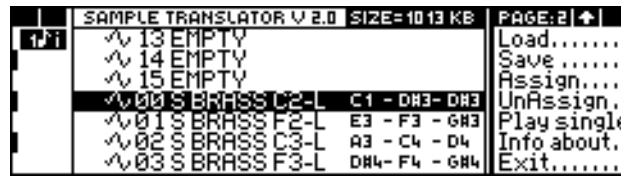

Empty Levels Levels without Samples are recognized by Sample Translator as being empty and indicated, therefore, by a bar and cannot be selected.

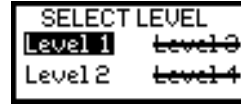

Some Akai Programs may contain Levels that contain no samples, but nevertheless are shown as present, and are therefore recognized by Sample Translator as capable of being loaded. In these cases, Sample Translator will start loading procedures, but will not insert samples into the Waveform.

“Cut End”

The Cut End option appears on the second page of Waveform.



The “loop” of a sample has a starting point (“Loop Start”) and an end point (“Loop End”). When a Sample is loaded from Sample Translator, the part that is used by the Waveform is the one that runs from the start of the Sample (“Sample Start”) to the end of the loop (“Loop End”).

As the part of the Sample that follows the “Loop End” is not played, it is advisable to save space by not loading it into memory. The Cut End function can be activated before carrying out a loading operation. All samples loaded with the Cut End option selected will be loaded without the part that follows the “Loop End”.



Assigning samples to a keyboard range (“Assign”)

A sample has note extension limits beyond which it cannot play. Acoustic instruments have similar limitations, and are unable to play above or below a certain note.

When a Sample is loaded, it can play across its full extension. Until it is assigned to a specific keyboard area, it will play (alone) over this range.



You can listen to the sample to help you decide in what keyboard area you can obtain the best results.

Use the Assign command to define the keyboard range to which the selected sample will be assigned. Once the Assign operation has been carried out, the sample will play together with the other samples assigned to the keyboard range:



Only assigned samples become a part of the Waveform. The overall size of the assigned samples (and consequently the size of the Waveform) is shown on the top line of Waveform:

SIZE=105 KB

1. Select the Assign command from the Waveform display. The range defining window appears:

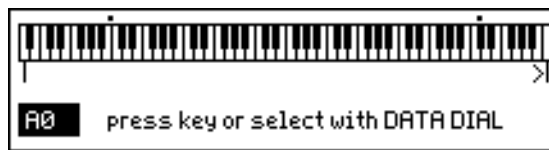

2. Play the lower limit-note and press ENTER to confirm. Play the upper limit-note and press ENTER to confirm. Keyboard range limits can also be set with DIAL+ENTER. In Waveform, the keyboard range is shown next to the sample name (notes C1 and D#3 in the example); the note in the middle (D#3 in the example) represents the original pitch of the sample:



The keyboard range to which a sample is assigned cannot overlap the range of another sample.

After being assigned, the sample played on the keyboard will be shown by a small square that appears next to its name*:

* This symbol appears only if you are playing from the keyboard (Local) or from Common.



Cancelling assignments (“UnAssign”)

The Unassign command cancels the keyboard extension limits to which a sample is assigned. After this command, the sample will play only if it is selected, and a new assign procedure must be carried out to insert the sample into the Waveform again.

Re-assigning limits after an Unassign command

After the assignment of a sample to a keyboard range has been cancelled, the note limits of a new assignment will be those of the previous one. In this case, it is usually sufficient to press ENTER twice, without carrying out further assign operations.

“Play Single” display

The “Play Single” command gives access to a display where you can:

- listen to the individual samples already assigned to a keyboard range (these can also be heard in Waveform, but only together with the other samples assigned to the keyboard range);
- display the waveform of the sample;
- send the sample to an external MIDI device (sampler, computer with editor).

From the Waveform display, select the sample from which to enter “Play Single”, and select the Play Single command:



The sample will play over its original range, without the limits set by the Assign command.

The image that appears on the display is the graphic representation of the sample. This shows the entire sample from the “Sample Start” point to the “Sample End” point. The horizontal axis represents the duration of the sound, and the vertical axis its intensity.

The letters “S” and “E” that may appear over the image show the “Loop Start” and “Loop End” points. These can be programmed from the Info About display (explained in the next section).

“Zoom”

This function allows you to examine a section of the sample in fine detail.

1. Select the Zoom command.
2. An intermittent vertical line will appear on the display, showing the start of the section to be examined. Move the line with the DIAL, and press ENTER to confirm the position:

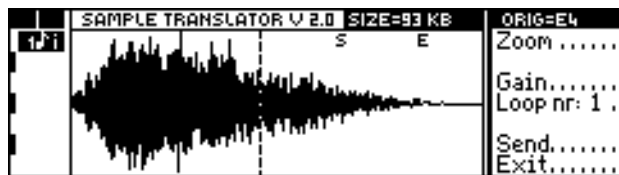

3. A second intermittent vertical line will now appear, showing the end of the zoom section. Move the line with the DIAL, and press ENTER to confirm the final zoom position:

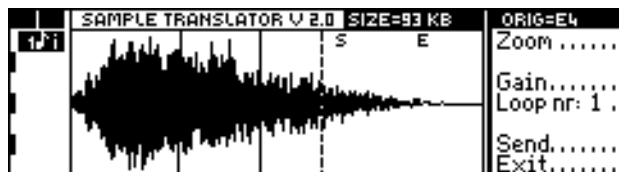

4. The display will show a “close-up” of the section selected:

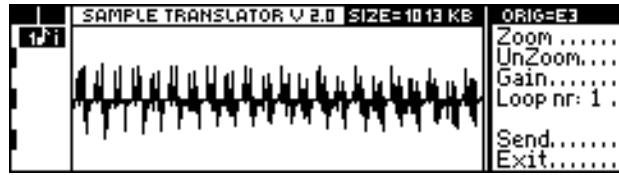

Return to full vision of the sample with the UnZoom command.

“Gain”

This allows you to modify the volume of the sample with respect to the other samples of the Waveform. Select Gain. A small window appears on the display where you can insert the relative volume of the sample. The volume is expressed as a percentage of the maximum volume possible:

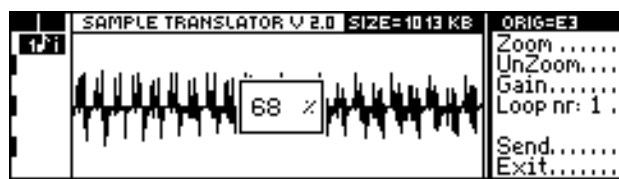

Insert the desired value with the DIAL or the **numeric keypad**, and confirm with ENTER. You will have to wait for a few seconds while the new sample volume is being calculated:

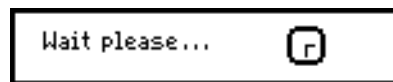

The **undo** button can be used to revert to the original volume setting and back to the modified volume, so that you can compare results.

“Loop nr:(x)”

This command allows you to display the “Loop Start” and “Loop End” points of the eight loops that can be received, for example, with an Akai sample.

Although the S Series can use only the first loop of a sample, Sample Translator can also modify the “Start” and “End” points of the other loops (from the Info About display). These changes can be used by a sampler to which the sample can be sent with the Send command.

“Send”

The sample can be sent to a sampler or a computer. Check that these connections have been made:

- The Music Processor’s MIDI OUT 1 socket to the MIDI IN socket of external device;
- The Music Processor’s MIDI IN 1 socket to the MIDI OUT socket of external device.

Prepare the external device for sample reception. Program channel 1 as the reception channel. Press Send to transmit the sample:

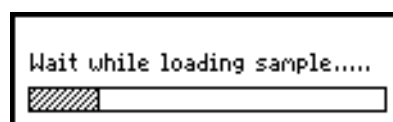

Transmission errors If the connections have not been made correctly or if the external device is unable to receive the sample in MMA_sds format, the following error message will appear:



Check the connections. If no fault is discovered, check the reception channel of the external device (the Music Processor transmits on channel 1).

It is also possible that the external device is unable to recognize the Music Processor's transmit message. In this case, return to the Waveform display and send a Dump Request message from the external device, followed by the number of the sample to be received (0~15).

“Exit”

This returns you to the Waveform display.

The “Info about” display

The “Info about” display allows you to modify these sample parameters:

- original sample pitch;
- definition of “Loop Start” and “Loop End” points;
- definition of loop type.

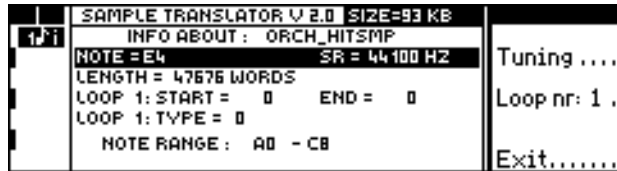

“Note”

Shows the original pitch of the sample. This information is not always received when a sample is loaded, so it can often be necessary to define the correct pitch setting after loading. To help you with this operation, use the Tuning function, which plays notes with the exact Music Processor pitch. (Tuning plays a sinusoidal that is superimposed on the sample).

“Note Link” The Note and SR parameters can be linked while Note is being modified. When Note edit is accessed, the Note Link option will appear, and if this is selected, it will modify SR at the same time as Note:

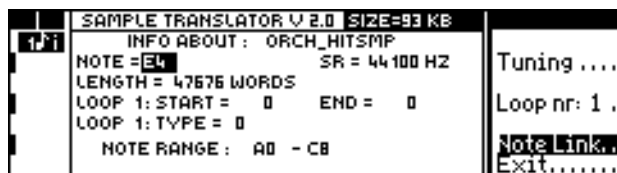

“SR”

“SR” stands for “*Sampling Rate*” - *the frequency with which the Sample is read*. If the Sampling Rate is modified, the sample pitch is also proportionally modified. For example, if the “SR” value is raised, the sample pitch will also become higher.

Basically, this function provides a fine tuning for the sample, avoiding dissonance between the samples that make up the Waveform.

“Length” (cannot be modified)

Length of the sample in *words*. In this case, *word* is the measuring unit of the sample. Since the S Series uses a 16-bit sampling technique, a word is composed of 16 bits (corresponding to 2 bytes).

Therefore, to calculate the length of the sample in bytes, multiply the number shown on the display by 2*.

**Use the following table as a guide.*

1 word	=	2 byte
--------	---	--------

1024 byte	=	1 kbyte
-----------	---	---------

1024 kbyte	=	1 Mbyte
------------	---	---------

“Loop Start” & “Loop End”

These parameters modify the “Loop Start” and “Loop End” points. Any one of the eight loops of the sample can be selected by pressing the “Loop nr:(x)” command the required number of times.

The S Series uses only the first loop, but Sample Translator can also modify the other loops, acting as an editor for samplers.

Access your changes with the **ENTER**, and insert the desired value with the **DIAL** or the **numeric keypad**. The value inserted will be expressed in *words*.

The “Start” and “End” points must lie within the limits of the sample. The maximum value that can be given to “Loop End”, therefore, coincides with the length of the sample. For example, if the “Length” parameter indicates a value of 40000, the maximum value that can be given to “Loop End” is 40000.

Why the loop limits should be modified The loop very often produces a troublesome “click” every time the cycle is repeated. This is caused by the difference created between the end of one loop cycle and the beginning of the next one:



The extreme points of the loop should be modified so that the amplitude at the “Start” point” is matched as precisely as possible to the amplitude at the “End” point, so that the “click” can be heard only very faintly or disappears entirely.

When the loop extremes are modified, you should bear in mind that a loop which gives excellent results, for example, in the central part of the keyboard, can be unsatisfactory in other extensions. This is yet another reason why the multi-sampling technique should be used.

Deactivating Detune With some samples, changes made to the “Start Loop” point cause Detune to be deactivated:



The Detune parameter will still be shown in the Waveset editor, but it will act as Fine Pitch.

These Sounds cannot be converted in SO or DO:



“Loop Type”

This parameter allows you to change the loop type. Even though S Series uses only the first loop, the others can be modified for use with a sampler. Select one of the eight loops by pressing the “Loop nr:(x)” command the required number of times.

Type 0: “Loop Off”. The loop is not played, and therefore the sample has no sustain phase, and will terminate rapidly. This type of loop is used in percussive samples that fade out very quickly.

Type 1: The loop is played only in a forwards direction, as in this example:



Type 2: The loop is played forwards and backwards again, as shown by this diagram:



Although this loop type is not used by the S Series, it can be transmitted to samplers or other sample editors.

“Note range” (cannot be modified)

This shows the keyboard range to which the sample has been assigned. As the keyboard can play all assigned samples when you are in the Info About display, if the sample whose parameters are being modified is played, a line will appear beneath this range of notes*:

* The line appears only if you are playing from the keyboard (Local) or from Common.

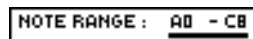

If the sample has not yet been assigned, an “Unassigned” message will appear in place of these notes.

Commands in the right-hand column

- Tuning:** Provides a reference for the sample pitch, producing the exact note played on the S2/S3 (or master keyboard) with a sinusoidal.
- Loop nr.:(x):** Allows you to select one of the eight loops of the sample. Only the first loop is used by the Music Processor, but the others can be modified so that the sample can be sent to an external sampler.
- Note Link:** (Appears only if the Note parameter is modified.) This links the SR parameter to the Note parameter, modifying both at the same time.
- Exit:** Returns to the Waveform display.

Cancelling a sample (“Delete”)

The Delete command, located on the second page of Waveform, cancels the sample selected.

1. Use DIAL to select the sample for deletion.
2. Select the Delete command and press ENTER to confirm the deletion (or EXIT to annul it).

Copying a sample to a different location (“Copy & Paste”)

A selected sample can be copied to a clipboard with the Copy command on the second page of Waveform.

*Note:
Copying a sample does not occupy memory space. The sample copied is never actually ‘duplicated’. The Copy operations make SampleTranslator read the same sample two or more times, in different locations and with specific parameters.*



As soon as the sample is copied, the Paste command will appear in the command/option column. Select a location into which the sample can be copied:

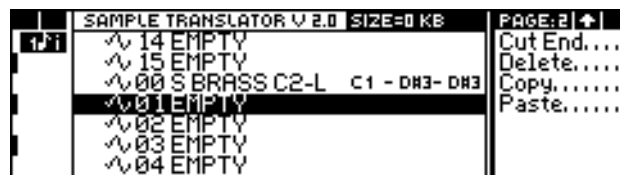

Press Paste to insert the sample into the new location:

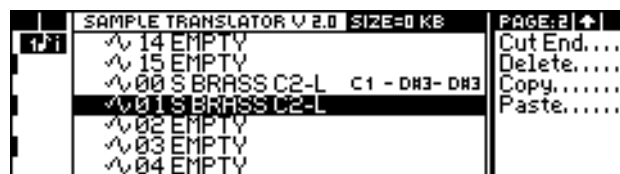

The “pasted” sample can be any sample of the Waveform. After the Copy & Paste operation, range limits must be given to the new sample.

Saving a Waveform (“Save”)

The Waveform created with Sample Translator must be saved as a standard S Series RAM-Waveform. In the Waveform, all the samples assigned to a keyboard range are saved (unassigned samples are lost).

**Note:
Avoid giving two different Waveforms of your sound library the same name. The “Import” function of the Sound Library checks that the Waveform of the Sound you are importing from a floppy disk is not already present in memory. If the name of the Waveform is the same as that of a Waveform already present in memory, the Sound will be loaded without its Waveform, which will be replaced by the Waveform already in memory. As a result, if the two Waveforms are different despite their common name, the characteristics of the Sound will be drastically altered.*

1. Select the Save command on the first page of Waveform. A space will appear where you can insert the name of the Waveform and of a new Sound that uses it:



2. Assign a name of maximum 8 characters to the Waveform*. The **alphanumeric keypad** inserts characters, and the **DIAL** moves the cursor forwards or back. **INSERT** inserts a space at the cursor position, **DELETE** cancels the character in the cursor position, and **CAPITALS** allows you to use capital letters. Confirm the Waveform name with **ENTER**.



3. A new Sound must be created. Give the Sound a name and press **ENTER** to confirm (or **EXIT** to return to SampleTranslator):



4. Assign a Program Change or a Bank Change to the new Sound (in the usual X-Y form). Use the **numeric keypad** or the **DIAL**, in the same way that you select a Sound. Press **Enter** to confirm**.

It is advisable to save the new Sound in a Family of Sounds to which it is similar (or related). For example, if the new Sound is called “FatStrings”, it would best be saved in the “Ensemble” Family.

As soon as the new Sound has been memorized, it should be saved on the disk to avoid losing it when the instrument is switched off.

The Waveform can also be used by other Sounds, by selecting it in Edit Sound-Waveform.

***Note:
It is not possible to give the new Waveform the name of a Waveform already present in memory. If you entered SampleTranslator with a Waveform contained in a RAM-Sound, the original Waveform will not be modified. A new name must be inserted.*

Escape from Sample Translator

To escape from Sample Translator, select the Exit command on the first page of the Waveform display. If a Waveform has been created, Sample Translator asks if you want to lose or save it:

```
Sound not saved. Erase all?  
<enter> to confirm  
<exit> to cancel
```

If you press **ENTER**, the Waveform will be lost. If you do not want to lose the programmed Waveform, press **EXIT** to remain in Sample Translator and select the Save command to save the Waveform.

REFERENCE GUIDE

- SOURCE buttons
- TRACK TRANSPOSER / MASTER TRANSPOSER
- EDIT PERFORMANCE/CONTROLS
- EDIT PERFORMANCE/TRACKS
- EDIT SOUND
- SAMPLE TRANSLATOR
- EDIT SOUND PATCH
- SEQUENCER & SONG
 - The Sequencer controls
 - Recording a Song
- EDIT SONG
- EDIT GENERAL
- DISK
- SOUND LIBRARY
- EFFECTS LIBRARIES
- CLIPBOARD
- UTILITY
 - Bank/Song and Performance name
 - Delete Bank/Song, Clipboard & Performance
 - Copy Bank/Song & Performance
- PRELOAD

1 THE SOURCE section

The buttons in the Source section

The Performance tracks have a different configuration for each Source. For example, while LOCAL Source is set to *layer*, the MIDI IN and SONG Sources can be set to *multi*.

The main display shows the track configuration relating to the currently active Source (shown by the button with the led ON in the SOURCE section).

The track column displays the configuration of the tracks for the selected Source. The symbols which show the status of the Source (♫, x, -) may change according to the Source selected, while the symbols which show the status of the Destinations (i, e) are the same in all the displays.

Local Source

This Source is represented by the integrated keyboard of the instrument, or by the master keyboard (or another MIDI controlling device) connected via MIDI-COMMON.

The possible track playing modes The option/command column shows the following four options to choose from.

SINGLE The keyboard or the master keyboard (connected via MIDI-COMMON) can play only one track. When you select *single* mode from another mode, only the selected track will remain active. You can scroll the tracks with the TRACK SCROLL BUTTONS (the tracks are automatically selected and ready to use).

LAYER The keyboard or the master keyboard (connected via MIDI-COMMON) can play two superimposed tracks. When you select *layer* mode from another mode, the selected track and the next track will remain active. You can scroll the tracks with the TRACK SCROLL BUTTONS (the tracks are automatically selected and ready to use).

SPLIT The keyboard or the master keyboard (connected via MIDI-COMMON) can play two tracks which share the keyboard extension. The track with the lowest number plays the lower part of the keyboard. For example, if you split tracks 1 and 2, track 1 plays on the lower part of the keyboard. When you select *split* mode from another mode, the selected track and the next track will remain active. You can scroll the tracks with the TRACK SCROLL BUTTONS (the tracks are automatically selected and ready to use).

If you select this mode, another option (SET SPLIT) appears in the option/command column which allows you to set the split point on the keyboard. *

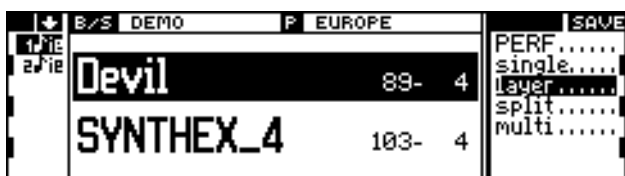

Default display: LOCAL Source example

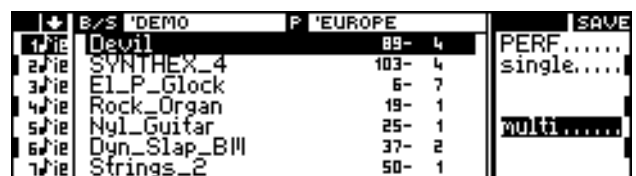

Default display: MIDI IN Source example

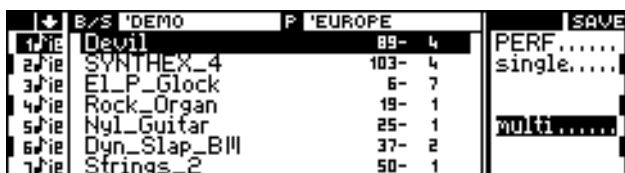

Default display: SONG Source example

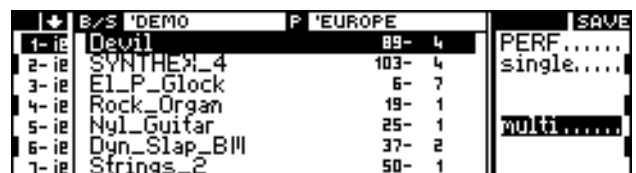

Default display: OPTION Source example

MULTI The keyboard or the master keyboard (connected via MIDI-COMMON) can play up to sixteen tracks which can coexist over the entire keyboard extension or share the extension and the dynamic zones (s. EDIT Performance/Tracks, page 3).

The number of tracks that the keyboard will actually play depends (a) on the number of tracks memorised in the Performance, (b) on the number of tracks set to play (♩).

Track column symbols

The status of each track is indicated by the symbols which appear in the track column.

♩ The track is in "play" mode, in other words it will play when you play on the keyboard or the master keyboard. To place the track on "mute", select the track (if it has not already been selected) and press the corresponding TRACK SELECT KEY again.

X the track is in "mute" mode. To set the track to "play", select the track (if it has not already been selected) and press the corresponding TRACK SELECT KEY again.

– The track is disconnected from the LOCAL Source. Full instructions on how to connect the track to the Source are provided in the chapter on EDIT Performance/Tracks, on page 1.

i The track is connected to the GENERATION Destination (internal sound generation). Full instructions on how to disconnect the track from this Destination are provided in the chapter on EDIT Performance/Tracks, on page 1.

e The track is connected to the MIDI OUT Destination. Full instructions on how to disconnect the track from this Destination are provided in EDIT Performance/Tracks, on page 1.

* The Set split command

1. Select SET SPLIT. The split set window appears on the display:



2. Play the note which corresponds to the upper limit of the first track. Or, rotate the Dial to move the split indicator.

Note: The split point can be set on the master keyboard only if it is connected via MIDI-COMMON.

3. Press ENTER to confirm. The split set window closes.

Midi in Source

This Source is represented by the MIDI instruments connected to the MIDI IN of the Music Processor (not via MIDI-COMMON). E.g. the tracks of an external sequencer.

The possible track playing modes

The option/command column shows the following two options to choose from.

SINGLE The instrument—or computer—connected to the MIDI IN (not MIDI-COMMON) can play only one track. When you select *single* mode from another mode, only the selected track will remain active.

You can scroll the tracks with the TRACK SCROLL BUTTONS (the tracks are selected automatically and are ready to play).

MULTI The instrument—or the computer—connected to MIDI IN (not MIDI-COMMON) can play up to sixteen separate tracks, completely independent and not limited by the current keyboard extension.

The number of tracks the keyboard will actually play depends (a) on the number of tracks memorised in the Performance, (b) on the number of tracks set to "play" (♩).

Track column symbols

The status of each track is indicated by the symbols which appear in the track column.

♩ The track is in "play" mode, in other words it will play when a messages is received via MIDI IN. To place the track in "mute" mode, select the track (if it has not already been selected) and press the corresponding TRACK SELECT KEY again.

X The track is in "mute" mode. To place the track in "play" mode, select the track (if it has not already been selected) and press the TRACK SELECT KEY again.

– The track is disconnected from the MIDI IN Source. For instructions on how to connect the track to Source see. EDIT Performance/Tracks on page 1.

i The track is connected to the GENERATION Destination (internal sound generation). To disconnect the track from this Destination see. EDIT Performance/Tracks on page 1.

e The track is connected to the MIDI OUT Destination. To disconnect the track from this Destination see. EDIT Performance/Tracks on page 1.

Note: The MIDI data from the MIDI IN Source can be transmitted to MIDI OUT only if MIDI-MERGE is active (see. General—Midi).

Song Source

This Source corresponds to the Song in the selected Bank/Song.

The possible track playing modes The option/command column shows the following two options to choose from.

SINGLE Plays back only one track of the Song. When you select *single* mode from another mode, only the selected track will remain active. You can scroll the tracks with the TRACK SCROLL BUTTONS (the tracks are selected and are ready to playback). You can also scroll the tracks to check which ones have been re-recorded).

MULTI Plays back all the tracks recorded and activated to play (in other words the tracks in play mode, shown with the symbol ♪).

Track column symbols The status of each track is indicated by the symbols which appear in the track column.

♪ The Song track contains recorded notes and is in “play” mode. To “mute” the track, select it (if it has not already been selected) and press the corresponding TRACK SELECT KEY.

X The track is in “mute” mode. To place the track in “play” mode, select the track (if it has not already been selected) and press the corresponding TRACK SELECT KEY again.

– The Song track does not contain recorded notes. It can be recorded as a new track.

i The track is connected to the GENERATION Destination (internal sound generation). To disconnect the track from this Destination see EDIT Performance/Tracks on page 1.

e The track is connected to the MIDI OUT Destination. To disconnect the track from this Destination see EDIT Performance/Tracks on page 1.

Track in “record” mode When you enter “record” mode by pressing RECORD, the SONG Source is automatically shown on the display (and the corresponding button in the Source section is selected). Once you have selected the tracks you wish to record, the symbol R (=record) appears in the track status column. See. EDIT Song.

Option Source

This Source is represented by new functions implemented by a User Program. The symbols and track configurations depend on the User Program.

THE SOLO BUTTON

The SOLO button isolates the currently selected track and temporarily deactivates all the remaining tracks of all the Sources. If the currently selected track is in “mute” mode, it is momentarily reactivated by the SOLO function.

The led on the button flashes until you press the button again to deactivate “solo”.

A track set in “solo” may not play in one of the following cases:

- for LOCAL Source, the track may be set beyond the split range or out of the dynamic range;
- for the MIDI IN Source, the track may not receive events via MIDI;
- for the SONG Source, there may be no notes recorded in the track.

2 TRACK TRANSPOSER / MASTER TRANSPOSER

The tracks can be individually transposed in the EDIT TRACK TRANSPOSER environment (figure 1). They can be globally transposed (the instrument as a whole) by means of the MASTER TRANSPOSER button (only S2/S3) or in the “Master Transpose” window of the EDIT TRACK TRANSPOSER environment (figure 2).

All modifications effected with the Track Transposer are shown in EDIT PERFORMANCE/TRACKS, page 2. They can be saved in the Performance.

The TRACK TRANSPOSER button

Track Transposer

Follow this procedure:

1. Select the track to transpose in the track column.
2. Rotate the DIAL or specify the required transpose value with the NUMERIC KEYPAD.

Each transposition unit represents one semitone.

Default: 0. Value range: -60 ... +60.

Octave up	Transpose one octave up.
Octave down	Transpose one octave down.
Master	Opens the Master Transposer window.
Reset	Resets all the track transpose values to zero. This command does not affect the Master Transpose setting.

Master Transposer

Access this editor in the TRACK TRANSPOSER.

1. ACCESS the TRACK TRANSPOSER.
2. Select the “Master” command.

Regulate the Master Transpose setting in the following manner:

1. Rotate the DIAL or specify the required transpose value with the NUMERIC KEYPAD .
2. Press ENTER to confirm and to escape from the window (or press EXIT to annul the command and escape).

Default: 0. Value range: -24 ... +24 semitone.

In S2/S3, the value of Master shown in the window or in the first line of the Track Transposer relates to the MASTER TRANSPOSE buttons.

The MASTER TRANSPOSE buttons (only S2/S3)

These buttons are identified by the silk-screened symbols representing “sharp” (#) and “flat” (b). When pressed repeatedly, they decrease or increase the global pitch of the instrument by one semitone at a time.

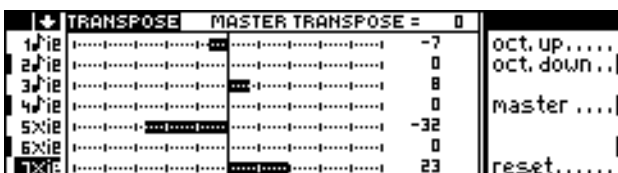

Figure 1: Track Transposer

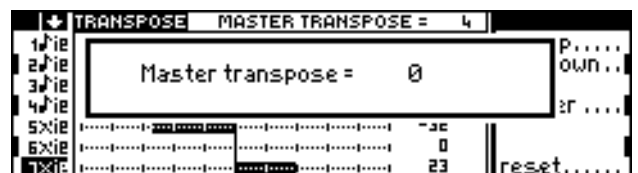

Figure 2: Master Transpose

If a negative transposition is active (pitch lowered), the led on the flat button is shown ON. Conversely, if a positive transposition is active (pitch increased), the led on the sharp button is shown ON.

To restore the standard pitch of the instrument, you can press the deactivated button repeatedly until the led on the active button goes off, or you can regulate the setting in the “Master Transpose” window of the EDIT TRACK TRANSPOSER environment.

The setting effected with the MASTER TRANSPOSE buttons is reflected in the Master Transpose value shown in the Track Transposer display.

3 EDIT PERFORMANCE/CONTROLS

The modifications made to a Performance must be stored in memory with [SAVE PERFORMANCE]. The Performance stored in memory must be saved to Ram-disk or floppy disk for future use.

All the operations performed in EDIT SOUND can be annulled with UNDO before carrying out another task.

The EDIT PERFORMANCE/CONTROLS environment is where you can programme the general parameters of the Performance. A Performance can memorise: the two effects assigned to the DSPs, the maximum Pitch Bend excursion, the effect of the Wheels and Pedals and how the Function Controllers operate.

With these settings, changing a Performance reconfigures the instrument automatically, rendering it immediately available to modify a live playing situation or the track situation for a Song recording task.

You can create a new Performance by saving an existing Performance to a new Performance slot (Procedure: [SAVE PERFORMANCE] [SELECT THE BANK] [SELECT THE PERFORMANCE]).

Page 1: Effects

Effect 1	Reverb assigned to DSP 1. If you select a reverb in Effects Library 1, this parameter will be modified automatically. Value range: see table in the Appendix.
Effect 1 Volume	Determines the total volume of the signal effected by the DSP 1. The higher the value assigned to this parameter, the more evident the effect will be.
Effect 2	Determines the type of Modulation assigned to DSP 2 such as Echo, Chorus, Flanger, Fladel, Panmix, Phaser, Ensemble, Panecho, Dubbing. If you select a modulation in Effects Library 2, this parameter will be modified automatically. Value range: see table in the Appendix.
Effect 2 Volume	Determines the total volume of the signal effected by the DSP 2. The higher the value assigned to this parameter, the more evident the effect will be.

Page 2: Controllers (S2/S3)

Pitch Bend Sensitivity	Maximum Pitch Bend excursion, in semitones. Value range: -12 ... +12.
Pedal/Footswitch 1	Multiple parameter: selects the type of pedal (<i>pedal</i> or <i>footswitch</i>) and assigns the MIDI message it can generate. <i>Note:</i> The footswitch polarity can be defined in EDIT GENERAL. Value range: see table at the end of the chapter.
Pedal/Footswitch 2	As above.

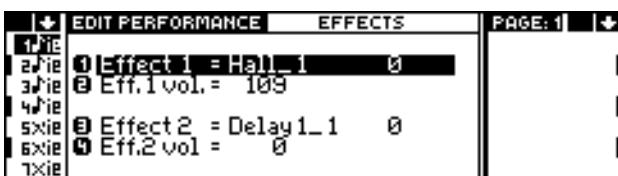

Page 1: Effects

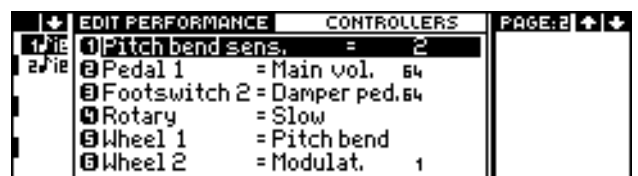

Page 2: Controllers (S2/S3)



Page 3: User Keys (S2/S3)

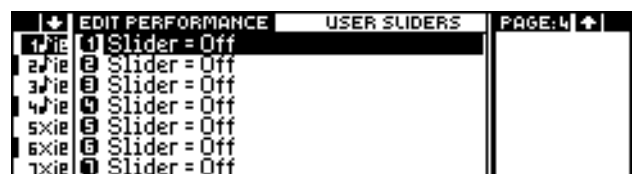

Page 4: User Sliders (S2/S3)

Rotary	Initial velocity of Rotary modulation. When the DSP receives the MIDI Control Change 90 message, the Rotary velocity passes gradually from <i>slow</i> to <i>fast</i> or vice versa. Value range: Slow or Fast.
Wheel 1	MIDI message generated by Wheel 1 (left). Wheel 1 is spring loaded and returns automatically to its central position after use, and it is therefore advisable to assign parameters with neutral values at the centre (Pitch Bend, Pan). Value range: see table at the end of the chapter.
Wheel 2	MIDI message generated by Wheel 2 (right). Wheel 2 is not spring loaded but is centred for quick recognition of the central position. Value range: see table at the end of the chapter.

Page 3: User Keys (S2/S3)

Keys 1 ... 7	Function assigned to the buttons in the FUNCTION CONTROLLERS section when the led on the USER/PANEL button is ON. Value range: see table at the end of the chapter.
V	Value assigned to the function when the User Key is pressed. The Control Change messages 64 ... 79 cannot be controlled by these keys.
T	The Track activated by the User Key. This parameter appears only for MIDI channel messages (Program Change, Volume, Pan, Damper...).

Page 4: User Controllers (S2/S3)

Sliders 1 ... 7	The function assigned to the cursors of the FUNCTION CONTROLLERS when the led on the USER/PANEL button is ON. Value range: see table at the end of the chapter.
-----------------	--

Page 2: Controllers (S2R)

Pitch Bend Sensitivity	Maximum Pitch Bend excursion in semitones (for messages received via MIDI). Value range: -12 ... +12.
Footswitch 1	MIDI message generated by Footswitch 1. <i>Note:</i> The footswitch polarity can be set in EDIT General. Value range: see table at the end of the chapter.
Footswitch 2	As described above.
Rotary	Initial velocity of the Rotary modulation. When the DSP receives the MIDI Control Change 90 message, the Rotary velocity passes gradually from <i>slow</i> to <i>fast</i> or vice versa. Value range: Slow or Fast.

Page 3: Function Controller (S2R)

The Function Controller page shows a series of horizontal bars which can be modified with the DIAL, each corresponding to one of the tracks displayed. The bars represent the value of the parameter selected in the option column.

Parameters	Volume, Attack, Release, Filter 1, Filter 2, Pan.
F.C. Reset	Resets the Attack, Release, Filter 1 and Filter 2 values to their default settings.

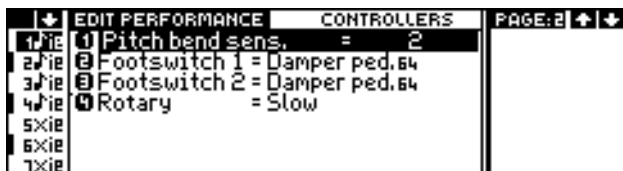

Page 2: Controllers (S2R)



Page 3: Function Controller (S2R)

Assignable MIDI messages

Only the messages shown in reverse highlight affect the sound generation of the S Series. The notes shown in brackets [] indicate a special implementation of the message in the S Series. The messages indentified with an asterisk (*) are transmitted to the MIDI OUT on the Common Channel and not on the channel assigned to the track.

Footswitch

- Rotary s/f* (trasm. Cntrl 90)**
- (01) Modulation**
- (08) Balance [Osc 1/2]**
- (64) Damper**
- (65) Portamento
- (66) Sostenuto**
- (67) Soft Pedal**
- (68) Control 68
- (69) Hold 2
- (70 ... 79) Controls 70 ... 79

Pedals, Wheels, User Sliders

- | | | |
|--|-------------------------------|----------------------------------|
| Prop. Volume (trasm. Cntrl 07) | (04) Foot Controller | (14) [Filter 1 Cutoff] |
| Pitch Bend | (05) Portamento Time | (15) [Filter 2 Cutoff] |
| Pitch + | (06) Data Entry | (16) Gen. purp. control. 1 |
| Pitch - | (07) Main Volume | (17) Gen. purp. control. 2 |
| Eff 1 Volume* (trasm. Cntrl 21) | (08) Balance [Osc 1/2] | (18) Gen. purp. control. 3 |
| Eff 2 Volume* (trasm. Cntrl 22) | (09) Control 9 | (19) Gen. purp. control. 4 |
| (00) Control 0 / BankSelect | (10) Panorama | (20) [Filters 1+2 Cutoff] |
| (01) Modulation | (11) Expression | (21 ... 31) Controls 21 ... 31 |
| (02) Breath | (12) [Attack] | |
| (03) Control 3 | (13) [Release] | |

User Keys

- | | | | |
|--------------------------------------|-------------------------------|----------------------------------|--------------------------------|
| Effect 1* (trasm. Cntrl 21) | (05) Portamento Time | (14) [Filter 1 Cutoff] | (65) Portamento |
| Effect 2* (trasm. Cntrl 22) | (06) Data Entry | (15) [Filter 2 Cutoff] | (66) Sostenuto |
| Rotary s/f* (trasm. Cntrl 90) | (07) Main Volume | (16) Gen. purp. control. 1 | (67) Soft Pedal |
| Program Change | (08) Balance [Osc 1/2] | (17) Gen. purp. control. 2 | (68) Control 68 |
| (00) Control 0 / BankSelect | (09) Control 9 | (18) Gen. purp. control. 3 | (69) Hold 2 |
| (01) Modulation | (10) Panorama | (19) Gen. purp. control. 4 | (70 ... 79) Controls 70 ... 79 |
| (02) Breath | (11) Expression | (20) [Filters 1+2 Cutoff] | |
| (03) Control 3 | (12) [Attack] | (21 ... 31) Controls 21 ... 31 | |
| (04) Foot Controller | (13) [Release] | (64) Damper | |

4 EDIT PERFORMANCE/TRACKS

The modifications made to a Performance must be stored in memory with [SAVE PERFORMANCE].

The Performance stored in memory must be saved to Ram-disk or floppy disk for future use.

All the operations performed in EDIT SOUND can be annulled with UNDO before carrying out another task.

The EDIT PERFORMANCE/TRACKS section allows you to individually and independently edit each track of a Performance. For each track you can define; the Sources and Destinations, the MIDI IN and MIDI OUT channels, the mixer parameters such as Volume and Transpose, the activation of controls such as the Wheel, Pedal, Aftertouch, the extension and dynamic limits, the activation of the Effects, the Audio Outputs and Pan assignments and the activation of the MIDI Filters.

All editing tasks are carried out on the selected track. You can also select a different track in this environment using the TRACK SELECT KEYS and TRACK SCROLL BUTTONS as used in normal situations.

By combining the Performance tracks, complex orchestrations can be achieved. For example, keyboard extension limits allows you to split the keyboard into several different zones, each with a different sound (multisplit situations). Dynamic limitations allow you to create sounds with a dynamic threshold which trigger a different timbre according to how hard a note is played (e.g. a Pick Bass with low dynamic value and a Slap Bass with high dynamic value).

Editing the effects and the Audio Outputs allows you to configure the Performance for studio recording or to ensure proper mixing of the tracks.

You can edit a completely new Performance with default settings using the “Create” command in the command/column.

General commands

Create Creates a track or all the tracks with default settings. If you select an existing track its parameters are reset to default values (GrandPiano, Volume 127, Transpose 0, Source and Destination connected).
Value range: 1 ... 16, All.

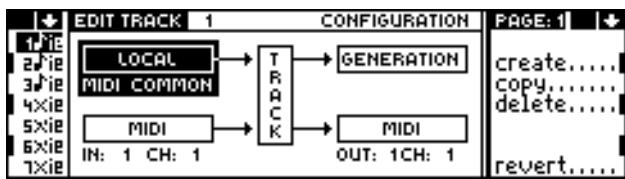

Page 1: Configuration

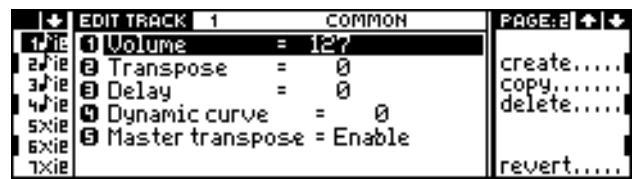

Page 2: Common

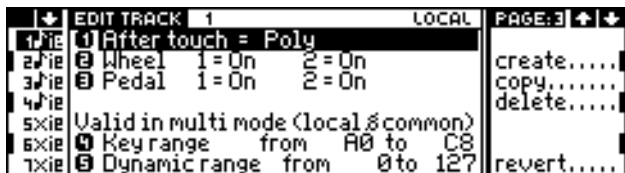

Page 3: Local (S2/S3)

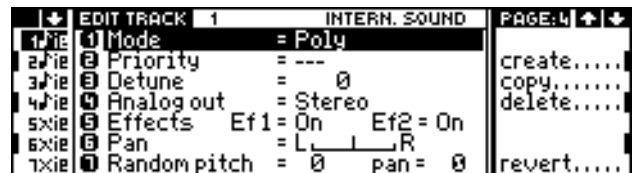

Page 4: Internal Sound

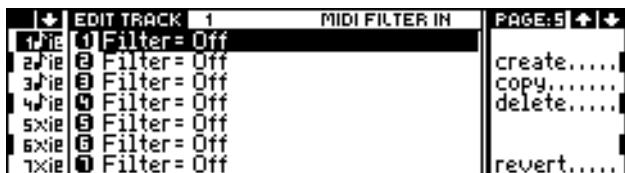

Page 5: Midi Filter In

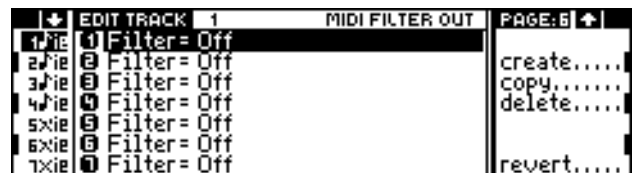

Page 6: Midi Filter Out

1. Press Create. The following dialogue window will appear:

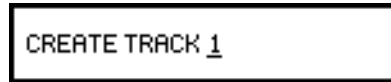

2. Enter the track number you wish to create (1 ... 16). The option "All" appears after the number 16. "All" creates all the tracks (resetting the values of the existing tracks to default settings).

Copy

Copies the selected track to another track or to all the tracks.
Value range: 1 ... 16, All.

1. Press Copy. The following dialogue window will appear:

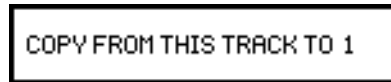

2. Enter the track number to copy (1 ... 16). The option "All" appears after the number 16. "All" copies to all the tracks.

Delete

Cancels the selected track, removing it from the track column.

Note: It is not possible to cancel a track of a Performance that is exploited by a Song present in the current Bank/Song.



Hint: Use this command to cancel tracks which are not used in the Performance. If you erroneously cancel a track you can undo the operation with "Revert".

Revert

Cancels the last "Create", "Copy" or "Delete" operation carried out.

Page 1: Configuration

Page editors

The Configuration page shows four *icons*, which are graphic representations of the complex parameters. Each icon represents one of the four Sources LOCAL/MIDI-COMMON and MIDI IN and the Destinations GENERATION and MIDI OUT. The icons can be selected by rotating the DIAL. To gain access to the icon's incorporated text parameters, simply select the required icon and tap on ENTER. To escape an icon edit, tap on ENTER or press EXIT once.



LOCAL/MIDI-COMMON Source. When the arrow is shown the track is connected to the keyboard or to the controlling device connected to the Midi-Common (master keyboard, guitar controller, Midi accordion...).

Select the icon and press ENTER to disconnect or connect the Source.



MIDI IN Source. When the arrow is shown the track is connected to the Midi In (non MIDI-COMMON channels). Select the icon and press ENTER to connect or disconnect the Source and to access the text parameters IN and CH.

IN MIDI IN port to which the track is connected. Select the icon with the DIAL and press ENTER to access this parameter:

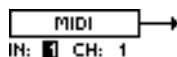

Enter the number of the MIDI IN port (1 or 2). Press ENTER to pass on to the next parameter.

CH MIDI IN channel assigned to the track. You can enter this parameter either from the previous parameter, or by selecting the icon and pressing ENTER twice.

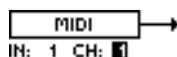

Enter the number of the MIDI IN channel. Press ENTER to confirm the setting of the MIDI IN Source and return to the icon selection mode.



GENERATION Destination. When the arrow is shown the track is connected to the internal sound generator. Select the icon and press ENTER to connect or disconnect the Destination. The connection of this Destination is shown in the track column by the letter "i". If "i" is not displayed, this Destination is disconnected from the track.



MIDI OUT Destination. When the arrow is shown the track is connected to the MIDI OUT (non MIDI-COMMON channels). Select the icon and press ENTER to connect or disconnect the Destination and to access the text parameters OUT and CH.

OUT MIDI OUT port to which the track is connected. Select the icon with the DIAL and press ENTER to access this parameter:

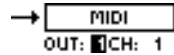

Enter the number of the MIDI Out port (1 or 2). Press ENTER to pass on to the next parameter.

CH MIDI Out channel assigned to the track. You can access this parameter from the previous one or by selecting the icon and pressing ENTER twice.

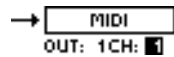

Enter the number of the MIDI Out channel. Press ENTER to confirm the setting of the MIDI Out Destination and return to the icon selection mode.

Hint: If you want to direct data received at MIDI IN to the MIDI out destination together with Midi data generated by the Music Processor, you must activate the MIDI MERGE function in the EDIT GENERAL section.

Page 2: Common

Parameters common to GENERATION and to the MIDI OUT.

Volume

The Track volume. Allows you to mix the Performance tracks. This parameter affects the internal sound generation and is transmitted from MIDI OUT. It corresponds to the adjustments made with the Function Controllers (S2R: in the "Function Controller" page).

Value range: 0 ... 127.

Transpose

Transposes the track. Allows you to increase or decrease the track pitch in semitone steps. This parameter affects the internal sound generation and is transmitted from MIDI OUT. It corresponds to the editing carried out in TRACK TRANSPOSER environment.

Value range: -60 ... +60 (semitones).

Delay

This parameter delays the transmission of the message to the Destinations. Allows you to delay the production of the sound with respect to the action of playing on the keyboard. The delay value is indicated in 1/192nds of a quarter note (crotchet) and it is synchronised with the Sequencer Clock (the corresponding musical note appears together with the parameter value).

Value range: 0 ... 192 (q) ... 384 (h) ... 576 (h.) ... 768 (w).

Dynamic curve

Dynamic response curves. Each curve represents a different way in which the Sound intensity responds to changes in keyboard velocity. Curves 0 to 3 provide increasing degrees of sensitivity of the Sound to velocity changes. Curves 4 to 7 provide inverse effects.

Value range: 0 ... 7.

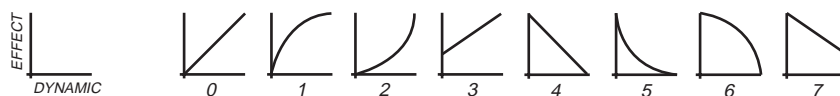

Hint: By programming two tracks with opposing dynamic curves, you can create *cross-fade* effects between the two tracks.

Master Transpose Enables/disables the Master Transpose function. Tracks disabled for Transpose are automatically tuned to play the "Equal Intonation Scale" (s.). Disable Master Transpose for the drumkit track to prevent the drum configuration from being altered.
Value range: Enable/Disable (---).

Page 3: Local (S2/S3)

Parameter for the "local" controls (keyboard and controllers) and for the MIDI-COMMON.

Aftertouch Activates/deactivates the Aftertouch for the track. Aftertouch is the pressure applied to the note while you hold it down. Aftertouch can affect both the track and the corresponding MIDI channel (Channel or Mono) or affect only the note which is pressed (Poly).
Note: When "Aftertouch" is disabled, Aftertouch messages received at MIDI IN (non MIDI-COMMON channels) will continue to affect the notes played.
Value range: Off (---), Channel/Poly.

Wheel 1 Activates/deactivates Wheel 1 (left) for the track.
Value range: On/Off (---).

Wheel 2 Activates/deactivates Wheel 2 (right) for the track.
Value range: On/Off (---).

Pedal 1 Activates/deactivates Pedal/Footswitch 1 for the track.
Value range: On/Off (---).

Pedal 2 Activates/deactivates Pedal/Footswitch 2 for the track.
Value range: On/Off (---).

Valid only in multi mode (local & common)

The following two parameters affect the tracks of a Performance only when it is set to MULTI MODE and only for the LOCAL/MIDI-COMMON Source.

Key range The keyboard extension across which the track can play. This is a useful setting to create Performances with different sounds assigned to different sections of the keyboard (e.g. Acoustic Bass at the lower end, GrandPiano at the centre and Flute at the higher).
1. Select the parameter. A keyboard with a horizontal bar will appear on the display showing the current track extension:

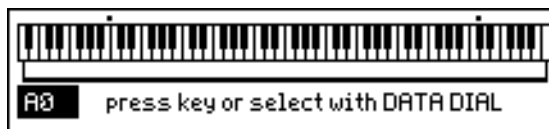

2. Select the lowest note by pressing a note on the keyboard or by rotating the DIAL.

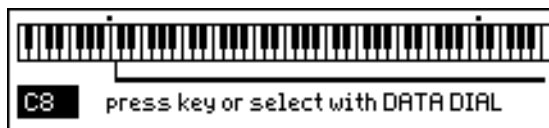

3. Press ENTER to pass to the next note limit. Select the highest note by pressing the note on the keyboard or rotating the DIAL.
4. Press ENTER to confirm the Key Range or EXIT to escape.

Dynamic range Dynamic range of the track. Above and below these limits the track will not play. If the limits fall between 0 and 127 the track will always play.

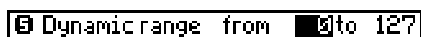

Value range: 0 ... 127 - 0 ... 127.

Hint: By programming two tracks with adjacent Dynamic ranges (e.g. 0-112 and 113-127) you can create *cross-switch* combinations without using the Sound Patches (s.).

Page 3: Local (S2R)

Parameters valid for LOCAL/MIDI-COMMON.

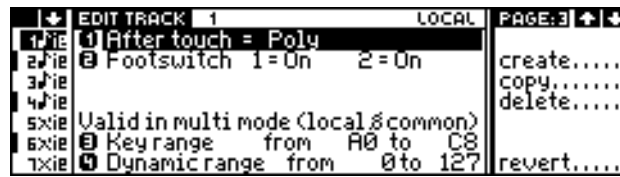

Page 3: Local (S2R)

Aftertouch Activates/deactivates the Aftertouch for the track. Aftertouch is the pressure applied to the note while you hold it down. Aftertouch can affect both the track and the corresponding MIDI channel (*Channel* or *Mono Touch*) or affect only the note which is pressed (*Poly Touch*).

Note: "Aftertouch" affects messages originating from MIDI-COMMON. Even when Off, Aftertouch messages originating from the other MIDI IN channels (not MIDI-COMMON) will affect the notes played.

Value range: Off (---), Channel/Poly.

Footswitch 1 & 2 Activates/deactivates Footswitches 1 and 2 for the track.

Value range: On/Off (---).

Valid only in multi mode (local & common)

The following two parameters affect the tracks of a Performance only when it is set to multi mode and only for the LOCAL/MIDI-COMMON Source.

Key range The keyboard extension across which the track can play. This is a useful setting to create Performances with different sounds assigned to different sections of the keyboard (e.g. Acoustic Bass in the bass section, GrandPiano at the centre and Flute in the higher section).

1. Select the parameter. A keyboard with a horizontal bar will appear on the display showing the current track extension:

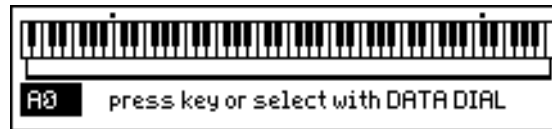

2. Select the lowest note by pressing a note on the keyboard or by rotating the DIAL.

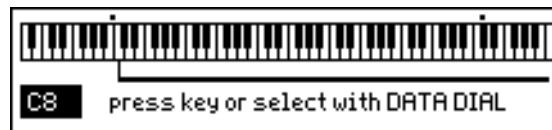

3. Press ENTER to pass to the next note limit. Select the highest note by pressing the note on the keyboard (only if connected via Midi-Common) or by rotating the DIAL.
4. Press ENTER to confirm the Key Range or EXIT to escape.

Dynamic range Dynamic range of the track. Above and below these limits the track will not play. Between 0 and 127 the track will always play.

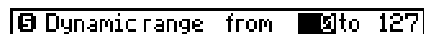

Value range: 0 ... 127 - 0 ... 127.

Hint: By programming two tracks with adjacent Dynamic Ranges (e.g. 0-112 and 113-127) you can create *cross-switch* combinations without using the Sound Patches (s).

Page 4: Internal Sound

Mode	<p>Selects the polyphonic/monophonic mode of the track. A track is said to be <i>polyphonic</i> when it plays more than one note simultaneously and <i>monophonic</i> when it plays one note only (regardless of how many notes are pressed simultaneously - typical of many synthesizers produced in the 70's).</p> <p>A monophonic track excludes all the notes but one of a chord played on the keyboard; when you play a chord, only the highest note (<i>mono right</i>) or the lowest (<i>mono left</i>) will play.</p> <p><i>Note:</i> Sound Patches and Drumkits are always in <i>poly</i> mode.</p> <p>Value range: Poly/Mono left/Mono right.</p>
Priority	<p>Assigns a "special Polyphonic status" to a track in multi-timbral situations to prevent "note stealing". The term "note stealing" describes what occurs when the total number of notes played exceed the maximum permitted polyphony: in such cases, one or more notes are freely "eliminated" to maintain the instruments maximum permitted polyphony. By assigning Priority to a Track, it will be protected from "note stealing" and the freely eliminated notes will be lost elsewhere.</p> <p>Value range: On/Off (---).</p> <div style="background-color: #f0f0f0; padding: 5px; border: 1px solid #ccc;"> <p>Hint: Enable Priority on tracks dedicated to the drumkit, the bass line, the melody line and the more important backings. Do not enable Priority for too many tracks since this will render the function inactive.</p> </div>
Detune	<p>Fine tunes any Sound assigned to the track, in steps of 1/64th semitone.</p> <p>Value range: -64 ... +64.</p>
Analog out	<p>Audio outputs. The track can be directed to any of the audio outputs (STEREO OUTPUTS LEFT/RIGHT, 1, 2, 3, 4). The combinations possible are as follows.</p> <hr/> <p>STEREO LEFT/RIGHT The sound is "effected" by the internal DSPs (wet). It is routed to the LEFT and RIGHT outputs, balanced by the Pan programmed for the track.</p> <hr/> <p>OUT 1+2 The sound has no effects (dry), overriding the internal DSPs. It is routed to outputs 1 and 2, balanced by the Pan programmed for the track.</p> <hr/> <p>OUT 3+4 The sound has no effects (dry), overriding the internal DSPs. It is routed to outputs 3 and 4, balanced by the Pan programmed for the track.</p> <hr/> <p>1, 2, 3, 4 The sound has no effects (dry). These are mono outputs and are not affected by Pan modifications.</p>
Effects	<p>Activates/deactivates the two DSPs for the track. Eff 1 is the reverb processor, Eff 2 is the modulation processor (delay, chorus...).</p> <p>The effects assigned to the two DSPs and their overall level are shown in EDIT PERFORMANCE/CONTROLS (s.).</p>
Pan	<p>= <i>Panorama</i>, position of the sound in the stereophonic "panorama". It affects sound generation and is sent to the MIDI OUT. Pan has no effect on the acoustic signal of the tracks which escape from the single audio outputs (1, 2, 3, 4).</p> <p>This parameter must be controlled while you are playing by means of the Function Controllers (S2R: see page on Function Controller).</p> <p>Value range: L U L L R (-31, all left) ... L U L L R (0, centre) ... L U L L R (+31, all right).</p>
Random pitch	<p>Creates slight pitch variations freely and is useful for simulating the pitch instability typical of instruments such as bells or some types of ethnic instruments.</p> <p>Value range: 0 (Off), 1 ... 7.</p>
Random pan	<p>Creates Pan variations freely (position of the sound in the stereophonic panorama).</p> <p>Value range: 0 (Off), 1 ... 7.</p>

Page 5: MIDI Filter In

Filter 1 ... 7	<p>MIDI IN filters. It is possible to filter, or exclude, from any track (not MIDI-COMMON), up to seven MIDI messages from the incoming MIDI DATA STREAM. The Filter is active when the name of a MIDI message appears in place of the word "Off". The messages which can be filtered are listed in the table at the end of the chapter.</p>
----------------	--

Hint: If you are controlling the Music Processor with an instrument which does not conform to General MIDI standards, it is advisable to filter the Program Change messages from each track, because the same Program Change numbers will very probably correspond to different sounds on the two instruments.
Select the sounds of the Music Processor manually.

Page 6: MIDI Filter Out

Filter 1 ... 7

MIDI OUT filters. It is possible to filter, or exclude, from any track (not MIDI-COMMON), up to seven MIDI messages from the outgoing MIDI DATA STREAM. The Filter is active when the name of a MIDI message appears in place of the word "Off". The messages which can be filtered are listed in the table at the end of the chapter.

Hint: If you are controlling an instrument which does not conform to General Music standards with the Music Processor, it is advisable to filter the Program Change messages from each track, because the same Program Change numbers will very probably correspond to different sounds on the two instruments.
Select the sounds of the instrument controlled by the Music Processor manually.

MIDI messages assignable to the Midi Filters (In & Out)

Only the messages shown in reverse highlight affect the sound generation of the S Series. The notes shown in brackets [] indicate a special implementation of the S Series message.

ProgramChange	(11) Expression	(68) Control 68	(98) Non-Reg.Par.Num.(LSB)
Pitch Bend	(12) [Attack]	(69) Hold 2	(99) Non-Reg.Par.Num.(MSB)
Mono Touch	(13) [Release]	(70 ... 79) Controls 70 ... 79	(100) Reg.Par.Num. (LSB)
Poly Touch	(14) [Filter 1 Cutoff]	(80) Gen. purp. control. 5	(101) Reg.Par.Num. (MSB)
(00) Control 0 / BankSelect	(15) [Filter 2 Cutoff]	(81) Gen. purp. control. 6	(102...120) Controls 102...120
(01) Modulation	(16) Gen. purp. control. 1	(82) Gen. purp. control. 7	(121) Reset control
(02) Breath	(17) Gen. purp. control. 2	(83) Gen. purp. control. 8	(122) Local control
(03) Control 3	(18) Gen. purp. control. 3	(84 ... 90) Controls 84 ... 90	(123) All Note off
(04) Foot Controller	(19) Gen. purp. control. 4	(91) External Effect Depth	(124) Omni Mode off
(05) Portamento Time	(20) [Filters 1+2 Cutoff]	(92) Tremolo Depth	(125) Omni on
(06) Data Entry	(21 ... 31) Controls 21 ... 31	(93) Chorus Depth	(126) Mono Mode on
(07) Main Volume	(64) Damper	(94) Celeste Depth / Detune	(127) Poly Mode on
(08) Balance [Osc 1/2]	(65) Portamento	(95) Phaser Depth	
(09) Control 9	(66) Sostenuto	(96) Data increment	
(10) Panorama	(67) Soft Pedal	(97) Data decrement	

Note: The Control Changes numbered 21 ... 24 and 90 are generally used by the S Series to control the DSPs. These messages must be transmitted via the MIDI-COMMON which is not, however, affected by the MIDI Filters. Consequently the chapter dedicated to the MIDI Filters does not describe the function of these messages in the case of the S Series.

Notes and suggestions

Delete Track If you cannot cancel a track from a Performance because the same track is exploited by the Song in the same Bank/Song, use the following “trick”:

1. Save the Performance to another Bank/Song.
2. Cancel the track.
3. Save the modified Performance back to the original Bank/Song.

Delay You can combine different tracks with different delay values to create complex repeating effects. An example of this application is heard in the ROM-Performance “Modern Gnome”.

Aftertouch Aftertouch can be simultaneously activated in some tracks and deactivated in others. An example of this application is a Performance in layer mode with Piano and Strings assigned to the two tracks. By activating Aftertouch for just the Strings track you can change the Volume of this sound by pressing the notes on the keyboard, while Piano (whose track has Aftertouch deactivated) will not be changed.

MIDI Filter The MIDI OUT Filters can be very useful when combined with MIDI MERGE. Consider, for example, a MIDI setup with a sequencer connected to the MIDI IN of the Music Processor and an expander connected to its MIDI OUT:

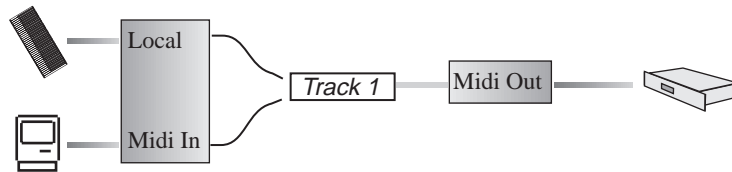

The MIDI MERGE is active. The sequencer transmits Program Changes to track 1 to select the Sound. The Program Change transmitted to track 1 selects both the Sound of the Music Processor (GENERATION Destination) and a sound for the expander (MIDI OUT Destination). The expander sound may not correspond to that of the Music Processor and may not be suitable, therefore, you should assign the ProgramChange message to one of the MIDI Out Filters. Consequently, the Sound of the Music Processor will be selected, while the filter excludes the Program Change message from the MIDI OUT.

5 EDIT SOUND

All the EDIT SOUND operations can be cancelled by pressing the UNDO button before carrying out other operations.

The elements which make up a Sound can be modified in the EDIT SOUND environment. Press the **SOUND** button to activate the edit of the sound assigned to the currently selected track. Here you can edit the basic sample, the volume, the amplitude envelope, the LFO, the filters and respective envelope, pitch variations over time and Pan.

EDIT SOUND also incorporates the SAMPLE TRANSLATOR with which you can read samples from Ms-Dos/Atari or Akai S1000 disks, and receive or transmit samples via Midi and create new Waveforms.

Single Oscillator (SO), Dual Oscillator (DO), Dual Crossfade (DC) Sounds

Sounds are produced by generators known as *oscillators*. The S Series oscillators can be combined in three different ways to produce three types of Sounds: Single Oscillator Sounds (SO), Dual Oscillator Sounds (DO) and Dual Crossfade Sounds (DC).

The Sound type can be selected in the WAVESET editor (s.). It is also possible to convert the Sounds from one type to another.

Sound types

Single Oscillator (SO) Only one oscillator is exploited to read a single Waveform. Sounds of this type are 32-voice polyphonic due to the individual exploitation of the instrument's 32 oscillators.



Dual Oscillator (DO) Two oscillators are exploited to read two different Waveforms. A Sound is composed of two different fundamental sounds. By using two oscillators per voice, the maximum polyphony permitted by these sounds is 16 voices.

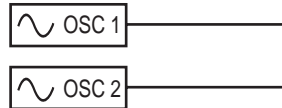

Dual Crossfade (DC) Two oscillators are exploited to read a single Waveform. The reading process is a very efficient method (*Crossfade, Multiwave Looping*) which provides high quality results. The use of two oscillators per voice permits a maximum polyphony of 16 voices.

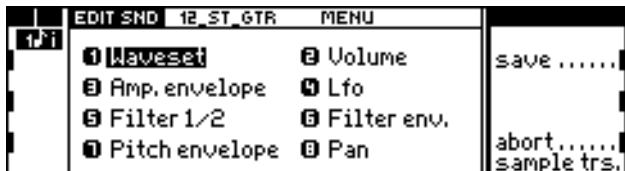
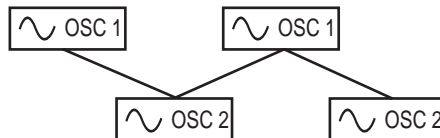

Figure 1: Main menu (DC and DO Sounds)



Figure 2: Main menu (DC and DO Sounds)

Polyphony obtained with different types of sounds

The maximum permitted polyphony of the Music Processor depends (1) on the current track playing mode and (2) on the type of Sounds assigned to the tracks.

Maximum polyphony obtainable in the various track playing modes

Note: The Sound Patches and Drumkits behave as the DC Sounds.

single	With an SO Sound, the polyphony is 32 notes. With a DO or DC Sound polyphony is 16 notes.
layer	With two SO Sounds, the polyphony is 16 notes. With two DO or DC Sounds the polyphony is 8 notes. With one SO Sound and one DC or DO Sound you can obtain approximately 24-note polyphony.
split	With two SO Sounds, the polyphony is 32 notes. With DO and DC Sounds polyphony is 16 notes. With one SO sound and one DC or DO Sound, you can obtain approximately 24-note polyphony.
multi	The polyphony depends on the complexity of the configuration. With only SO Sounds, a minimum polyphony of approximately 24 notes is guaranteed.

Access the EDIT SOUND environment

Access to the EDIT SOUND environment is via the same method for all Sound types:

1. Select the Sound (track) you wish to edit from the main display.
2. Press the **Sound** button (the main EDIT SOUND menu is displayed).

Different displays will appear according to the type of Sound selected (*figures 1, 2*). The first difference lies between the Sound and the Sound Patch/Drumkits. The second difference lies in the access to the edit with an SO Sound or with a DO or DC Sound.

The edit environment (the editors of the edit sound menu)

The elements that make up the EDIT SOUND environment are grouped in different *editors*, listed in the *main menu* (*figures 1 and 2*).

The editors of the edit sound menu

Waveset	Selects the Waveform (fundamental waveform or waveforms of the Sound).
Volume	Volume of the Sound.
Amplitude envelope	Varies the volume over time, defined by two graphic representations consisting of ten segments each: Key On Envelope and Key Off Envelope.
LFO	Modulation. Can be tied to the Sequencer Clock. Generates cyclic variations in the amplitude or in the cutoff frequency of the filters.
Filter 1/2	Filters 1 and 2. Modify the timbric quality of the Sound, attenuating or enhancing certain frequencies, such as in an equalizer.
Filter envelope	(Not present in the case of SO Sounds, s.). Variation of the Filter's effect over time.
Pitch envelope	Variation of the Pitch over time.
Pan	Position of the Sound within the Stereophonic panorama. In DC and DO Sounds it is also possible to programme the Pan envelope.

The options of the main menu and of the editors

The options of the main menu

Save	Allows you to save the modified or created Sound to the Sound Library.
Abort	Cancels. Escapes from the edit without saving the modifications or the created Sound.
Sample Translator	Activates the program which acquires and edits the Sample Translator samples (s.).

The editor options (secondary menus)

Menu	Escapes from the editor and returns to the main EDIT SOUND menu.
Compare	<p>Momentarily recalls the original version of the Sound currently in edit, in order to compare the two versions. The display also shows the parameter status of the original Sound. While you are in "Compare" mode, the following two commands will appear in the command/option column:</p>
	<p>copy Copies the displayed parameter status relating to the original Sound to the page of the Sound in edit, and escapes from "Compare" mode.</p>
	<p>comp./exit Escapes from "Compare" without effecting any changes or loss of edit data.</p>
Special options	Each editor and page shows options specific to the page.

Status of the instrument in edit sound mode

When you enter the EDIT SOUND environment, the instrument is set to "solo" status automatically (the led on the **Solo** button flashes) - this is to isolate the Sound in edit from the rest of the tracks. You can exclude "solo" (by pressing SOLO button - led OFF) in order to listen to the Sound currently in edit together with all the tracks of the Performance. This will give you an idea of what your edited Sound is like when combined with other Sounds. Press "solo" again to re-isolate the Sound and continue with the edit tasks.

The settings of the Wheel, Pedal, Aftertouch, Transpose and the other parameters of the Performance are those of the currently selected Performance.

In EDIT SOUND mode you can play back a Song, but any changes of Performance will be ignored.

Temporary escape from edit sound

Thanks to multitasking, you can temporarily escape EDIT SOUND mode by pressing SOUND, NORMAL, or the button of another operating section. The Sound remains in edit, but the selected track plays the original Sound. To return to the sound in edit press SOUND.

The **Sound** button will flash while the Sound is in edit mode.

If you escape EDIT SOUND mode without making changes to the Sound, the led on the **Sound** button goes off.

Escaping from edit sound and saving the modified sound

Once you have completed your editing tasks, you can save the new or modified Sound in the Sound Library (s.).

1. Select "Save" from the main sound edit menu. The SOUND LIBRARY will appear. This is where all the instrument's Sounds are stored in order of Program Change

number and Family. The name of the Sound to memorise is shown in a small window:



* If you have modified a Ram-Sound, you can save the modified Sound to the same location you started from.

2. Select an empty location where the Sound* can be memorised. The selected location is defined by a Program Change number and a Bank Select number, messages with which the Sound can be recalled via Midi or from the control panel. Select the location using one of the following procedures:

- go to the Family to which the Sound belongs with the MULTIFUNCTION KEYS, then rotate the DIAL to select the location within the Family;
- specify the Program Change and Bank Select numbers on the NUMERIC KEYPAD as if you were selecting the Sound from the control panel (form xxx-yyy).

3. If necessary, select “Name” to change the Sound’s name:



Insert: inserts a space at the cursor position. *Capitals:* inserts capital letters. *Delete:* cancels a character at the cursor position. ENTER to confirm, EXIT to cancel.

4. Select “Store” to memorise the Sound to the selected location.

Note: The Sound is saved to the Sound Library resident in memory; remember that when you turn off the instrument, the edited Sound (and all other edited work) will be irremediably lost. To store your Sound permanently, save the Sound Library to disk or to the Ram-disk. Refer to the chapters dedicated to the SOUND LIBRARY buttons or DISK for further information.

Possible error messages during the Sound save task



The Destination is occupied by another Sound. Solution: repeat the operation and select a different location.



You have given your Sound a name which already exists in the Sound Library. Solution: repeat the operation and assign a different name to the edited Sound.



You can not overwrite a Rom-Sound. Repeat the operation and select an empty location.

Escape from edit sound without memorising the modified sound

If you decide to abandon Sound editing, you can escape from the environment with the “Abort” command in the main menu. If you confirm, the edit environment will close without memorising the modified Sound.

Converting a Sound to a different type

The options required to transform the Sound currently in edit into a Single Oscillator (SO), Dual Oscillator (DO) or Dual Crossfade (DC) type appear in the options column of the Waveset editor:

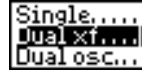

The Sound currently in edit can be converted into either of the two remaining Sound types. Obviously, its characteristics will change quite notably according to which parameters are altered during the conversion.

Conversion limits

Filter envelopes DC and DO Sounds that are converted into the SO type retain the information on their Filter envelopes, but they are not, however, used. Reconverting to DC or DO types, the information is recuperated in its original form.

Waveforms consisting of two different samples When a DC Sound is converted to an SO or DO Sound, the Waveforms consisting of two different samples (e.g. *Vocal_Gtr*, *Strings_Glkn* or *Fantasy*) will lose the second sample. Reconverting to DC mode, the second sample will be restored.

Gain SO Sounds have an output level that is -6 dB lower than DC and DO Sounds. When you convert a Sound to an SO type, you may need to adjust the GAIN parameter in the Filter 1/2 page to balance your levels. Bear in mind that an opposite change may be necessary when returning from SO to DC or DO.

Sample Translator Sample Translator creates DC Sounds that can be subsequently converted. Not all Sounds created with the SAMPLE TRANSLATOR can be converted to SO or DO. This occurs when the amplitude at the Loop Start point is much larger than that of the Sample Start. If you want to be sure of converting the Sounds created with SAMPLE TRANSLATOR into SO Sounds, choose a Loop Start point with an amplitude very similar to that of the Sample Start.



Waveset

The Waveset editor provides access to the principal control parameters of the Waveform, that is, the basic waveform of the Sound.

Waveform (Sound Dual Crossfade)

Waveform	Basic waveform of the Sound. Here you can select one of the 209 Rom Waveforms, or a Waveform loaded in memory with a Ram-Sound, or one created with the SAMPLE TRANSLATOR (Waveforms numbered from 210 onwards). The Waveforms are numbered progressively and can be selected by specifying their number. The list of Rom-Waveforms appears in the Appendix.
Transpose	Transposes the Waveform in semitones. Value range: -64 ... +64.
Detune	Detune creates an equal and opposite pitch offset between two oscillators in steps of 1/64th of a semitone. The pitch of one of the oscillators is increased while the pitch of the other one is decreased. Positive values correspond to an increase of Oscillator 1. When you convert the Sound to an SO type, this parameter is transformed to Fine Pitch, which will probably require an adjustment. Value range: -64 ... +64. <i>Note:</i> With most of the Waveforms, the "Pitch depth" (s.) of the two Oscillators can be separated only if Detune has any value other than 0. In Sounds based on these Waveforms it is possible, for example, to increase the Pitch of Osc.1 while the Pitch of Osc.2 is lowered. When Detune = 0, however, the Pitch Envelope of Osc.2 follows that of Osc.1, regardless of the status of the "Pitch depth ch 2" parameter. At the end of this chapter is a table of the Rom-Waveforms which allow a different programming of the Pitch Envelope even when Detune = 0.
Pitch touch sensitivity	Sensitivity of Pitch to Aftertouch variations. The Pitch of the Sound can be varied by applying pressure on the notes of the keyboard after <i>key on</i> .. Positive values increase the Pitch while negative ones have the inverse effect. Value range: -7 (lowest sensitivity = -2 semitones) ... +7 (highest sensitivity = +2 semitones).

Waveform (Single Oscillator Sound)

Waveform	Basic waveform of the Sound. Here you can select one of the 209 Rom Waveforms, or a Waveform loaded in memory with a Ram-Sound, or one created with the SAMPLE TRANSLATOR (Waveforms numbered from 210 onwards). The Waveforms are numbered progressively and can be selected by specifying their number. The list of Rom-Waveforms appears in the Appendix.
Transpose	Transposes the Waveform in semitones. Value range: -64 ... +64.

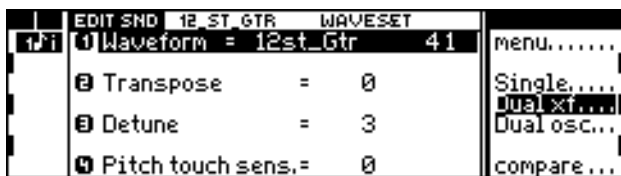

WAVESET editor (Dual Crossfade Sounds, DC)

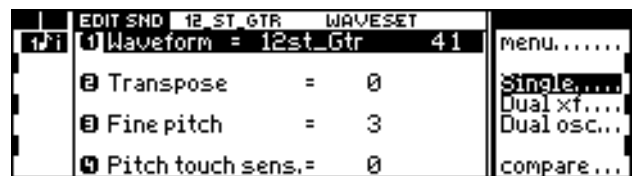

WAVESET editor (Single Oscillator Sounds, SO)

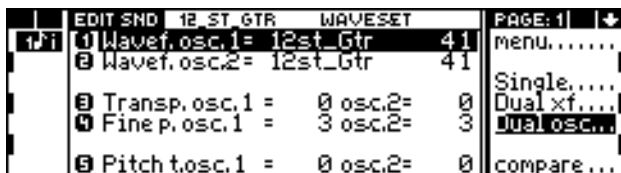

WAVESET editor, Page 1 (Dual Oscillator Sounds, DO)

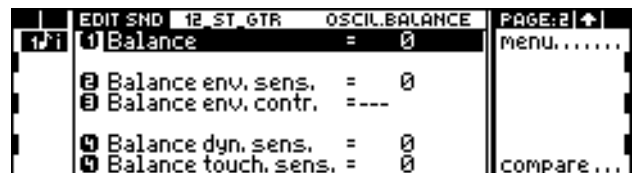



WAVESET editor, Page 2 (Dual Oscillator Sounds, DO)

Fine pitch	Fine pitch of the Waveform in steps of 1/64th of a semitone. Value range: -64 ... +64.
Pitch touch sensitivity	Sensitivity of Pitch to Aftertouch variations. The Pitch of the Sound can be varied by applying pressure on the notes of the keyboard after <i>key on</i> . Positive values increase the Pitch while negative ones have the inverse effect. Value range: -7 (lowest sensitivity = -2 semitones) ... +7 (highest sensitivity = +2 semitones).

Page 1: Waveform (Dual Oscillator Sound)

Waveform osc.1	Basic waveform of the Sound. Here you can select one of the 209 Rom Waveforms, or a Waveform loaded in memory with a Ram-Sound, or one created with the SAMPLE TRANSLATOR (Waveforms numbered from 210 onwards). The Waveforms are numbered progressively and can be selected by specifying their number. The list of Rom-Waveforms appears in the Appendix.
Waveform osc.2	Waveform assigned to Oscillator 2. As above.
Transpose osc. 1/2	Separate transposition (in semitones) for the two Oscillators. Value range: -24 ... +24.
Fine pitch osc. 1/2	Separate Fine pitch (in steps of 1/64th of a semitone) for the two Oscillators. Value range: -64 ... +64.
Pitch touch osc. 1/2	Sensitivity of the Pitch of the two Oscillators to Aftertouch variations. The Pitch of the two oscillators can be varied by applying pressure on the notes of the keyboard after <i>key on</i> . Positive values increase the Pitch while negative ones have the inverse effect. Value range: -7 (lowest sensitivity = -2 semitones) ... +7 (highest sensitivity = +2 semitones).

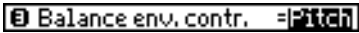
Page 2: Oscillator Balance (Dual Oscillator Sound)

Balance	Mixer for the two Waveforms. Positive values render the first Waveform louder, negative values enhance the second Waveform. This parameter can be controlled through the MIDI Control Change 08 message ("Balance"), assignable to a Pedal, Wheel or User Slider (S2/S3). Value range: -127 ... +127.
Balance envelope sensitivity	Depth of the action of the envelope on Balance. The envelope is activated by the Balance Envelope Control parameter below. Value range: -7 ... +7.
Balance envelope control	Links Balance to the graphic representations of the Pitch or Pan envelope. If dashes are displayed (---) the Balance is fixed and does not follow any form of envelope: <div style="text-align: center;">   </div> <p><i>Note:</i> It is not necessary for the Pan or Pitch envelopes to be active; Balance requires only the graphic form of the envelope.</p>
Balance dynamic sensitivity	Response of Balance to dynamic variations. Positive values enhance the presence of the first Waveform with increased dynamic intensity, negative values enhance the presence of the second Waveform with increased dynamic intensity. Value range: -7 ... +7.
Balance touch sensitivity	Response of Balance to Aftertouch variations. Positive values enhance the presence of the first Waveform with increased Aftertouch pressure, negative values enhance the presence of the second Waveform with increased Aftertouch pressure. Value range: -7 ... +7.

Volume



The Volume editor gains access to the Sound volume controls. The volume programmed on these pages relates to the Sound's basic volume, which interacts with the track and instrument volume settings. In any case, it is the maximum level available of the Sound in any situation.

In the second page you can programme the Volume Tracking, or the variation of the level programmed in the first page across the keyboard. It is sometimes necessary to enhance the presence of a sound more or less across the keyboard in order to simulate to a greater degree that which occurs in reality. For example, an acoustic piano can reach a higher sound level in the bass register, while the higher notes are less intensive.

Page 1: Volume

Volume	Maximum Sound level. Value range: 0 ... 127.
Dynamic sensitivity	Volume response to dynamic variations. Positive values increase the sound's intensity with greater dynamic values, while negative values lower the sound's intensity with increased dynamics. Value range: -7 ... +7.
Volume touch sensitivity	Positive values increase the sound's intensity with increased aftertouch pressure, while negative values gives the inverse effect with increased aftertouch. Value range: -7 ... +7.

Page 2: Volume Tracking

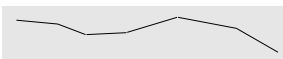
Options	Here you can divide the Tracking curve into several different segments, in order to obtain a more refined Tracking across the keyboard.
	1 segm One Segment. The Tracking curve is essential, representing a constant Volume offset across the keyboard. The parameter "Key" cannot be modified.
	3 segm Three Segments. The Tracking curve consists of 3 segments which allow the construction of a situation offering different variations across the keyboard.
	6 segm Six segments. The Tracking curve is divided into many parts: allowing a more complex programming of the Volume offsets across the keyboard.
Parameters	The three parameters displayed across the bottom parts of the Tracking curve can be accessed by tapping repeatedly on ENTER. The selected parameter can be modified with the DIAL (the "Key" and "Level" parameters also with the NUMERIC KEYPAD).
	point One of the extreme ends of a segment. Rotation of the DIAL selects one of the points of the Tracking curve (1, 2, or 1, 2, 3, 4, or 1, 2, 3, 4, 5, 6, 7).
	key Determines the keyboard position for the point in edit. The extreme points (A#0, C8) cannot be modified.
	level Determines the volume offset (at the selected KEY position) with respect to the Volume parameter programmed in the first page. The parameter value is always negative. Value range: -63 ... 0.

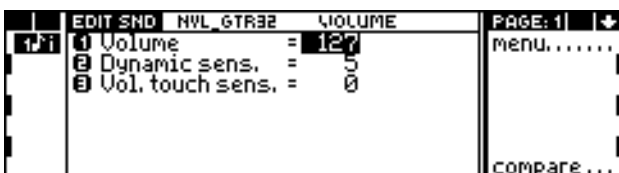

Page 1: Volume

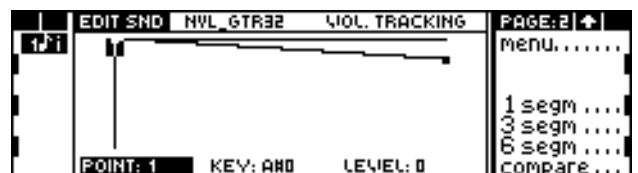

Page 2: Volume tracking

Detailed procedure Carry out the following steps to access and edit the Tracking parameters:

1. Tap ENTER to select one of the parameters “Point”, “Key” (if possible) or “Level”.
2. Rotate the DIAL to select a POINT, to change the KEY note or modify the LEVEL.
3. Press ENTER to pass on to the next parameter. After “Level” you will return to “Point”.

Amplitude envelope

The AMPLITUDE ENVELOPE is the volume displacement of the Sound level over time. The Amplitude Envelope editor allows you to programme the Key On Envelope, the Key Off Envelope and the Envelope Tracking.

The Key On Envelope is a 10 segment curve (maximum) that represents the variation of the sound for the entire duration that the notes are held pressed.

Key Off Envelope is a 10 segment curve (maximum) that represents the variation of the sound after the notes have been released. This envelope phase is often called Release.

In practice, the Key On and Key Off Envelopes correspond to the traditional ADSR parameters (Attack, Decay, Sustain, Release).

The Envelope Tracking controls the keyboard’s effect on the envelope completion velocity (rate) across the keyboard. The Envelope completion (of Key On and Key Off) can be faster or slower across the keyboard of acoustic instruments (e.g. the bass notes of the piano or guitar whose duration is longer than the higher notes).

Page 1: Amplitude Envelope Control

Envelope finish

This parameter determines the note from which the Key Off envelope cannot interrupt the amplitude envelope on its natural course to completion. The Envelope Finish parameter is indispensable to simulate, for example, the piano where no dampers are applied from the note A6 onwards; the sound continues indefinitely after release. When this parameter is not set to “Off”, the last segment of the Key On Envelope sets to 0 automatically (and cannot be modified) to prevent the sound from playing infinitely (owing to the deactivated Key Off Envelope).

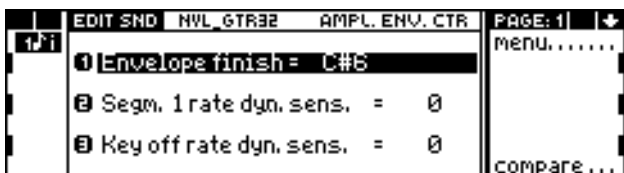

Page 1: Amplitude envelope control

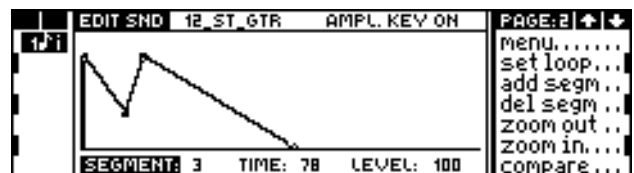

Page 2: Amplitude Key On



Page 3: Amplitude Key Off

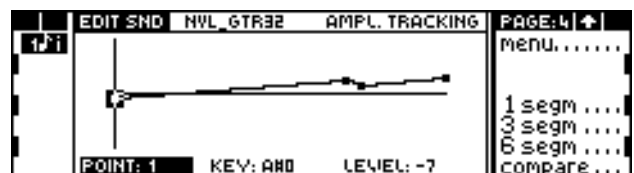

Page 4: Amplitude envelope tracking

Segment 1 rate dynamic sens.	Response of Segment 1 of the Key On Envelope to dynamic variations. Segment 1 corresponds to the Attack phase. This parameter ties the Attack of the Sound to dynamics. Positive values increase the Attack rate with increased dynamics while negative values give the inverse effect with increased dynamics. Value range: -7 ... +7.
Key Off rate dynamic sens.	Response of the Key Off Envelope to the release dynamics. The Key Off Envelope corresponds to the Release phase. This parameter ties the Sound's Release to the velocity with which the notes are released (Note Off Velocity or Dynamic Off). Positive values increase the completion speed of the Key Off Envelope with increased release dynamics, while negative values slow it down with increased release dynamics.

Page 2: Amplitude Key On

Commands

The option/command column shows specific options for this page.

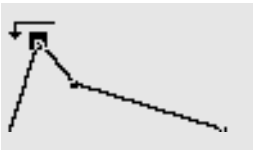

set loop Activates the loop (envelope repetition). Determines the starting point of the envelope repetition. When the envelope reaches its terminal point, it loops back to the beginning. The cycle repeats continuously until you release the keys. The loop is represented by an arrow which indicates the initial loop point.

To eliminate the loop, select its first segment again and then select "Set Loop".

Note: You can programme a loop only if "Envelope finish" parameter (previous page) is set to "Off".

add segm Adds a segment. Inserts a new segment in the envelope curve immediately after the currently selected segment. *N.B.:* a maximum of up to 10 segments is permitted.

del segm Cancels the segment selected. *N.B.:* The Key On Envelope must have at least one segment (corresponding to Attack), which cannot be cancelled.

zoom in Enlarges the field of vision of the envelope up to 4 times.

zoom out Reduces the field of vision of the envelope; it also cancels a *zoom in*. Reduces the envelope up to three times its standard size.

Parameters

Tap **ENTER** to access the three parameters displayed under the Key On Envelope curve. Edit the selected parameter with **DIAL** ("Time" and "Level" also with the **NUMERIC KEYPAD**).

segment One of the envelope segments (1 - 10), whose end point is selected.

time Duration of the Segment. The maximum segment time is approximately 21 seconds.
Value range: 0 ... 127.

level Sound level of the selected segment at its terminal point. The maximum level corresponds to the volume programmed in the Volume editor *N.B.:* the initial level of the first segment is always zero (it cannot be modified).

Value range: 0 ... 127.

Detailed procedure... Follow these steps to access and modify the parameter:

1. Tap **ENTER** to select one of the parameters "Segment", "Time", "Level".
2. Rotate the **DIAL** to select a segment or to modify its duration or level. You can enter a "Time" and "Level" value on the **NUMERIC KEYPAD**.
3. Press **ENTER** to select the next parameter. After "Level" you will return to "Segment".
4. Select "Add segm." to add a new segment after the selected segment. Select "Del. segm." to cancel the selected segment.

Page 3: Amplitude Key Off

Commands	<p>The option/command column shows specific options for this page.</p> <hr/> <p>add segm Adds a segment. Inserts a new segment in the envelope curve immediately after the currently selected segment. <i>N.B.:</i> a maximum of up to 10 segments is permitted.</p> <hr/> <p>del segm Cancels the segment selected. <i>N.B.:</i> The Key Off Envelope must have at least one segment (corresponding to Attack), which cannot be cancelled.</p> <hr/> <p>zoom in. Enlarges the field of vision of the envelope up to 4 times.</p> <hr/> <p>zoom out Reduces the field of vision of the envelope; it also cancels a <i>zoom in</i>. Reduces the envelope up to three times its standard size.</p>
Parameters	<p>Tap ENTER to access the three parameters displayed under the Key Off Envelope curve. Edit the selected parameter with DIAL ("Time" and "Level" also with the NUMERIC KEYPAD).</p> <hr/> <p>segment One of the envelope segments (1 - 10), whose end point is selected.</p> <hr/> <p>time Duration of the Segment. The maximum segment time is approximately 21 seconds. Value range: 0 ... 127.</p> <hr/> <p>level Sound level of the selected segment at its terminal point. The maximum level corresponds to the volume programmed in the Volume editor <i>N.B.:</i> the level at the terminal point of the Key Off Envelope is always zero. Value range: 0 ... 127.</p> <p>Detailed procedure Follow these steps to access and modify the parameters:</p> <ol style="list-style-type: none"> 1. Tap ENTER to select one of the parameters "Segment", "Time", "Level". 2. Rotate the DIAL to select a segment or to modify its duration or level. You can enter a "Time" and "Level" value on the NUMERIC KEYPAD. 3. Press ENTER to select the next parameter. After "Level" you will return to "Segment". 4. Select "Add segm." to add a new segment after the selected segment. Select "Del. segm." to cancel the selected segment.

Page 4: Amplitude Envelope Tracking

Options	<p>These three options permit you to divide the Tracking "curve" into different segments; in order to permit a more or less refined programming of the Tracking across the keyboard.</p> <hr/> <p>1 segm 1 segment. The Tracking is essential and provides a constant variation of the completion velocity of the envelope across the keyboard. The "Key" parameter cannot be modified.</p> <hr/> <p>3 segm 3 segments. The Tracking consists of 3 segments which create a curve with different variations across the keyboard.</p> <hr/> <p>6 segm 6 segments. The Tracking curve is greatly divided, allowing a complex programming of the envelope completion velocity variations across the keyboard.</p>
Parameters	<p>The three parameters displayed across the bottom parts of the Tracking curve can be accessed by tapping repeatedly on ENTER. The selected parameter can be modified with the DIAL (the "Key" and "Level" parameters also with the NUMERIC KEYPAD).</p> <hr/> <p>point One of the extreme ends of a segment. Rotation of the DIAL selects one of the points of the Tracking curve (1, 2, or 1, 2, 3, 4, or 1, 2, 3, 4, 5, 6, 7).</p> <hr/> <p>key Determines the keyboard position for the point in edit. The extreme points (A#0, C8) cannot be modified.</p> <hr/> <p>level The envelope completion velocity offset (Key On and Key Off). Positive values increase the completion velocity, negative values slow it down. 0 corresponds to the "standard" duration of the segments programmed in the previous pages. Value range: -63 ... 0...+63.</p>

Detailed procedure Follow the steps set out below to access and edit the Tracking parameters:

1. Tap **ENTER** to select one of the parameters “Point”, “Key” (if possible), or “Level”.
2. Rotate the **DIAL** to select a **POINT**, to change the **KEY** note or modify the **LEVEL**.
3. Press **ENTER** to pass on to the next parameter. After “Level” you will return to “Point”.

Lfo

LFO or Low Frequency Oscillator is a periodic (repeating) control source. It produces a low speed waveform (low frequency) that can be applied to various aspects of the sound to cause patterns of cyclic change. Because of its periodic nature, the LFO can be used to create effects like Tremolo (cyclic amplitude modulation), Vibrato (cyclic pitch modulation) or, for example, “Wah-wah” (applied to the filter cutoff-frequency).

Lfo

“Midi sync” option MIDI synchronism. When this option is selected, it synchronises the Lfo to the Music Processor’s MIDI Clock, synchronising the Lfo to the Tempo of the Song or of external impulses. (For access to the MIDI Clock, press the **CLOCK** button).

Wave The waveform of the low frequency oscillation. Given the low frequency of the oscillation, the waveform is clearly perceptible. You can choose from the following waves:

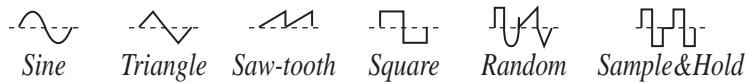

Rate Defines how frequently the LFO repeats. When “MIDI sync” is selected the value shown indicates the musical note that the oscillation corresponds to.
Value range: 1 ... 200 or 1/1 ... 1/128th of a note (w).

Delay Determines the delay before the Lfo appears. Entry of the Lfo becomes gradual.
Value range: 0 ... 64.

Pitch Applies Lfo to the Pitch to produce a Vibrato effect. You can programme both the first and the second part of the multiple parameter, which interact.

Pitch Determines the modulation depth of Lfo on Pitch. Positive and negative values indicate an opposed sense of vibration at the starting phase (upwards or downwards respectively).
Value range: -7 ... +7.

Touch sensitivity Links the depth of the Pitch modulation to Aftertouch. By applying pressure to the keys, the “Delay” parameter is ignored and the oscillation starts immediately.
Value range: 0 ... +7.

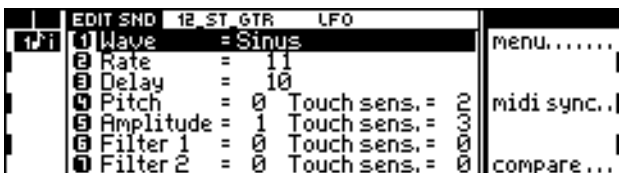

Lfo Editor (Dual Crossfade, DC, and Dual Oscillator Sounds, DO)

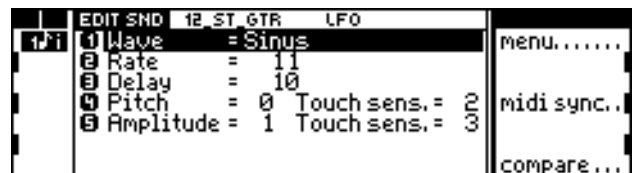

Lfo Editor (Single Oscillator Sounds, SO)

Amplitude

Applies Lfo to the Amplitude to produce Tremolo effects. You can programme both the first and the second parts of this multiple parameter, which interact.

Amplitude Determines the modulation depth of the Lfo on the Amplitude (the output level). The positive and negative values indicate an opposed sense of increase/decrease of the Tremolo output level (the choice between positive or negative values give perfectly equivalent results). Higher positive or negative values increase the modulation depth. Value range: -7 ... +7.

Touch sensitivity Links the depth of the Amplitude modulation to Aftertouch, permitting the control of the amount of Tremolo by varying the pressure applied to the keys. The "Delay" parameter is ignored when pressure is applied to the keys and the oscillation starts immediately. Value range: 0 ... +7.

Filter 1 (DC and DO Sounds)

Applies Lfo to the Cutoff Frequency of Filter 1 to produce a "Wha-Wha" effect (obtained by "opening" and "closing" the Filter). You can programme both the first and the second parts of this multiple parameter, which interact.

Filter 1 Determines the modulation depth of the Lfo on the Cutoff Frequency. The positive and negative values indicate an opposed sense of "opening" and "closing", otherwise, the choice between a positive or negative value give perfectly equivalent results. Higher positive or negative values increase the Filter modulation depth. Value range: -7 ... +7.

Touch sensitivity Links the depth of the Filter modulation to Aftertouch. By applying pressure to the keys, the "Delay" parameter is ignored and the oscillation starts immediately (toggles between open and closed filter). The value 0 is equivalent to no effect and the higher values produce a greater amount of modulation. Value range: 0 ... +7.

Filter 2 (DC and DO Sounds)

As above, but for Filter 2.

Filter 1/2

Filters enhance or attenuate certain frequencies of the Waveform (or the Waveforms). The sound changes according to the type of filter selected ("Type" parameter).

The two filters of the S Series are connected in series, so that Filter 2 operates on the sound already processed by Filter 1. In the case of DO Sounds, the filters have the same effect on both the basic Waveforms.

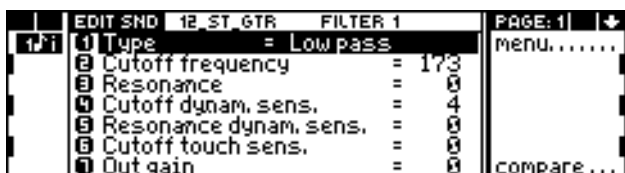

Page 1: Filter 1

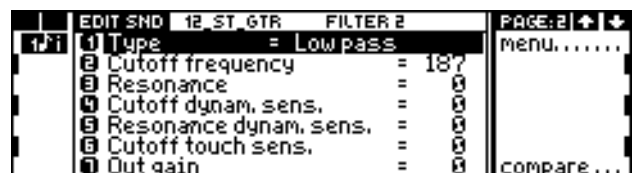

Page 2: Filter 2

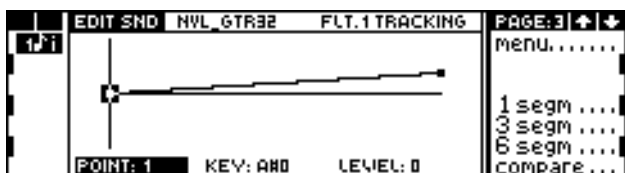

Page 3: Filter 1 tracking

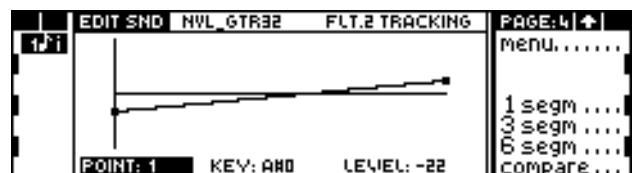

Page 4: Filter 2 tracking

4-pole Filter:
 Programme identical parameter values for the "Filter 1" and "Filter 2" pages in this editor; the "Filter 1 Tracking" and "Filter 2 Tracking" pages in this editor; the Envelope Amount F1 and F2 parameters in the "Filter Envelope Control" page of the next editor (only DC and DO Sounds).

The filters are 2 pole filters with rolloff curves at 12 dB per octave. If both filters are programmed with identical parameter values, they become a single 4 pole filter with a rolloff at 24 dB per octave, perfect for those classic analog synth sounds.

The Filter Tracking parameters, programmed on pages 3 and 4, ensure that the Cutoff Frequency does not remain fixed for all the notes of a Sound, but moves according to the note played. Tracking can prevent, for example, the "cutting" of the higher notes of a Sound which is affected by a Low Pass Filter.

In the case of DC and DO Sounds, the filters have a complex envelope that allows them to vary the quality of the timbre over time. In SO Sounds the envelope is not present. In the former case, the filters are *dynamic*, while in the latter the filters are *static*.

Page 1: Filter 1

Type	Filter type. (S. information on the types of filters in "Notes and suggestions" at the end of the chapter). "Off" means that the filter is not active. Value range: Off, Low Pass, High Pass, Band Pass, Parametric Boost, Parametric Cut.
Cutoff Frequency	Filter cutoff frequency, or frequency at which the filter intervenes. The Cutoff Frequency is the same for all the notes of a Sound, unless you programme Filter Tracking (s.). The Cutoff Frequency can be modified by the Filter Envelope, the Key On Velocity, the Aftertouch, the Lfo and by the Midi Controllers 14, 15, 20. Default: 0. Value range: 0 ... 191.
Resonance	Resonance creates a peak of emphasis at the Cutoff frequency. Resonance with a high value can place the filter on "auto-oscillation", producing a whistling sound rich in harmonics. To avoid distortion, assign a negative value to the "Out gain" parameter. Resonance can be modified by Key On Velocity. Value range: 0 ... 127.
Cutoff dynamic sensitivity	Links the Cutoff Frequency to Key On Velocity. Positive values increase the Cutoff Frequency by playing harder (the filter opens allowing more partials to pass and the sound becomes brighter), negative values produce the inverse effect (the filter is closed and the sound becomes "dull"). The value 0 does not affect the Cutoff Frequency. Value range: -7 ... +7.
Resonance dynam. sens.	Links Resonance to Key On Velocity. Positive values enhance the Resonance with increased dynamic force while negative values give the inverse effect. The value 0 does not affect the Resonance. Value range: -7 ... +7.
Cutoff touch sensitivity	Links the Cutoff Frequency to Aftertouch. Positive values increasingly open the filters with increased Aftertouch pressure, negative values have the inverse effect. The value 0 does not affect the cutoff frequency. Value range: -7 ... +7.
Out gain	Increases or attenuates the output level of the signal. This parameter has two applications: (1) attenuation of the output level when the Resonance or a Parametric Boost produces a signal distortion, (2) intensification of the signal when a Parametric Cut attenuates the signal, or when you want to create a distorted signal. Value range: -2 ... +2.

Important. The "Out Gain" parameter may produce signal peaks that can distort the signal or even damage the audio system. Use this parameter with caution.

Page 2: Filter 2

The parameters are identical to those described above, but applied to Filter 2.

Suggestion: To copy the parameters of Filter 1 page to the Filter 2 page and obtain a single 4-pole filter, use the Clipboard in the following manner:

1. Set the display to the "Filter 1" page.

2. Press the CLIPBOARD button to open the Clipboard:



3. Select one of the six Clipboard locations and copy the “Filter 1” page by selecting the “Save” command. The “Filter 1” page is copied as a “clip” in the Clipboard:



4. Return to the edit by pressing EXIT or the SOUND button in the Edit section and pass on to the “Filter 2” page.

5. Press CLIPBOARD to open the Clipboard, select the clip you have just saved and select the “Move” command.

6. The “Filter 1” page is copied into the “Filter 2” page and the clip is removed from the Clipboard.

Additional information on use of the Clipboard are given in the chapter on Clipboard.

Page 3 Filter 1 Tracking

Options

These three options permit you to divide the Tracking “curve” into different segments; in order to permit a more or less refined programming of the Tracking across the keyboard.



1 segm 1 segment. The Tracking is essential and provides a constant variation of the Cutoff frequency across the keyboard. The “Key” parameter cannot be modified.



3 segm 3 segments. The Tracking consists of 3 segments which create a curve with different variations across the keyboard.

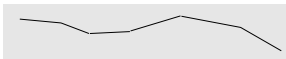

6 segm 6 segments. The Tracking curve is greatly divided, allowing a complex programming of the Cutoff Frequency across the keyboard.

Parameters

The three parameters displayed across the bottom part of the Tracking curve can be accessed by tapping repeatedly on ENTER. The selected parameter can be modified with the DIAL (the “Key” and “Level” parameters also with the NUMERIC KEYPAD).

point One of the extreme ends of a segment. Rotation of the DIAL selects one of the points of the Tracking curve (1, 2, or 1, 2, 3, 4, or 1, 2, 3, 4, 5, 6, 7).

key Determines the keyboard position for the point in edit. The extreme points (A#0, C8) cannot be modified.

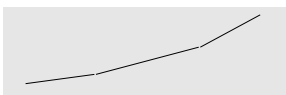

level The Cutoff Frequency offset with respect to the value programmed on the first page. Normal use of this parameter requires that the Tracking curve be an ascending whole or broken line. Value range: -63 ... 0...+63.

Detailed procedure Follow the steps set out below to access and edit the Tracking parameters:

1. Tap ENTER to select one of the parameters “Point”, “Key” (if possible), or “Level”.
2. Rotate the DIAL to select a POINT, to change the KEY note or modify the LEVEL.
3. Press ENTER to pass on to the next parameter. After “Level” you will return to “Point”.

Page 4: Filter 2 Tracking

Identical to the Tracking described above, but applied to Filter 2. Use the Clipboard if you want to copy the “Filter 1 Tracking” page to the “Filter 2 Tracking” page to obtain a 4-pole filter.

Filter Envelope (DC and DO sounds)

4-pole Filter:
 Programme identical parameter values for the "Filter 1" and "Filter 2" pages in the previous editor; the "Filter 1 Tracking" and "Filter 2 Tracking" pages in this editor; the Envelope Amount F1 and F2 parameters in the "Filter Envelope Control" page of this editor (only DC and DO Sounds).

DC and DO Sounds have dynamic filters which modify the harmonic content of the sound with respect to time. SO Sounds have static filters and consequently do not have the Filter Envelope editor in the main edit sound menu.

One envelope curve is common to both filters, even if the modulation depth can be programmed independently in the two filters. The envelope consists of two parts accessed in pages 2 and 3: "Filter Key On Envelope", which controls the filter variations while pressure is applied to the note, and "Filter Key Off Envelope", which controls filter variations after releasing the notes (Release phase).

The filter envelope can have different velocities across the keyboard extension thanks to the "Filter Envelope Tracking" programmed in page four.

Page 1: Filter Envelope Control

Envelope amount F1	Activates the envelope for Filter 1 and regulates its modulation depth on the Cutoff Frequency. Negative values invert the Filter Envelope. Value range: -10 ... +10.
Envelope amount F2	This operates in the same way as Envelope amount F1, but refers to Filter 2. <i>Note:</i> In order to produce a 4 pole filter, assign the same "Envelope amount" value to Filters 1 and 2.

Page 2: Filter Key On Envelope

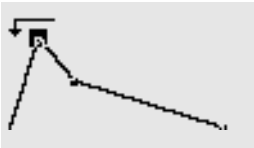
Commands	The option/command column shows specific options for this page.
	<p>set loop Activates the loop (envelope repetition). Determines the starting point of the envelope repetition. When the Filter Key On envelope reaches its terminal point, it loops back to the beginning. The cycle repeats continuously until you release the keys. The loop is represented by an arrow which indicates the initial loop point.</p> <p>To eliminate the loop, select its first segment again and then select "Set Loop".</p> <p>A loop on the Filter Envelope causes a cycle of opening/closing of the Sound.</p> <p><i>Note:</i> Remember that the Filter Envelope is effective only if the Envelope Amount parameters have a non-zero value, and if Filters 1/2 have been used.</p>
	add segm Adds a segment. Inserts a new segment in the envelope curve immediately after the currently selected segment. <i>N.B.:</i> a maximum of up to 10 segments is permitted.
	del segm Cancels the segment selected.
	zoom in Enlarges the field of vision of the envelope up to 4 times.
	zoom out Reduces the field of vision of the envelope; it also cancels a <i>zoom in</i> . Reduces the envelope up to three times its standard size.

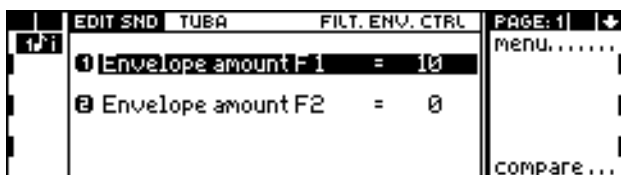

Page 1: Filter Envelope Control

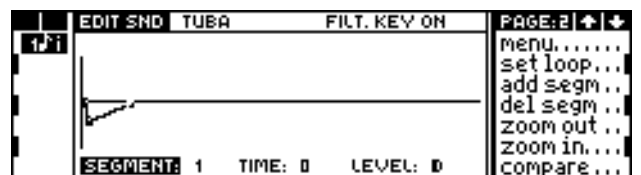

Page 2: Filter Key On Envelope

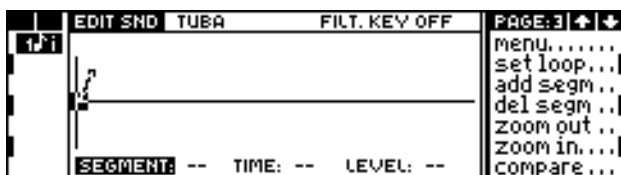

Page 3: Filter Key Off Envelope

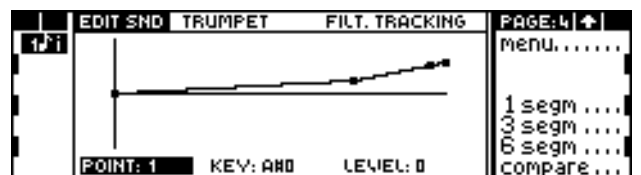

Page 4: Filter Envelope Tracking

Parameters

Tap **ENTER** to access the three parameters displayed under the Filter Key On Envelope curve. Edit the selected parameter with the **DIAL** ("Time" and "Level" also with the **NUMERIC KEYPAD**).

segment One of the envelope segments (1 - 10), whose end point is selected.

time Duration of the Segment. The maximum segment time is approximately 21 seconds. Value range: 0 ... 127.

level The Cutoff Frequency variation which the end point of the selected segment must reach. 0 corresponds to the Cutoff Frequency programmed, including the Filter Tracking programming (see page four of Filter 1/2). Value range: -63 ... +63.

Detailed procedure Follow these steps to access and modify the parameters:

1. Tap **ENTER** to select one of the parameters "Segment", "Time", "Level".
2. Rotate the **DIAL** to select a segment or to modify its duration or level. You can enter a "Time" and "Level" value on the **NUMERIC KEYPAD**.
3. Press **ENTER** to select the next parameter. After "Level" you will return to "Segment".
4. Select "Add segm." to add a new segment after the selected segment. Select "Del. segm." to cancel the selected segment.

Page 3: Filter Key Off Envelope

Commands

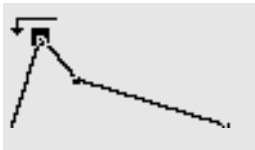

The option/command column shows specific options for this page.

set loop Activates the loop (envelope repetition). Determines the starting point of the envelope repetition. When the Filter Key Off envelope reaches its terminal point, it loops back to the beginning. The cycle repeats continuously until you release the keys. The loop is represented by an arrow which indicates the initial loop point.

To eliminate the loop, select its first segment again and then select "Set Loop".

A loop on the Filter Envelope causes a cycle of opening/closing of the Sound.

add segm Adds a segment. Inserts a new segment in the envelope curve immediately after the currently selected segment. *N.B.*: a maximum of up to 10 segments is permitted.

del segm Cancels the segment selected.

zoom in Enlarges the field of vision of the envelope up to 4 times.

zoom out Reduces the field of vision of the envelope; it also cancels a *zoom in*. Reduces the envelope up to three times its standard size.

Parameters

Tap **ENTER** to access the three parameters displayed under the Filter Key Off Envelope curve. Edit the selected parameter with the **DIAL** ("Time" and "Level" also with the **NUMERIC KEYPAD**).

segment One of the envelope segments (1 - 10), whose end point is selected.

time Duration of the Segment. The maximum segment time is approximately 21 seconds. Value range: 0 ... 127.

level The Cutoff Frequency variation which the end point of the selected segment must reach. 0 corresponds to the Cutoff Frequency programmed, including the Filter Tracking programming (s. page four of Filter 1/2). The Filter Key Off Envelope can terminate with non-zero values.

Value range: -50 ... +50.

Detailed procedure... Follow these steps to access and modify the parameters:

1. Tap **ENTER** to select one of the parameters “Segment”, “Time”, “Level”.
2. Rotate the **DIAL** to select a segment or to modify its duration or level. You can enter a “Time” and “Level” value on the **NUMERIC KEYPAD**.
3. Press **ENTER** to select the next parameter. After “Level” you will return to “Segment”.
4. Select “Add segm.” to add a new segment after the selected segment. Select “Del. segm.” to cancel the selected segment.

Page 4: Filter Envelope Tracking

Options

These three options permit you to divide the Tracking “curve” into different segments, in order to permit a more or less refined programming of the Tracking across the keyboard.



1 segm 1 segment. The Tracking is essential and provides a constant variation of the envelope completion velocity across the keyboard. The “Key” parameter cannot be modified.



3 segm 3 segments. The Tracking consists of 3 segments which create a curve with different variations across the keyboard.

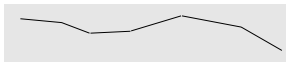

6 segm 6 segments. The Tracking curve is greatly divided, allowing a complex programming of the Cutoff Frequency across the keyboard.

Parameters

The three parameters displayed across the bottom part of the Tracking curve can be accessed by tapping repeatedly on **ENTER**. The selected parameter can be modified with the **DIAL** (the “Key” and “Level” parameters also with the **NUMERIC KEYPAD**).

point One of the extreme ends of a segment. Rotation of the **DIAL** selects one of the points of the Tracking curve (1, 2, or 1, 2, 3, 4, or 1, 2, 3, 4, 5, 6, 7).

key Determines the keyboard position for the point in edit. The extreme points (A#0, C8) cannot be modified.

level The Filter Envelope completion velocity offset (Key On and Key Off). Positive values increase the completion velocity, negative values slow it down. 0 corresponds to the “standard” duration of the segments programmed in the previous pages.

Value range: -63 ... 0...+63.

Detailed procedure Follow the steps set out below to access and edit the Tracking parameters:

1. Tap **ENTER** to select one of the parameters “Point”, “Key” (if possible), or “Level”.
2. Rotate the **DIAL** to select a **POINT**, to change the **KEY** note or modify the **LEVEL**.
3. Press **ENTER** to pass on to the next parameter. After “Level” you will return to “Point”.

Pitch Envelope

The tuning (pitch) of the Oscillators can vary over time, thanks to Pitch Envelope which is divided into two parts: the “Pitch Key On Envelope”, that regulates pitch variations while the note is pressed and the “Pitch Key Off Envelope”, that regulates pitch variations when the note is released (Release phase).

The Pitch Envelope can have different completion velocities across the keyboard extension, thanks to the “Pitch Envelope Tracking” programmed on page four.

The Pitch Envelope graphic representation is common to both oscillators, but you can programme the modulation depth and the positive/negative pitch values separately for each of the two oscillators.

In SO Sounds, the Pitch Envelope for Oscillator 2 (CH2) has no effect, but you can programme it in the eventaul case that the Sound is converted to a DC or DO Sound.

To render the Pitch Envelope independent from the two oscillators, assign a non-zero value to the “Detune” parameter in the WAVESET editor. The Sounds based on the Waveforms listed in the end of this chapter can have “Detune = 0”.

Page 1 Pitch Envelope Control

Pitch depth Ch1	Determines the depth of the action of the Pitch Envelope on the Sound-Channel (Oscillator) 1. Negative values invert the Pitch Envelope Shape and 0 excludes the action. Value range: -7 ... +7.
Pitch depth Ch2	As above, but for the Sound-Channel (Oscillator) 2.
Dynamic rate	Sensitivity of the Envelope to dynamic variations. With positive values, increasing the dynamics (playing harder) speeds up the Envelope development (the completion velocity). Negative values act inversely with increased dynamics. Value range: -7 ... +7.

Page 2 Pitch Key On Envelope

Commands The command/option column shows specific options for this page.

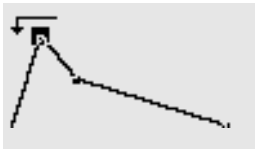

set loop Activates the loop (envelope repetition). Determines the starting point of the envelope repetition. When the Pitch Key On envelope reaches its terminal point, it loops back to the beginning. The cycle repeats continuously until you release the keys. The loop is represented by an arrow which indicates the initial loop point.

To eliminate the loop, select its first segment again and then select “Set Loop”.

add segm Adds a segment. Inserts a new segment in the envelope curve immediately after the currently selected segment. *N.B.:* a maximum of up to 10 segments is permitted.

del segm Cancels the segment selected.

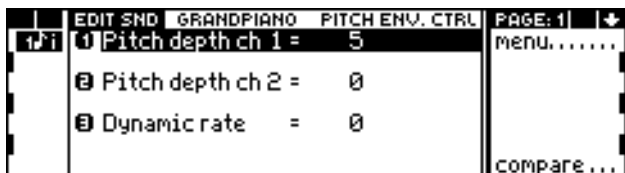

Page 1: Pitch Envelope Control

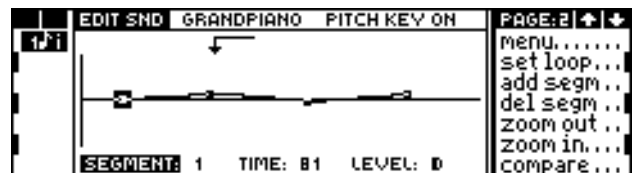

Page 2: Pitch Key On Envelope

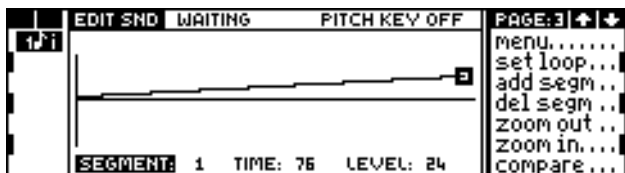

Page 3: Pitch Key Off Envelope

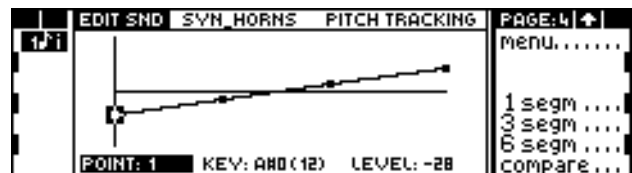

Page 4: Pitch Envelope Tracking

zoom in Enlarges the field of vision of the envelope up to 4 times.

zoom out Reduces the field of vision of the envelope; it also cancels a *zoom in*. Reduces the envelope up to three times its standard size.

Parameters

Tap **ENTER** to access the three parameters under the Pitch Key On Envelope symbol. Edit the selected parameter with the **DIAL** ("Time" and "Level" also with the **NUMERIC KEYPAD**).

segment One of the envelope segments (1 - 10), whose end point is selected.

time Duration of the Segment. The maximum segment time is approximately 21 seconds. Value range: 0 ... 127.

level Determines the value of the Pitch offset (the difference with respect to the standard value) at a given point. 0 represents the standard pitch. Value range: -63 ... +63.

Detailed procedure Follow these steps to access and modify the parameters:

1. Tap **ENTER** to select one of the parameters "Segment", "Time", "Level".
2. Rotate the **DIAL** to select a segment or to modify its duration or level. You can enter a "Time" and "Level" value on the **NUMERIC KEYPAD**.
3. Press **ENTER** to select the next parameter. After "Level" you will return to "Segment".
4. Select "Add segm." to add a new segment after the selected segment. Select "Del. segm." to cancel the selected segment.

Page 3: Pitch Key Off Envelope

Commands

The command/option column shows specific options for this page.

set loop Activates the loop (envelope repetition). Determines the starting point of the envelope repetition. When the Pitch Key Off Envelope reaches its terminal point, it loops back to the beginning. The cycle repeats continuously until you release the keys. The loop is represented by an arrow which indicates the initial loop point. To eliminate the loop, select its first segment again and then select "Set Loop".

add segm Adds a segment. Inserts a new segment in the envelope curve immediately after the currently selected segment. *N.B.:* a maximum of up to 10 segments is permitted.

del segm Cancels the segment selected.

zoom in Enlarges the field of vision of the envelope up to 4 times.

zoom out Reduces the field of vision of the envelope; it also cancels a *zoom in*. Reduces the envelope up to three times its standard size.

Parameters

Tap **ENTER** to access the three parameters under the Pitch Key Off Envelope symbol. Edit the selected parameter with the **DIAL** ("Time" and "Level" also with the **NUMERIC KEYPAD**).

segment..One of the envelope segments (1 - 10), whose end point is selected.

time Duration of the Segment. The maximum segment time is approximately 21 seconds. Value range: 0 ... 127.

level Determines the value of the Pitch offset (the difference with respect to the standard value) at a given point. 0 represents the standard pitch. Value range: -63 ... +63.

Detailed procedure Follow these steps to access and modify the parameters:

1. Tap **ENTER** to select one of the parameters “Segment”, “Time”, “Level”.
2. Rotate the **DIAL** to select a segment or to modify its duration or level. You can enter a “Time” and “Level” value on the **NUMERIC KEYPAD**.
3. Press **ENTER** to select the next parameter. After “Level” you will return to “Segment”.
4. Select “Add segm.” to add a new segment after the selected segment. Select “Del. segm.” to cancel the selected segment.

Page 4: Filter Envelope Tracking

Options

These three options permit you to divide the Tracking “curve” into different segments, in order to permit a more or less refined programming of the Tracking across the keyboard.



1 segm 1 segment. The Tracking is essential and provides a constant variation of the envelope completion velocity across the keyboard. The “Key” parameter cannot be modified.



3 segm 3 segments. The Tracking consists of 3 segments which create a curve with different variations across the keyboard.



6 segm 6 segments. The Tracking curve is greatly divided, allowing a complex programming of the completion velocity variation across the keyboard.

Parameters

The three parameters displayed across the bottom part of the Tracking curve can be accessed by tapping repeatedly on **ENTER**. The selected parameter can be modified with the **DIAL** (the “Key” and “Level” parameters also with the **NUMERIC KEYPAD**).

point One of the extreme ends of a segment. Rotation of the **DIAL** selects one of the points of the Tracking curve (1, 2, or 1, 2, 3, 4, or 1, 2, 3, 4, 5, 6, 7).

key Determines the keyboard position for the point in edit. The extreme points (A#0, C8) cannot be modified.

level The Pitch Envelope completion velocity offset (Key On and Key Off). Positive values increase the completion velocity, negative values slow it down. 0 corresponds to the “standard” duration of the segments programmed in the previous pages.

Value range: -63 ... 0...+63.

Detailed procedure Follow the steps set out below to access and edit the Tracking parameters:

1. Tap **ENTER** to select one of the parameters “Point”, “Key” (if possible), or “Level”.
2. Rotate the **DIAL** to select a **POINT**, to change the **KEY** note or modify the **LEVEL**.
3. Press **ENTER** to pass on to the next parameter. After “Level” you will return to “Point”.

Pan

In DC and DO sounds, the position of the sound in the “stereo panorama” (Pan) can be controlled *dynamically* by means of an envelope divided in two parts: the “Pan Key On Envelope”, that regulates the pan during the period that the key is pressed, and the “Pan Key Off Envelope”, that regulates the pan after releasing the keys (Release phase).

The “Pan Tracking” programmed in page four modifies the “relative” position of the sound across the keyboard extension. E.g. the sound in the bass section may be further to the left while in the treble section it may be further to the right.

In SO sounds the Pan is *static*; therefore there is no Pan envelope. In the only editing page available, you can link Pan to dynamics and Aftertouch.

Page 1: Pan Envelope Control (DC and DO Sounds)

Pan Envelope	Activates/deactivates the Pan Envelope. Status assignable: On/Off (---).
Pan dynamic sensitivity	Sensitivity of the Pan to dynamic variations. Positive values move the sound further right by increasing the dynamic force while negative values act inversely with increased dynamics. Value range: -7 ... +7.
Pan touch sensitivity	Sensitivity of the Pan to Aftertouch variations. Positive values move the sound further right by increasing the Aftertouch pressure, while negative values act inversely with increased Aftertouch. Value range: -7 ... +7.

Page 2: Pan Key On Envelope (DC and DO Sounds)

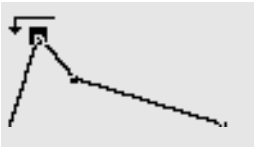
Commands	The command/option column shows specific options for this page.
	<p>set loop Activates the loop (envelope repetition). Determines the starting point of the envelope repetition. When the Pan Key On Envelope reaches its terminal point, it loops back to the beginning. The cycle repeats continuously until you release the keys. The loop is represented by an arrow which indicates the initial loop point.</p> <p>To eliminate the loop, select its first segment again and then select “Set Loop”.</p>
	<p>add segm Adds a segment. Inserts a new segment in the envelope curve immediately after the currently selected segment. <i>N.B.</i>: a maximum of up to 10 segments is permitted.</p>
	<p>del segm Cancels the segment selected.</p>
	<p>zoom in Enlarges the field of vision of the envelope up to 4 times.</p>
	<p>zoom out Reduces the field of vision of the envelope; it also cancels a <i>zoom in</i>. Reduces the envelope up to three times its standard size.</p>

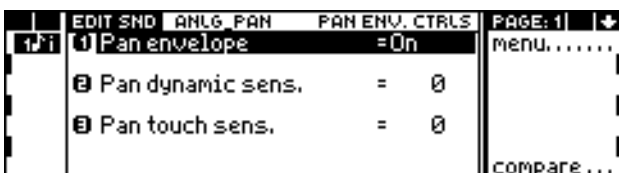

Page 1: Pan Envelope Control (DC and DO Sounds)

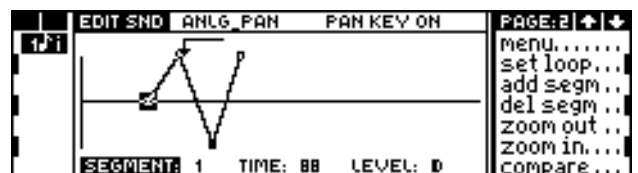

Page 2: Pan Key On Envelope (DC and DO Sounds)

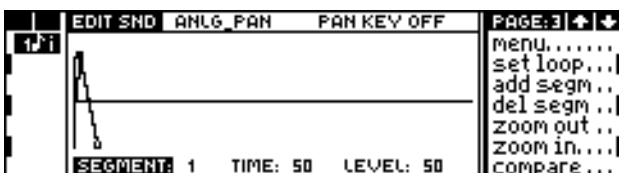

Page 3: Pan Key Off Envelope (DC and DO Sounds)

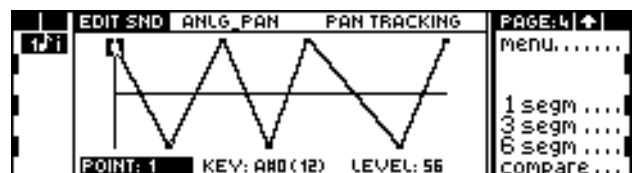

Page 4: Pan Tracking (DC and DO Sounds)

Parameters	<p>Tap ENTER to enter the three parameters under the Pan Key On Envelope symbol. Edit the selected parameter with the DIAL ("Time" and "Level" also with the NUMERIC KEYPAD).</p> <hr/> <p>segment One of the envelope segments (1 - 10), whose end point is selected.</p> <hr/> <p>time Duration of the Segment. The maximum segment time is approximately 21 seconds. Value range: 0 ... 127.</p> <hr/> <p>level Determines the value of the Pan offset (the difference with respect to the standard value) at a given point. 0 represents the centre of the Stereo Panorama. Value range: -63 ... +63.</p>
------------	---

Detailed procedure Follow these steps to access and modify the parameters:

1. Tap **ENTER** to select one of the parameters "Segment", "Time", "Level".
2. Rotate the **DIAL** to select a segment or to modify its duration or level. You can enter a "Time" and "Level" value on the **NUMERIC KEYPAD**.
3. Press **ENTER** to select the next parameter. After "Level" you will return to "Segment".
4. Select "Add segm." to add a new segment after the selected segment. Select "Del. segm." to cancel the selected segment.

Page 3: Pan Key Off Envelope (Sound DC and DO)

Commands	<p>The command/option column shows specific options for this page.</p> <hr/> <p>set loop Activates the loop (envelope repetition). Determines the starting point of the envelope repetition. When the Pan Key Off Envelope reaches its terminal point, it loops back to the beginning. The cycle repeats continuously until you release the keys. The loop is represented by an arrow which indicates the initial loop point. To eliminate the loop, select its first segment again and then select "Set Loop".</p> <hr/> <p>add segm Adds a segment. Inserts a new segment in the envelope curve immediately after the currently selected segment. <i>N.B.:</i> a maximum of up to 10 segments is permitted.</p> <hr/> <p>del segm Cancels the segment selected.</p> <hr/> <p>zoom in Enlarges the field of vision of the envelope up to 4 times.</p> <hr/> <p>zoom out Reduces the field of vision of the envelope; it also cancels a <i>zoom in</i>. Reduces the envelope up to three times its standard size.</p>
Parameters	<p>Tap ENTER to access the three parameters under the Pan Key Off Envelope symbol. Edit the selected parameter with the DIAL ("Time" and "Level" also with the NUMERIC KEYPAD).</p> <hr/> <p>segment One of the envelope segments (1 - 10), whose end point is selected.</p> <hr/> <p>time Duration of the Segment. The maximum segment time is approximately 21 seconds. Value range: 0 ... 127.</p> <hr/> <p>level Determines the value of the Pan offset (the difference with respect to the standard value) at a given point. 0 represents the centre of the Stereo Panorama. Value range: -63 ... +63.</p>

Detailed procedure Follow these steps to access and modify the parameters:

1. Tap **ENTER** to select one of the parameters “Segment”, “Time”, “Level”.
2. Rotate the **DIAL** to select a segment or to modify its duration or level. You can enter a “Time” and “Level” value on the **NUMERIC KEYPAD**.
3. Press **ENTER** to select the next parameter. After “Level” you will return to “Segment”.
4. Select “Add segm.” to add a new segment after the selected segment. Select “Del. segm.” to cancel the selected segment.

Page 4: Pan Tracking (DC and DO Sounds)

Options	<p>These three options permit you to divide the Tracking “curve” into different segments, in order to permit a more or less refined programming of the Tracking across the keyboard.</p> <hr/> <p>1 segm 1 segment. The Tracking is essential and provides a constant variation of the Pan across the keyboard. The “Key” parameter cannot be modified.</p> <hr/> <p>3 segm 3 segments. The Tracking consists of 3 segments which create a curve with different variations across the keyboard.</p> <hr/> <p>6 segm 6 segments. The Tracking curve is greatly divided, allowing a complex programming of the completion velocity variation across the keyboard.</p>
Parameters	<p>The three parameters displayed across the bottom part of the Tracking curve can be accessed by tapping repeatedly on ENTER. The selected parameter can be modified with the DIAL (the “Key” and “Level” parameters also with the NUMERIC KEYPAD).</p> <hr/> <p>point One of the extreme ends of a segment. Rotation of the DIAL selects one of the points of the Tracking curve (1, 2, or 1, 2, 3, 4, or 1, 2, 3, 4, 5, 6, 7).</p> <hr/> <p>key Determines the keyboard position for the point in edit. The extreme points (A#0, C8) cannot be modified.</p> <hr/> <p>level The Pan offset (the position with respect to the centre). This parameter determines the starting position of the Pan across the keyboard extension, and represents the actual value upon which the Pan Envelope acts. Value range: -50 ... 0... +50.</p>

Detailed procedure Follow the steps set out below to access and edit the Tracking parameters:

1. Tap **ENTER** to select one of the parameters “Point”, “Key” (if possible), or “Level”.
2. Rotate the **DIAL** to select a **POINT**, to change the **KEY** note or modify the **LEVEL**.
3. Press **ENTER** to pass on to the next parameter. After “Level” you will return to “Point”.

Pan Control (Sound SO)

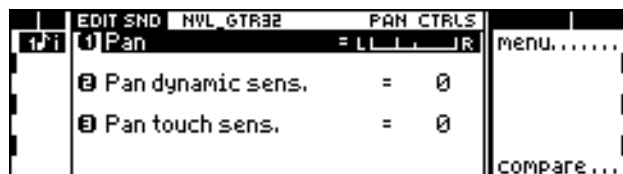

Pan Controls (SO Sounds)

Pan	<p>Position of the Pan. Use the DIAL or the NUMERIC KEYPAD to modify this graphic parameter. “0” corresponds to the central position. Value range: -31 (All Left) ... +31 (All Right).</p>
-----	--

Pan dynamic sensitivity	Sensitivity of the Pan to dynamics. Positive values move the sound further right by increasing the dynamic force while negative values act inversely.
-------------------------	---

Pan touch sensitivity	Sensitivity of the Pan to Aftertouch. Positive values move the sound further right by increasing the Aftertouch pressure, while negative values act inversely.
-----------------------	--

ROM-Waveforms with separate Pitch Envelopes for the two oscillators even when Detune=0

02 Honky Tonk	71 Muted_Trp2	112 Spatial	122 Atmosphere
18 Dulcimer	72 FrenchHorn	113 Fantasy_1	125 Syn_perc1
29 Syn_Organ	75 Brass-Trp	114 Fantasy_2	126 Syn_perc2
38 Accordion	77 Dual_Brass	115 Fantasy_3	127 Syn_perc3
39 Vocal_Gtr	83 Eng_Horn	116 Fantasy_4	128 Syn_perc4
41 12st_Gtr	87 Hardflute_1	117 Fantasy_5	129 Syn_perc5
60 Str_Glockn	88 Hardflute_2	118 VoiceBells	130 Syn_perc6
61 Orch_Str	89 Panflute	119 Vocal_Brth	131 Syn_perc7
62 Choir	109 SpectBells	120 Voice_Glk	132 Syn_perc8
66 Symph_Orch	110 Machinery	121 Angels	133 Syn_perc9

Notes and suggestions

Waveform Not all Waveforms cover the entire extension of the keyboard. This becomes particularly evident when you use an 88 note master keyboard on which you can reach the extremes of the extension.

The problem is due to a lack of samples at the extremes of the keyboard. During the creating phase of a Waveform, considerations are made for the quality of the sound and the amount of memory necessary to store all the samples which constitute the Waveform; if some high or low end samples are lacking in musical quality (e.g., the lower notes of a violin Waveform, or the higher notes of a doublebass Waveform), it is preferable to eliminate them to avoid using up precious memory.

Volume, Dynamic & Aftertouch The Volume of a Sound can be controlled in live situations by dynamics and aftertouch variations (*programming in the Volume editor*). If you set very sensitive values for both controls (e.g. +7 assigned to both dynamics and aftertouch) the Sound will be very difficult to control and easily susceptible to sudden volume variations.

Loop and Lfo By programming a loop on two segments of a Key On Envelope which create an ascending and descending ramp (\wedge) you can simulate a Tremolo effect, without using the Lfo editor.

A loop of this kind on a Key On Pitch Envelope will simulate a more realistic Vibrato effect than the effect obtained with the Lfo.

Key Off Envelope Thanks to the greatly articulated Key Off Envelope (Release envelope) of the S Series, you can create some very interesting effects. In practice, you can render a Sound "live" after releasing the keys.

For example, try programming a Key Off Envelope of the following kind with a Sound such as *I2_St_Gtr*:

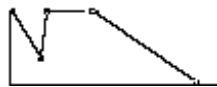

When you release the key the sound begins to fade and then reappears, it is held for an instant and then fades away gradually.

Lfo Lfo can be applied to several different sound parameters. The effect produced depends on the parameter affected:

<i>Amplitude</i>	->	<i>Vibrato</i>
<i>Pitch</i>	->	<i>Tremolo</i>
<i>Cutoff Freq.</i>	->	<i>Wha-wha</i>

Filters The action of the filters on the sound is represented by curves:

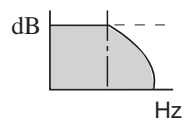

Low Pass (attenuates the high end frequencies)

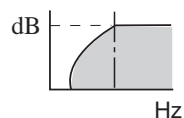

High Pass (attenuates the low end frequencies)

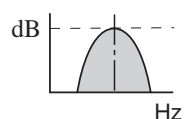

Band Pass (attenuates the frequencies above and below the C.F.)

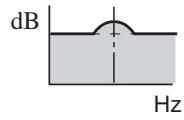

Parametric Boost (enhances the frequencies around the Cutoff

Frequency)

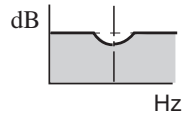

Parametric Cut (attenuates the frequencies around the Cutoff Frequency)

The slope of these curves is determined by the attraction capacity of the “poles”. The S Series can have two 2-pole filters or one 4-pole filter. The 4-pole filter creates a clearer slope and consequently a fuller and more aggressive sound.

Resonance enhances the frequencies in close proximity of the Cutoff Frequency, rendering the filter curves more complex:

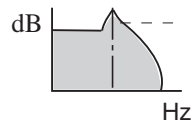

Resonance

Resonance was a very typical feature of classic analog synthesisers. As an example, listen to the Sound *Invasion 82-2*.

Some examples of filter curves:

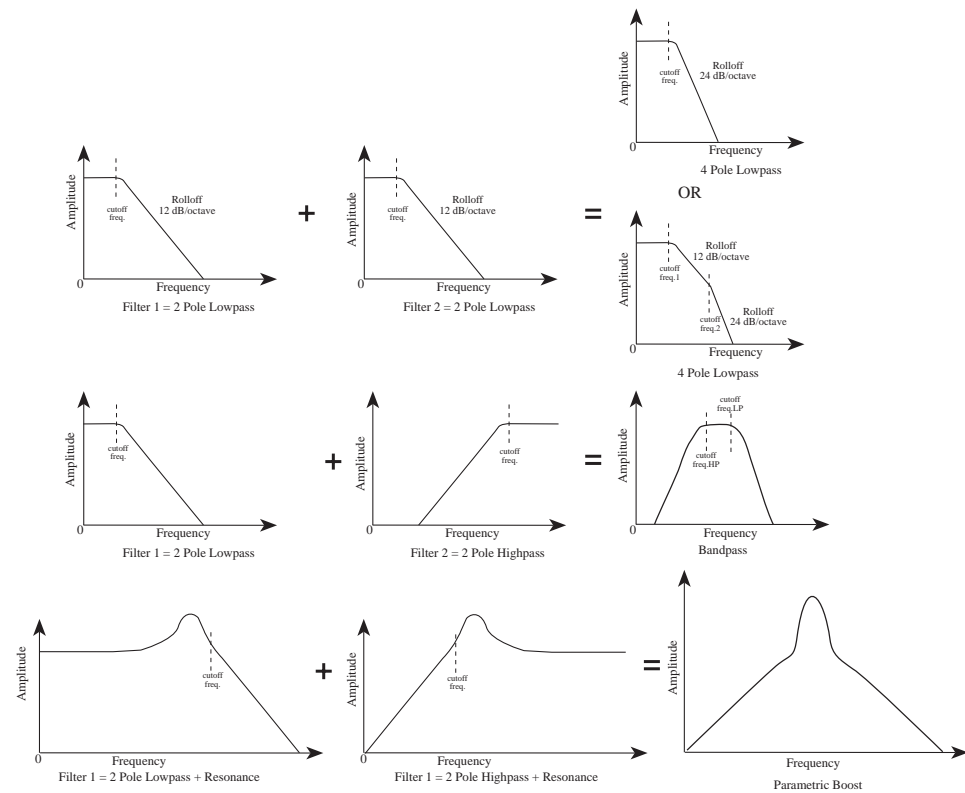

The two filters of the S Series can be also considered as two band equalizers and can be programmed accordingly.

6 SAMPLE TRANSLATOR

Sample Translator is a Waveform creator and editor incorporated in the S Series. Its principal functions are as follows::

- the reading of samples from Ms-Dos/Atari floppy disks, in Avalon, Sound Designer, Sample Vision and Wave formats;
- the reading of samples from Akai S1000 floppy disks;
- the reception and transmission of samples via MIDI;
- the modification of samples and the creation of a multi-sample (the multi-sample becomes a standard Waveform of the S Series);
- the modification of the waveform of the RAM-Sounds that contain an imported sample (Sounds with the  symbol).

Accessing Sample Translator

Note: Sample Translator ignores all editing tasks carried out on a Sound after accessing edit sound, and places in edit the original Waveform of the Sound with which you entered the edit environment.

1. Enter EDIT SOUND with any type of Sound. The “Sample Translator” command appears in the main menu:

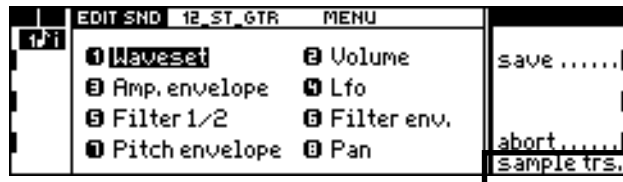

2. Select the “Sample Translator” command from the main menu of EDIT SOUND. Any modifications being made to the Sound currently in edit will be cancelled:

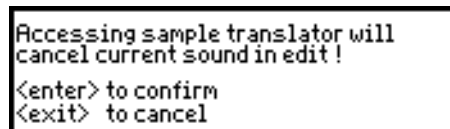

Once you have entered the Sample Translator mode, one of the following situations may be shown:

- Access from a Sound that does not contain imported samples (e.g. from a Rom-Sound).

- Sample Translator enters edit without samples:

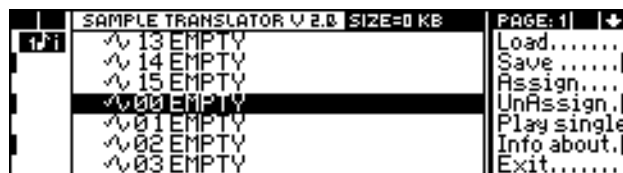

Waveform, page 1. (No sample is loaded).

- Access from a Ram-Sound containing imported samples (Sound showing the  symbol) not created with Sample Translator;

- Sample Translator enters edit without samples.

- Access from a Ram-Sound containing imported samples (Sounds showing the  symbol), created with Sample Translator;

- Sample Translator enters edit with the sample of the initial Sound (or the samples, if the Waveform is made up of a multi-sample). If the Sound is a DO

type, the Waveform will enter edit only if it is the Waveform of the first oscillator.

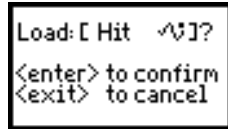

"Load the Waveform 'Hit'?"



Waveform, page 1. (A sample loaded to slot 00).

The instrument status during the Sample Translator tasks

The "Solo" mode is activated automatically when you enter EDIT SOUND. However, in EDIT SOUND you can exclude the "solo" function, while you cannot in Sample Translator.

Controlling the S2R

The S2R must operate in Midi-Common mode, or track 1 must be selected. If Midi 1 channel is not assigned to track 1, remember to select track 1 before you enter Sample Translator.

Temporary escape from Sample Translator

Thanks to multitasking it is possible to temporarily escape from Sample Translator to access other operating environments, without losing work in progress in Sample Translator. The SOUND button in the Edit section continues to flash to remind you that a Sound is currently in edit. To return to Sample Translator simply press the SOUND button of the Edit section.

A closer look at Sample Translator

The operating environment of the Sample Translator consists of a main display (spread over two pages), called WAVEFORM, from which you can access secondary displays by means of the commands which appear on the right.

The list of samples making up the Waveform are displayed at the centre of the WAVEFORM display (from 1 to 16). The sixteen locations are selected with the DIAL. The commands and options are in the two Waveform pages.



Waveform, page 1



Waveform, page 2

The Waveform display

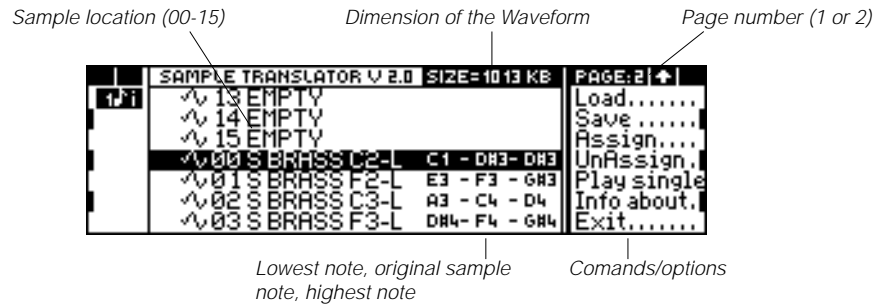

Load

Loads a sample from Akai S1000 or Atari/Ms-Dos floppy disks, or sets the instrument to receive samples in MMA/sds format via Midi. The sample received is loaded to the currently selected location, replacing the existing sample, if present.

1. Select the command. The selection window appears which permits you to choose between the source "disk" and an "MMA/sds" file received via Midi:



Select with the DIAL and press ENTER.

2. A different window will appear according to your choice:



"disk" choice



"MMA/sds" choice

Disk

Select one of the two options with the DIAL and press ENTER.

dos/atari Floppy disk in Ms-Dos (DD or HD) format or Atari (only DD) format. It can contain samples in Sound Designer (.SD), Sample Vision (.SMP), Avalon (.SMP) or Wave (.WAV) formats.

akai Floppy disks in Akai S1000 (type HD) format. It can contain Samples (.S) or Programs (.P).

MMA/sds

Enter the number of the sample to be received via Midi from the external device (sampler or computer). Specify the number (0 ... 255) and press ENTER to receive the sample in the currently selected location.

Note: The MIDI channel on which the sample must be received is the MIDI-COMMON, or Channel 1 if MIDI-COMMON is deactivated.

Possible error messages during reception:



The transmission channel of the external device probably does not correspond to the MIDI-COMMON or to channel 1. Alternatively, the external device is not able to receive the transmission request; in this case you must start transmission from the control panel of the external device.

Set the appropriate MIDI channels or return to the Waveform display and start the transmission from the control panel of the external device.

Save

Saves the Waveform created in a new Sound. Only samples which have been assigned an extension limit with the "Assign" command are saved in the Waveform.

The new Waveform is added at the end of the list of Waveforms (accessed in EDIT SOUND from the WAVESET editor) and may be used to create other new Sounds.

1. Select the command and enter the name of the Waveform:



2. Press ENTER to confirm and enter the name of the Sound:



3. Press ENTER to confirm and select a location in the Sound Library where the new Sound can be saved (form *Bank Select-Program Change, xxx-yyy*):



(Sample Translator displays only empty locations of the Sound Library).

Assign

Once loaded, a sample will play across its entire note range. This command assigns a note range to the selected sample, delimited by a low note and a high note.

The keyboard zones to which the samples are assigned cannot be superimposed.

Note: Only the assigned samples become part of the Waveform and are saved at the end of the edit operations in Sample Translator.

1. Select the command. The following selection window is displayed:

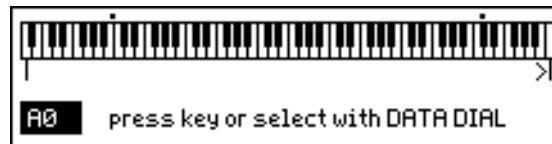

2. Play the lowest note (or rotate the DIAL) and press ENTER. Play the highest note (or rotate the DIAL) and press ENTER.

Once the assign procedure has been completed, the lowest note of the scale, the original sample pitch and the highest note of the scale are displayed next to the name of the sample.

UnAssign

Erases all the extension limits of the currently selected sample.

Play Single

Opens the Play Single display where you will find the graphical representation of the waveform relating to the sample selected in the Waveform display. In this page you can play back the sample on its own (even if has been "assigned"), modify its level and transmit it via Midi to an external device (sampler, computer).

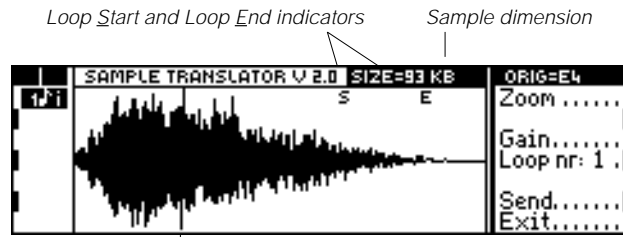

Graph of the waveform of the sample
(from Sample Start to Sample End)

Zoom	<p>Enlarges the sample.</p> <ol style="list-style-type: none"> 1. Select the command. A vertical line representing Zoom Start appears. 2. Move the line with the DIAL and press ENTER to confirm. 3. Another vertical line appears representing Zoom End. Move the line with the DIAL and press ENTER to confirm. <p>unzoom Removes the zoom. This command appears when the zoom is active.</p>
Gain	Regulates the volume of the sample with respect to other samples of the Waveform. The value is shown as a percentage.
Loop nr: (x)	<p>Selects the loops whose Loop Start and Loop End points are shown.</p> <p>Note: The S Series uses only the first loop of any sample.</p>
Send	<p>Sends the sample to an external device (sampler or computer) connected via MIDI.</p> <p>Note: The MIDI channel on which the sample is received from the external device must be the channel corresponding to the MIDI-COMMON, or, if this is not active, MIDI Channel 1.</p> <p>Possible transmission errors:</p>
	<div data-bbox="151 1272 440 1361" data-label="Image"> </div> <p>Very probably the Midi channel of the external device does not correspond to the Midi-Common of the Music Processor or to channel 1. Alternatively, the external device is not able to receive the transmission start message.</p> <p>Programme the Midi channels correctly, or return to the Waveform display and start the reception from the control panel of the external device.</p>
Exit	Returns to the Waveform display.

Info About

Opens the INFO ABOUT display which shows information on the dimensions of the Waveform and the selected sample, the sample pitch, the position of the Loop Start and Loop End points of the sample.

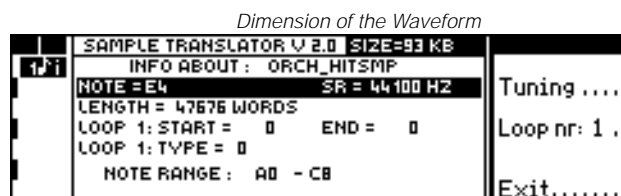

Information about the selected sample

Commands/options	<p>tuning Provides a reference for the sample pitch, producing the exact note played on the keyboard with a sinusoidal wave.</p> <hr/> <p>loop nr. (x) Permits the selection of one of the eight loops of the sample. Only the first loop is used by the S Series , but it is also possible to modify the other loops.</p> <hr/> <p>note link This option appears only when the "Note" parameter is in edit mode. It automatically varies the "SR" parameter when the "Note" parameter is modified.</p> <hr/> <p>exit Returns to the Waveform display.</p>
Info About (cannot be modified)	Name of the sample.
Note	<p>Original pitch of the sample.</p> <hr/> <p>note link See above</p>
SR	Sampling Rate. The frequency corresponding to the note shown by the "Note" parameter.
Length (can not be modified)	Length of the sample in <i>words</i> . A <i>word</i> is the unit of measure of the sample. Since the S Series uses a 16 bit sampling technique, 1 <i>word</i> = 2 bytes. (1 byte = 8 bit).
Loop Start	The starting point of the loop. It is possible to modify any one of the eight sample loops, but only the first loop is exploited by the Sounds created with Sample Translator. To select the loop that requires modifying, use the "Loop nr: (x)" command in the command/options column.
Loop End	<p>Ending point of the loop. See the previous parameter.</p> <hr/> <p>Possible error messages during the edit of the Loop Start and Loop End:</p> <hr/> <p>The Sounds based on this Waveform cannot be converted into Dual Oscillator or Single Oscillator Sounds.</p>
Loop type	<p>The possible loop types are as follows:</p> <hr/> <p><i>type 0</i> (loop deactivated)</p> <hr/> <p><i>type 1</i> (loop is read in forward direction only)</p> <div data-bbox="454 1220 965 1310" style="text-align: center;"> </div> <hr/> <p><i>type 2</i> (loop alternately read forwards and backwards; it is not exploited by the S Series but it can be transmitted to a sampler)</p> <div data-bbox="454 1433 965 1523" style="text-align: center;"> </div>
(cannot be modified)	The keyboard zone to which the sample has been assigned.. If the sample has not been assigned, the message "Unassigned" appears in place of the notes.



Exit

Escape command from the Sample Translator. If you have created a Waveform the instrument asks you if you wish to cancel your edit work

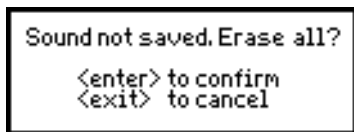

If you press **ENTER** the Waveform will be lost. If you press **EXIT**, you can save your Waveform with "Save" before escaping.

Cut End

An option which can be selected or de-selected. If selected, the section following the Loop End is "cut away" after loading the sample.

Delete

Erases the currently selected sample from memory.

Copy

Copies the currently selected sample to a "clipboard".

Paste

(This function appears after a Copy operation). Inserts the sample copied to the "clipboard" to the currently selected location. This operation saves memory because the sample is not copied "physically", but only read twice by Sample Translator. It is extremely useful for inserting the same sample in two sections of the keyboard which are not adjacent without having to load the sample twice.

7 Sound Patch and Drumkit

Two or more Sounds can be combined to form SOUND PATCHES or DRUMKITS with the advantage that you can obtain a variety of sounds which occupy only one location in the Sound Library. Sound Patches and Drumkits allow the use of only one Midi channel to control complex sounds which would otherwise require the use of several tracks.

In the SOUND LIBRARY the Sound Patches and Drumkits are identified by a symbol “|||” next to the name. The EDIT SOUND PATCH environment is different to EDIT SOUND.

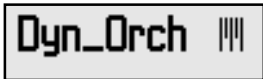

Sound Patches are combinations of different Sounds that play across the keyboard, separated by a dynamic threshold so that the higher level is triggered by playing harder (two different dynamic levels: layer 1 & 2). An example of a Sound Patch is shown below. The keyboard is divided into two sections, with a combination of Fretless and Slap Bass in the bass section (the first activated by a low dynamics value and the second by a high dynamics value) and Tenor Sax in the treble section.

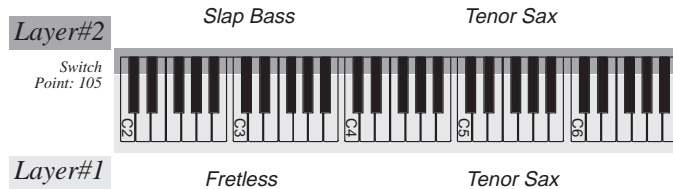

The Drumkits are Sound Patches consisting of percussion instruments, a different one assigned to each note of the keyboard. Drumkits allow you to use just one track for all the percussion instruments required for a musical composition.

To edit Sound Patch or a Drumkit, assign it to the selected track and press the SOUND button in the Edit section.

The SOUND PATCH edit environment

The edit environment is spread over two pages, each dedicated to one of the two dynamic levels of Sound Patch/Drumkit.

All the parameters which appear on a page refer to the currently selected note (“Key note”).

Commands/options

Expand Copies the parameter settings of the displayed note across a note range (saves repeating a series of identical parameter settings for a given number of notes).

1. Select the command. The image of a keyboard appears on the display:

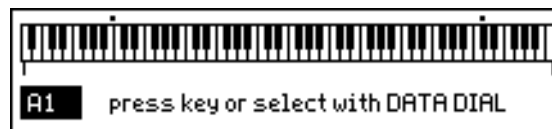

2. Play the lowest note required (or rotate the DIAL) then press ENTER.
Play the highest note required (or rotate the DIAL) and press ENTER.

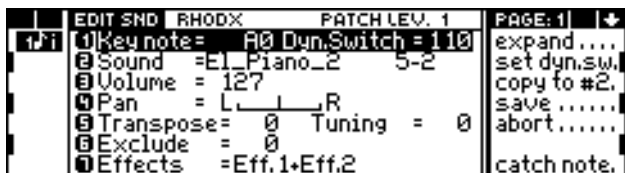

Edit SoundPatch/Drumkit, Patch Level 1

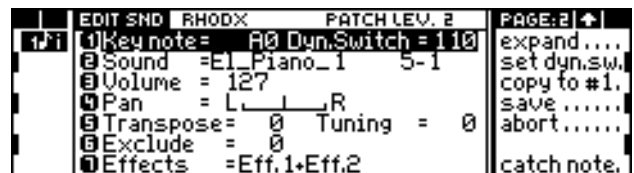

Edit SoundPatch/Drumkit, Patch Level 2

Set dynamic switch The dynamic threshold that divides the two levels. This sets the maximum dynamic level of the first level. 126 and 127 exclude the second level.
Value range: 0 ... 127.

Copy to level (x) Copies the entire programmed status of level 1 to level 2, or vice versa.

Suggestion: Use this command to differentiate just a few notes between the two levels; for example, only the roll of a Drumkit.

1. Programme level 1, note by note, with all the instruments of the drumkit. Insert the "Roll" in D2:

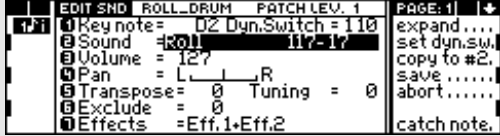

2. With the "Copy to #2" command, copy all the programming of level 1 to level 2.
3. Pass on to the second level, in the second page of the display, and access the edit of note D2:



4. Assign the Sound "Snare Drum 1" to note D2 of the second level:



Save Saves the Sound Patch/Drumkit.

1. Select the command. The Sound Library entry page is displayed:



2. Select an empty location.
3. If necessary, change the name of the Sound Patch using "Name".
If the original Sound Patch is a Rom-Sound, the Music Processor automatically attaches an asterisk (*) after the new name in order to avoid duplications of the name in the Sound Library.
4. PRESS ENTER to save the SoundPatch.

Abort Erases all the modifications made to the Sound Patch and escapes from edit mode.

Catch note Assigns the note played on the keyboard to the "Key Note" parameter. To be rendered operative, S2R must be controlled via MIDI-COMMON.

1. Select the command. The following message appears on the display:

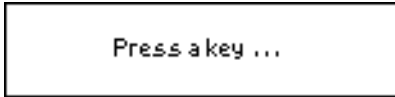

2. Play the note you wish to assign to the "Key Note" parameter.

Parameters

Key Note	Shows the note currently in edit in the active level. Use the DIAL or the command "Catch note" to select the note.
Sound	Determines the sound assigned to the note.
Volume	Determines the Volume of the edited note. Value range: 0 ... 127.

Pan	Position of edited note in the stereo panorama. Value range: -32 (All Left) ... +32 (All Right).
Transpose/Tuning	transpose Transposes the edited note by semitones. Value range: -88 ... +88.
	tuning Fine tunes the transposition in steps of 1/64th of a semitone. Value range: -64 ... +64.
Exclude	A linking number between notes which exclude each other. Notes that have been assigned the same "Exclude" number cannot play simultaneously. For example, if an Open Hi-Hat in a drumkit has the same Exclude number as a Closed Hi-Hat, when one of the two instruments plays, it excludes the other, interrupting it abruptly. This parameter allows you to simulate the abrupt sound change of an acoustic instrument when it is played in different ways. Other examples: Conga, Conga Slap, Conga Accented; Snare Drum and Roll; Ride and Ride Cup; Pick Bass and Slap Bass. Value range: 0, 1 ... 3.
Effects	Effects active for the edited note. Value range: Eff1+Eff2, Eff1, Eff2, --- (Off).

Notes and suggestions

Pan In a drumkit it is extremely important to programme the Pan very accurately in order to position the percussion instruments realistically in the stereophonic panorama. A very common "trick" is to stagger the Toms, so that the sound gives the impression of moving through the stereo channel during the rolls.

Examine the drumkits of the standard Sound Library to discover other programming tricks.

Effects Assigning a different effect to each instrument of the drumkit can create extremely suggestive effects. For example, you can assign reverb (Eff1) to the Bass Drum and both reverb and delay (Eff1+Eff2) to the Snare Drum.

Or you can assign Eff2 to Patch Level 1 (low dynamics) and both Eff1 and Eff2 to Patch Level 2 (higher dynamic level), so that the reverb effect appears only when the volume of the sound is higher.

8 SEQUENCER AND SONG

What is a Sequencer – The S Series Sequencer

The Sequencer (or MIDI recorder) is a recorder of MIDI events (notes, pitch bend, modulation...), capable of creating multi-timbral songs (tracks) and reproducing them using the internal sound generator of the instrument or the sound generator of other instruments connected to MIDI OUT.

The Sequencer of the S Series can record songs consisting of 16 tracks, modifying the events recorded with the general commands or single event-edit procedures.

In addition to the 16 tracks where notes can be recorded, a “ghost” track (the Master Track) is also recorded which contains all the data pertaining to the Performance and Effect changes, Tempo and main Volume variations.

In the S Series the Songs are associated to Banks of Performances, and these constitute the Banks/Songs.

Playback and Record

While a Song is in Record mode (RECORD BUTTON FLASHING) it is not possible to access certain functions, such as the “Save Performance” command:

STOP!
Sequencer in RECORD or BUSY
Operation not allowed!

A Song can be recorded (Record) or played back (Playback). Song playback and recording can be controlled in the Playback and Record displays (Figs. 1 and 2).

- Press RECORD to activate the Record display (and to access all the recording operations).

To enter Playback you must (a) enter EDIT SONG by pressing SONG in the Edit section, and, if necessary (b) select “Rec/play” in the Edit Song display.

The Playback display shows the Song parameters and allows you to modify the Tempo. You can edit the other parameters in EDIT SONG (s.).

The Song and the Performance Bank

During the recording you can record the Sound changes for each track as well as the Performance changes which change the general configuration of the instrument while the Song is playing. The Performance can be used to perform complex tasks, such as changing the track configurations and all the Sounds played, as well as simple variations, such as assigning Effects to the tracks.

A Song requires a Bank/Song with suitable Performances. If none of the ten standard Bank/Songs contain Performances which suit the Song, you must create a Bank/Song with different Performances.

A new Bank/Song must be created even when the instrument has only one Bank/Song (this can happen when you load the contents of a floppy disk or cancel a Bank/Song).

In some cases it may be necessary to cancel the Song that resides in the Bank/Song to record a new Song with the Bank/Song Performances (e.g. cancel the Demo Song of the Bank/Song 1 to record a new Song).

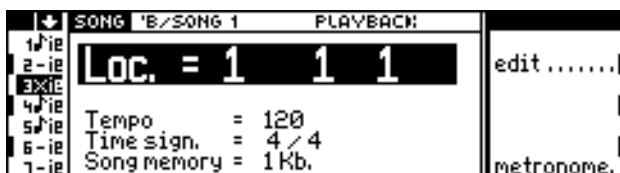

Figure 1: “Playback” display

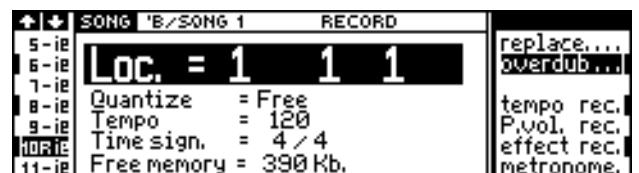

Figure 2: “Record” display

The sequencer controls

The buttons situated directly below the display control the recording or playback of a song:

record Places the Song selected in "record" mode.

play Starts the playback and the recording of the Song .

<< and >> Fast forward and rewind of the Song. Holding them down increase the velocity of the forward and rewinding action. These commands are not active during recording.

clock Displays the metronome Tempo (clock) and allows you to modify it in real time by means of the DIAL.

Creating a Song

Creating a Bank/Song

There are two ways to choose from: create a new Bank/Song or prepare a copy of an existing Bank/Song.

(A) *Creating a new Bank/Song:*

1. Select the "Save Performance" command from the main display.
2. Specify the new Bank/Song to create.
3. Confirm the save operation. As well as a new Performance, a new Bank/Song which houses the Performance is created.

Note: Ten Bank/Songs are already present by default. These can be cancelled with the "Delete Bank/Song" function of the UTILITY button.

(B) *Copying from another Bank/Song (both the Performance Bank and associated Song):*

1. Select the Bank/Song to copy.
2. Press the UTILITY button to gain access to the Utility display:

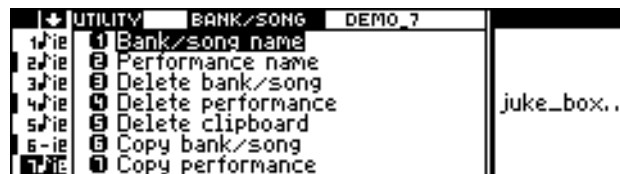

3. Select the <Copy "Bank/Song"> option. You are prompted to specify a destination for the copied Bank/Song:



4. Select the Bank/Song destination and confirm.

Creating a Performance with default values

You can reset all the tracks to default values:

1. Enter EDIT PERFORMANCE/PRACTICES by pressing the PERF. TRACKS button in the Edit section:

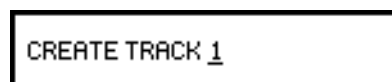

- Use the DIAL to select "All" and press ENTER twice to create 16 tracks with default values (Sound = GrandPiano, Volume = 127, Transpose = 0 ...)

Cancelling the Song

You can cancel a Song and maintain the Performance Bank intact in the following manner:

- Select the Bank/Song.
- Press the SONG button in the Edit section. If the Playback display appears, select the "Edit" option to recall the Edit Song display:

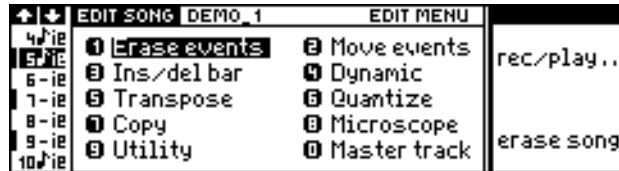

- Select the "Erase Song" command and confirm.

Recording a new Song

Select the Bank/Song in which you want to record the new Song.

- Press the RECORD to activate the Song "record" mode. The button starts to flash and the "Record" display is shown, partially covered by a dialogue window which prompts you to select the track or tracks to record:

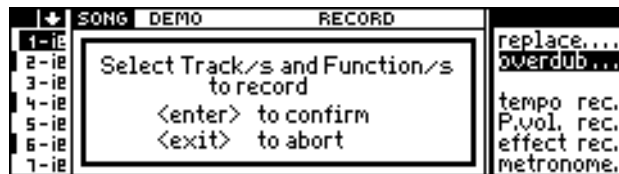

- Select the tracks to record using the corresponding TRACK SELECT KEYS. The tracks in "record" mode are displayed with the letter "R". The symbol ♪ indicates the tracks already recorded, the symbol - indicates the empty tracks. You can deactivate the tracks set to "record" mode by pressing the corresponding TRACK SELECT KEYS again.
- Press ENTER to confirm the track selection (or EXIT to escape from "record" mode). The dialogue window now closes.

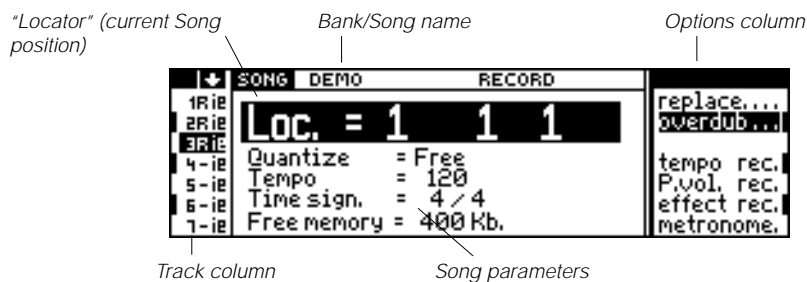

- Select the parameters of the Song and/or tracks, and programme them as required.

quantize Quantization or auto-correction of imperfectly recorded tracks.

Default: Free. Value range: Free, 1/4 ... 1/96.

tempo Starting tempo of the Song.

time signature Division of the bar. This parameter cannot be modified after the Song has been recorded.

Default: 4/4. Value range: 1/2 ... 15/16.

free memory A non-modifiable indicator showing the current space available for the Song being recorded. The maximum space available for a Song is 400 kb.

5. Select the recording options.

replace/overdub Replace cancels existing events and replaces them with those you are recording. Overdub adds the new events recorded to existing events.

tempo record Records Tempo variations (carried out with "Clock" directly by the Music Processor; the Tempo variations received via MIDI cannot be recorded).

pedal volume record (S2/S3) Records Volume variations effected with the Volume Pedal.

common volume record (S2R) As above, but only for variations received via MIDI-COMMON. S2R does not record Volume variations effected with a pedal connected to the PEDAL VOLUME SOCKET.

effect record Records changes of Effects and Effect Volumes introduced with the User Keys and User Sliders (S2/S3), or received via MIDI such as MIDI CONTROLLER 21-24.

metronome Activates/deactivates the metronome during recording tasks.

6. If necessary, you can select the "Locator" to select any starting position of the Song by rotating the DIAL. You can start recording from the first bar, from an existing bar or from the bar immediately following the last bar recorded.
7. Press PLAY to start the recording. The "Locator" shows a count down for two bars before recording, beating in time if the "Metronome" is activated.

Loc. = -1 4 ---

Start playing when the "Locator" shows the position required. The Song starts at position 1-1-1.

8. Stop recording by pressing STOP. You can escape from "record" mode or repeat the recording either in OVERDUB or REPLACE modes.

Note: You can end the Song automatically by programming an "end bar" in the Utility editor (EDIT STOP TO BAR parameter) of EDIT SONG.

9. You can escape from "record" mode by pressing the RECORD button. The button stops flashing.

Note: The Song and its Performance Bank will be lost if you switch off your instrument. Save the Bank/Song to a floppy disk or Ram-disk for future use.

"Undo"

Any recording operation can be cancelled simply by pressing UNDO immediately after the operation. You can, for example, cancel the recording of a badly recorded track.

Press UNDO again to restore an UNDO operation.

Notes and suggestions

Recording a Song If you record a song from the keyboard, remember to check that the tracks in record mode are connected to the Local Source (in EDIT PERFORMANCE/TRACKS, page 1). If you want to record several tracks simultaneously, check that the Local Source is not set to SINGLE, otherwise you will record only one track.

Recording via MIDI When you exchange a Song between two sequencers remember to synchronise their Clocks. The recording Start and Play command must be controlled by only one sequencer so that the start is perfectly synchronised. The Clock of the controlling sequencer must be on “Internal”, while the Clock of the controlled sequencer must be on “External”.

If you use the Music Processor to record a Song that has been created with another sequencer, all the Performance tracks must be set to “record” mode so that the entire Song can be transferred with one operation.

Metronome During Play and Record, the leds of the << and >> buttons act as a visual metronome. The led of << flashes at the first beat of a bar while the led of >> flashes the remaining beats of the bar.

The ‘click’ is not sent to the Midi Out.

Song Position Pointer / Clock Resolution The S Series transmits and receives the Song Position Pointer precisely. This message stops, moves forwards or backwards and starts the Song in precise positions at the minimum resolution of the Midi Clock (24 bpq, exactly one quarter of the Clock resolution of the S Series).

Chase Events or True Events The S Series Sequencer recognises the status of the ProgramChanges and Midi Controllers during a fast forward or fast rewind operation. If, for example, you press >>, the Volume is adjusted to the value of the arrival point, even if the Volume event was not actually performed by the Sequencer.

This system is often called Chase Events (Cubase and Notator Logic) or True Events (Notator).

Songs with different Time Signatures Use the “Insert” function to create Songs with different Time Signatures. Before you start recording, create a “basic structure” of bars with Insert: (a) insert the first group of bars with the initial Time Signature, (b) insert the second group of bars with the second Time Signature, (c) insert the remaining groups of bars with different Time Signatures, (d) record the Song; the Time Signature changes automatically during recording.

The Structure of a Song The following table shows how a Song is structured

MasterTrack	TEMPO	PEDAL VOLUME	EFFECT CHANGE	
	PERF. CH.	PERF. CH.	PERF. CH.	PERF. CH.
Track 1	Analog_1			Tot_Horn_2
Track 2	Mooog_Wv	Arp_260000		SoftSax
Track 3	GrandPiano1	GrandPiano		GrandPiano
Track 4		SoundTrack1		SoundTrack1
Track 5		Dyn_ElGuit		
Track 6	Dyn_Bass			
Track 7	Fretless_B	Ac_Bass		Fretless_B
Track 8				
Track 9	Door			
Track 10	Drum_kit1		Strings 1	
Track 11			Strings 2	Strings 2
Track 12			Synth Strings	
Track 13			Choir	
Track 14			Analog_Pad	
Track 15				APPLAUSE
Track 16	BIRDS			BIRDS

■ Used Track
 ■ Unused Track

9 EDIT Song mode

Accessing Edit Song mode

You can gain access to EDIT SONG in the following manner:

1. Press song in the Edit section. This may open the Playback display or the EDIT SONG environment.
2. If the Playback display appears, select "Edit".

The main menu editors of edit song

Erase events	Cancels the currently specified MIDI events.
Move events	Moves all the MIDI events from one section of the track to another.
Insert/delete bars	Inserts or deletes the number of bars specified.
Dynamic	Modifies the Key On Velocity.
Transpose	Transposes one note or a vertical range of notes.
Quantize	Quantizes a note or a vertical range of notes.
Copy	Copies a section of a track or all the tracks to different position.
Microscope	"Microscopic" Edit of each single event of the track.
Utility	Sets the recording and playback functions.
Mastertrack	"Microscopic Edit" of the Mastertrack (a "ghost" track that contains the Tempo variations, volume variations and the Performance and Effects variations).

Options of the main menu of EDIT SONG

Rec/Play	Opens the Playback display, where you can enter Record mode. The Playback display and the EDIT SONG environment are "superimposed" and simultaneously active; one environment is recalled from the other (s. figure at the foot of the page).
Erase Song	Cancels the Song.

Options of the secondary menus

Menu	Returns to the main menu.
Rec/Play	Opens the Playback display.
Execute	Executes the specific operation of the display or page (e.g. quantize or copy), after assigning values to the various parameters.

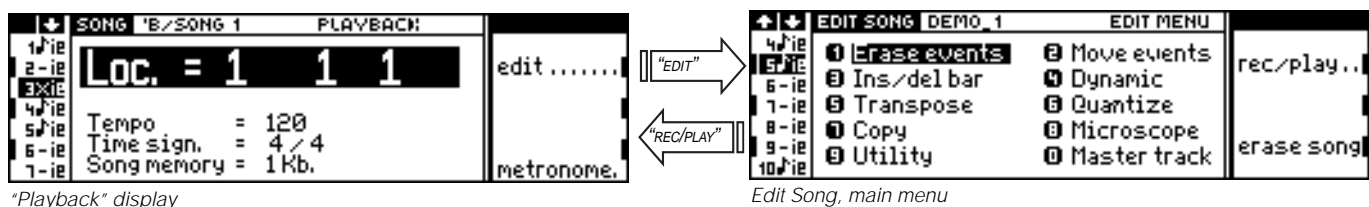

Selecting the Tracks in Edit

All the operations are carried out on the currently selected track. You can select a different track at any time, without escaping from the current edit page. The track is displayed on the first line of the display.

Selection Screen

The selection of the events to be edited takes place on two axes; a vertical axis (note height) and a horizontal axis (position of the Song, in the form Bars-Quarters-Tic).

The expressions used in the edit pages are “Note range” for the vertical axis and “From locator... to locator...” for the horizontal axis:

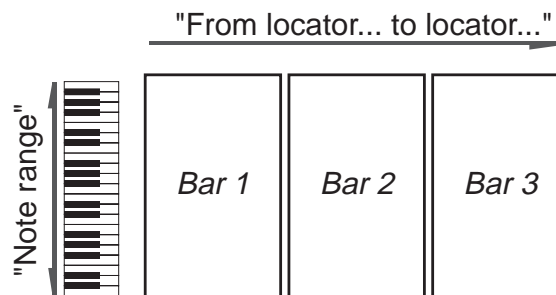

“Execute”

This command appears in many secondary menus; it must be selected to confirm and apply the modifications.

“Undo”

Most edit operations can be annulled by pressing UNDO immediately after the operation.

Press UNDO again to restore the cancelled modifications.

Erase events

This operation erases all MIDI events of a specified type from a specified range of bars. You can perform this operation on the currently selected Track (page 1) as well as the Master Track (page 2).

Page 1: Erase from track

Event	Determines type of MIDI event to erase from the specified locator range. You can also cancel Duplicate notes (the note with the lowest dynamic value is cancelled). Default: All. Value range: Duplicate note, All, Note, PitchBend, Mono touch, Poly touch, Dynamic release (Key Off Velocity), ProgramChange, Midi Controller 0 ... 127.
Note range from... to...	Determines the range of notes which will be affected by the Erase procedure. To select one note only, enter the same value in "from" and "to".
From locator.....	
.....To locator	Determines the Locator range (start and end) from which the specified events will be erased..

Page 2: Erase from Master Track

Event	Determines the type of event to cancel from the specified locator range. Default: All. Value range: All, Tempo, Perf, Volume, Eff. 1/Eff.2, Eff.1 volume/Eff.2 volume, Rotary slow/fast, Scale.
From locator.....	
.....To locator	Determines the Locator range (start and end) from which the specified events will be erased. Note: It is not possible to cancel the starting events of the Master Track (Tempo, Performance, Volume) - they can, however, be modified.

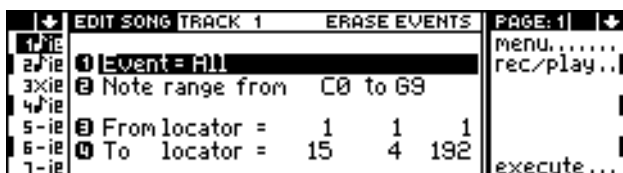

Page 1: Erase from track

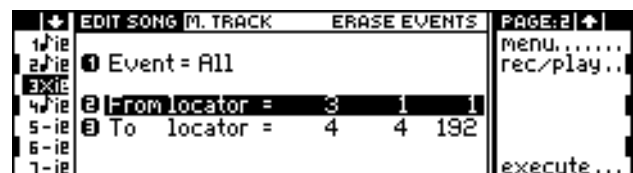

Page 2: Erase from Master Track

Move events

This operation moves *all* the events within a specified locator range in a track to a specified destination Locator. The data occupying the range being moved are completely erased. The data being moved merges with the data, if any, at the destination locator.

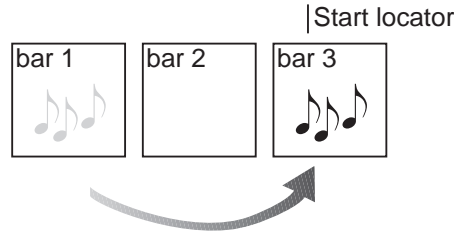

Move from track

From locator.....

.....To locator Determines the Locator range (start and end) from which the specified events will be moved.

Start locator Determines the starting point of the destination.

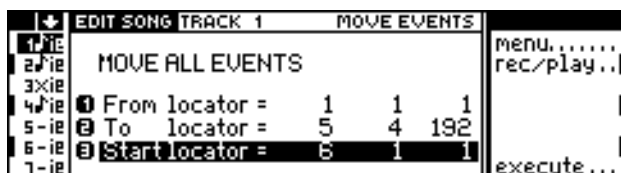

MOVE EVENTS Editor

Insert/delete bars

This operation **inserts** a specified number of empty bars of a specified Time Signature into all the recorded tracks at the specified starting point (page 1), OR, **deletes** a specified number of bars from all the tracks of the Song (page 2).

“Insert bars” procedure:

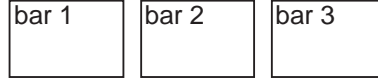

Insert two bars starting from bar 2.

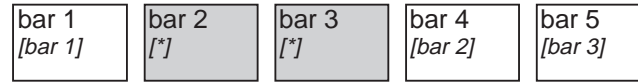

The two new bars are inserted, and the existing bars are moved forwards.

Delete bars” procedure:

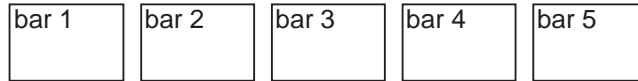

Cancel bars 2 and 3.

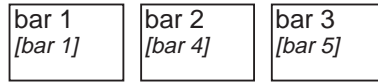

The bars after the cancelled bars are moved backwards.

Page 1: Insert bars

Number of bars	Defines the number of bars to insert.
Bar time	Specifies the Time Signature of the bars being inserted - this value can differ from the rest of the recorded Song. Suggestion: Use “Insert bars” to record a Song containing different Time Signatures.
From bar	Determines where the additional bars will be inserted. All existing bars that follows those being inserted are moved forwards.

Page 2: Delete bars

Number of bars	Determines the number of bars to cancel.
From bar	Indicates the first bar of those to cancel.

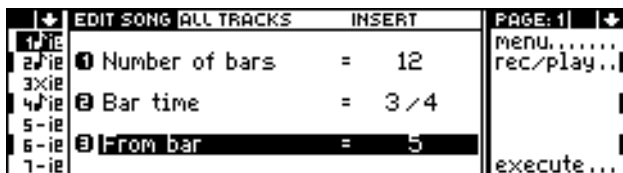

Pagina 1: Insert bars

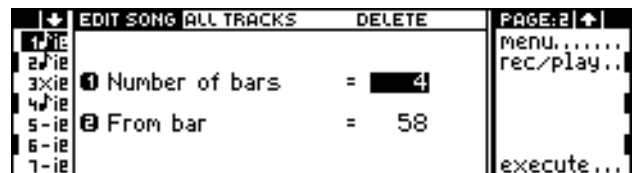

Pagina 2: Delete bars

Dynamic

This is a great option if, for example, you want to open the Filters of a sound that is sensitive to dynamic variations, otherwise not possible unless you repeat the recording with the modified Sound.

This operation modifies the Note on Dynamic values (keystroke velocities) for all note events within the specified bars of the currently selected track.

There are two ways of correcting the values:

- Normal adds or subtracts the specified value indicated in the *Change velocity* parameter to the notes.
- Fixed modifies all the recorded Dynamic values to the specified value indicated in the *Change velocity* parameter.

Dynamic	
Dynamic mode	Selects the mode (Normal or Fixed).
Change velocity	Indicates the amount by which the dynamic values can be modified.
Note range from... to...	Determines the range of notes which will be affected by the Dynamic procedure. To select one note only, enter the same value in "from" and "to".
From locator....	
.....To locator	Determines the Locator range (start and end) within which the modification is to be effected.

Transpose

This operation transposes all single notes or a range of notes by a specified interval.

Transpose	
Transpose	Determines the transposition interval expressed in semitones. Value range: -64... 0... + 64.
Note range from... to....	Sets the lowest and highest limits of the range of notes to be transposed. To select one note only, assign the same value to "from..." and "to...".
	Suggestion: Select one note only to substitute a drum instrument (assigned to a note) with another (assigned to another note).
From locator....	
....To locator	Determines the Locator range (start and end) within which the transposition is to be effected.

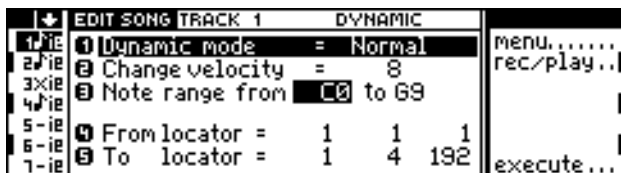

DYNAMIC Editor

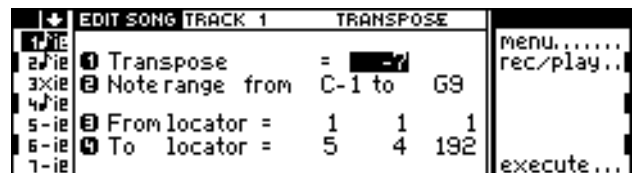

TRANSPOSE Editor

Quantize

This operation adjusts the timing of each event to the nearest interval (quantisation) of the specified value. You can quantize the *Note on* events (the attack phase) as well as those relating to *Note off* (the release phase, hence the duration of the note [Gate time]).

The Quantize procedure is not destructive. You can select a different Quantize value also on a Song already saved and loaded from disk.

Key On Quantize

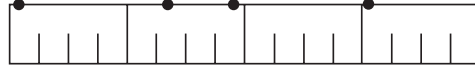

Key On not quantized ('Free').

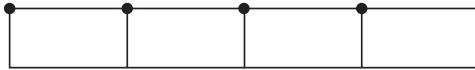

Key On quantized at 1/4.

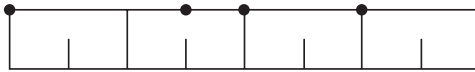

Key On quantized at 1/8.

Key Off Quantize:



Key Off not quantized ('Free').



Key On quantized at 1/4, Key Off not quantized ('Free').

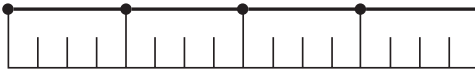

Key On and Key Off quantized at 1/4.

Page 1: Quantize Key On

Note 'On' quantize

Determines the Key On Quantize value. Triplets are also included in the values:

1/2	1/4	1/8	1/16	1/24	1/48
1/3	1/6	1/12	1/24	1/32	1/64

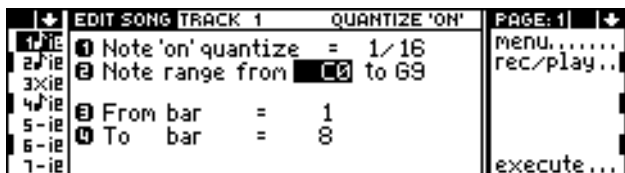

Page 1: Quantize Key On

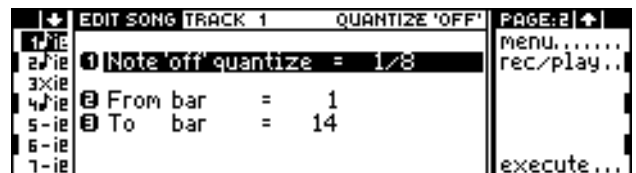

Page 2: Quantize Key Off

Default: Free (no correction). Value range: 1/4, 1/8, 1/12, 1/16, 1/12, 1/32, 1/48, 1/64, 1/96 and Free. "Free" returns tracks precisely to their real time recorded status, cancelling the Quantize value used (if any).

Note range from... to... Determines the range of notes which will be affected by the Quantize procedure. To select one note only, enter the same value in "from" and "to".

From bar....

....To bar Determines the range of bars (start and end) which will be affected by the Quantize Note On procedure.

Page 2: Quantize Key Off

Note 'Off' quantize Determines the Key Off Quantize value.
Default: Free (no correction). Value range: 1/4, 1/8, 1/12, 1/16, 1/12, 1/32, 1/48, 1/64, 1/96 and Free..

From bar....

....To bar Determines the range of bars (start and end) which will be affected by the Quantize Note Off procedure.

Copy

Contains the procedures for copying a portion of a single track, copying a portion of all tracks and the **Append** function.

Append copies an entire Song to the "tail" of the Song currently in edit. It doesn't copy the source Song's original Performances, therefore the copied part makes use of the Performances belonging to the Song currently in edit.

Copy does not destroy the source data, but data at the destination can be destroyed. A copy can be carried out once or several times:



Copy once

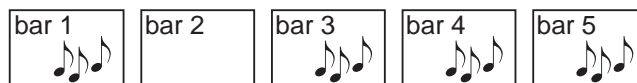

Copy 3 times.

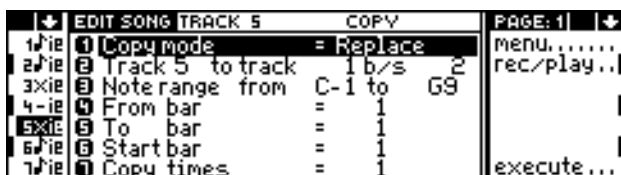

Page 1: Copy from single track

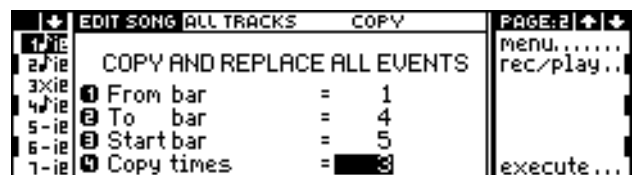

Page 2: Copy from all tracks

Page 1: Copy from single track

	The data to copy are taken from a single track (the currently selected track shown in the track column).
Copy mode	Provides two copying alternatives. Replace: the copied data substitutes the data already present at destination. Merge: the copied data is combined with the data already present at destination. You can use this application to copy, for example, a pattern of bongo drums from one track to a pattern of toms and snare on another track..
Copy track... to track... b/s...	Source track to copy from, destination track to copy to and the destination Bank/Song. The source track is the one shown currently selected in the track column, the destination track must be specified. You can select a Song destination that differs to the one currently in edit: if the specified Bank/Song is non existent, it will be created by the copy procedure.
Note range from... to...	Range of notes to be copied. To copy a single note only, assign the same value to "from..." and "to...".
From bar... to bar...	First and last bar of the portion to copy.
Start bar	First bar of the destination of the copy.
Copy times	Determines the number of times the copy can be repeated. Each copy "tags" on to the previous copy.

Page 2: Copy all tracks

	Copies a portion of all the Tracks of the Song. Careful! This operation copies to the destination in Replace mode only - all data already present at the destination will be cancelled by the incoming copy.
From bar... to bar...	First and last bar of the portion to copy.
Start bar	First bar of the destination of the copy.
Copy times	Determines the number of times the copy can be repeated. Each copy "tags" on to the previous copy.

Page 3: Append

Append Song number...	Select the Song that can be copied to the tail (coda) of the Song currently in edit. The first bar of the copied Song is attached to the last bar of the Song in edit. <div style="background-color: #e0e0e0; padding: 5px;"> <p>Suggestion: Enter the Mastertrack and reassign the Performances to the part added to the Song. The current Performance changes present in the Mastertrack probably recall unsatisfactory Performances, valid for the Performances of the source Bank but not for those belonging to the Bank/Song currently in edit.</p> </div>
-----------------------	--

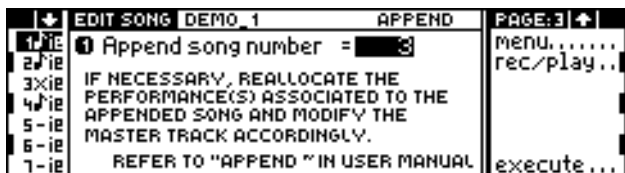

Pagina 3: Append

Microscope

The Microscope operations permit you to edit every event recorded in the currently selected Track. It also permits the insertion of new events without actually playing them on the keyboard, by means of the Insert function.

The events recorded in the track are shown in the Event List shown at the centre of the display.

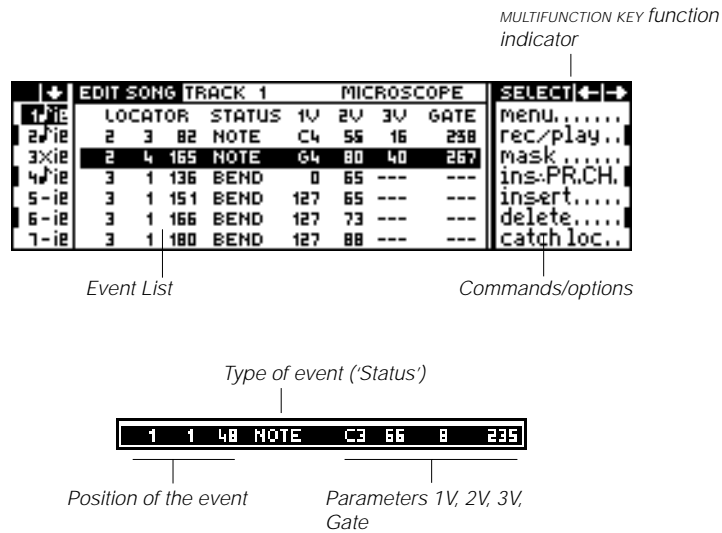

Accessing the events of the Event List and their parameters

1. Select the track whose events you want to display in the Event List.
2. Scroll the Event List with the DIAL. As the notes are selected they are played so that you can check them immediately.
3. Enter the parameters of the event selected with the MULTIFUNCTION KEYS:



Note Event, Modifies parameter 1V.



Note event, Modifies the parameter Locator

4. Modify the parameter value with the DIAL or the NUMERIC KEYPAD.
5. Escape from the event edit mode with ENTER (or EXIT to cancel the modifications). At this point you can select another event and repeat the edit procedure.

Moving to a specified bar

If there is no event in edit, you can go directly to a bar by specifying its number on the NUMERIC KEYPAD.

1. If necessary, escape from the edit of the event currently being edited (by pressing ENTER or EXIT).

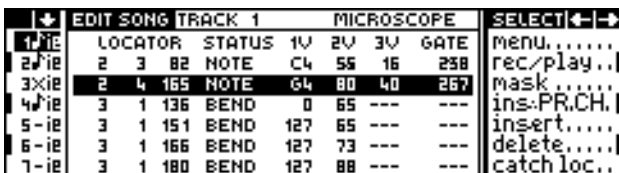

MICROSCOPE Editor

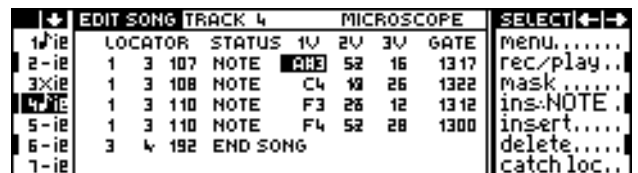

MICROSCOPE Editor in edit

2. Specify the bar number on the NUMERIC KEYPAD and press ENTER to confirm:

GO TO BAR:45

Selecting an event with Catch Locator

You can select an event automatically.

1. Play the Song by pressing PLAY.
2. When you hear the note (or another event) that you want to see displayed, select “Catch Locator” in the command/options column. The event closest to the current Locator of the Song is selected and appears in the Event List.

Programmable Events and Parameters

There are different types of events—indicated in the Status column of the Event List—to which different parameters correspond 1V, 2V, 3V, Gate (“V” means Value). Some parameters may not be accessible for all the different types of events.

Status = Note

1 1 48 NOTE C3 66 8 235

Note.

1v Note name. [C-1 ... G9].

2v Dynamic value (or *Key On Velocity*). [1 ... 127].

3v Release dynamics (or *Key Off Velocity*). [0 ... 127].

gate Note duration. The duration is expressed in “ticks” (q = 192). [0 ... 65535].

Status = ProgramChange

3 2 35 PR.CH. 6 1 --- ---

Program Change (selects the Sound; the value corresponds to the number of the Sound in the Sound Library).

1v First number of the Extended Program Change of the S Series, corresponding to the *Program Change* [0 ... 127] MIDI message.

2v Second number of the Extended Program Change of the S series. This can be recorded only by selecting the Sound from the control panel. During MIDI reception it is replaced by a Bank Select message (Midi Controller 0) [0 ... 127]. This message is sent to the MIDI OUT as *Bank Select*.

Note: If a Program Change of a track and a Performance Change occur at the same point of the Song, the Program Change prevails over the Performance Change and the Sound selected will be the one recalled by the Program Change and not the one programmed in the Performance. The same occurs with Volume events.

Status = ControlChange

3 1 19 CNTR. 1 29 --- ---

Midi Controller messages, (S. the Midi Controllers in the Appendix).

1v Type of Midi Controller (e.g. 0 = Bank Select, 1 = Modulation, 7 = Main Volume...).

2v Midi Controller value.

Status = Bend

2 1 56 BEND 127 65 --- ---

Pitch Bend.

1v LSB value (Least Significant Byte) of the Pitch Bend.

2v MSB value (Most Significant Byte). Actual bending value. [0 ... 63 = pitch down; 64 = neutral position; 65 ... 127 = pitch up].

Status = Mono touch

5 1 9 M.TCH 61 --- ---

Monophonic Aftertouch (or *channel touch*).

1v Aftertouch intensity. [0 ... 127].

Status = Poly touch

4 1 189 P.TCH 03 5 --- ---

Polyphonic Aftertouch (applied to a specific note).

1v Note to which aftertouch is applied. [C-1 ... G9].

2v Aftertouch intensity. [0 ... 127].

The Command/Options Column

The command/options of Microscope are different to those of the other modes.

Commands/options

Menu Returns to the main menu of EDIT SONG.

Rec/Play Opens the Playback display (from which you can enter Record).

Mask Opens a window where you can select the events to view in the Event List.

1. Select the command. The selection window appears:

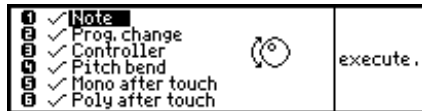

The events shown in the Event List are marked by a "tick" (✓).

2. Select the events to mask in the Event List. Press ENTER to confirm (the sign next to the event disappears).
 3. Select all the other types of events you wish to conceal in the Event List in the same way. Follow the same steps to make the sign reappear next to the events that you wish to view.
 4. Press "Execute" to confirm and close the window.
-

Ins: (x) Specifies the type of event to insert manually with INSERT.

1. Select the command Ins: (x). A window with a list of the events to insert, appears:



2. Select the type of event to insert with DIAL + ENTER or with the NUMERIC KEYPAD. Your entry is confirmed and the window closes. The event code appears next to the command "Ins":

ins:PR.CH.

Insert Inserts an event of the type indicated in the "Ins" command at the selected Locator.

1. Select an event in the Event List whose Locator is closest to the position in which you want to insert the new event.
 2. Select the "Insert" command. The new event (with default values) is inserted immediately before the currently selected event
 3. Modify the Locator of the new event in order to position it correctly.
 4. Modify the values of the event.
-

Delete Cancels the event selected.

1. Select the event to cancel in the Event List.
 2. Press the "Delete" command.
-

Catch locator Selects the event which is currently playing, or the event immediately after the current Locator.

1. Let the sequencer play.
 2. While the required event is playing, press "Catch locator". The event will now appear in the Event List.
-

“Undo”

If you have modified a series of events, you can press UNDO to restore them to their original value. Press UNDO again to recover the modifications cancelled with undo. This is an excellent means of comparing the “previous” and “new” status.

Utility

Contains some useful Song controlling functions.

Utility

Metronome volume	Volume of the metronome. Default: 90. Value range: 40 ... 127.
Countdown	Activates/deactivates a “lead” of two bars before the recording. Default: On. Value range: On, Off (---).
Song loop	Activates/deactivates the “song loop”. This function makes the Song start from the beginning when it reaches the end. Default: On. Value range: On, Off (---).
Edit stop to bar	Activates/deactivates and programmes a compulsory stop bar for the Song at any point before the actual last bar. Default: Off (---). Value range: Any bar of the Song, Off (---). Suggestion: This parameter can be used to set the exact ending point of a recording.
Undo	Activates/deactivates the “Undo” function, activated by the “undo” button. This function consumes a great deal of memory, and may reduce the space available for your Song quite considerably. Default: On. Value range: On, Off (---).

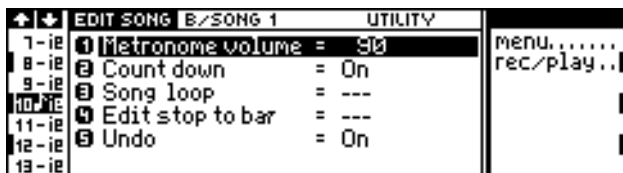

UTILITY Editor

Master Track

The Master Track editor allows you to modify the value and position of each event recorded in the Master Track - the “ghost” track where the events recorded can be Performance changes, Effect and Scale changes, the Volume variations performed with the Volume Pedal (S2/S3) or the Common Volume (S2R), the Effect Volume and Tempo changes, the Rotary control.

It operates in a very similar way to Microscope.

The events recorded in the Master Track are shown in the Event List at the centre of the display:

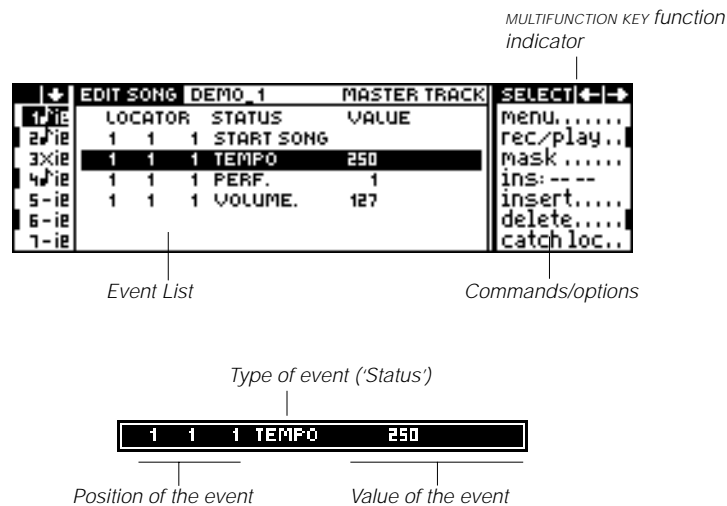

Accessing the events on the Event List and their values

1. Scroll the events in the Event List by rotating the DIAL.
2. Access the parameters of the event selected (Locator, Value) with the MULTIFUNCTION KEYS:

3	1	1	PERF.	E
---	---	---	-------	---

Performance event, Modifies the Value.

3	1	1	PERF.	2
---	---	---	-------	---

Performance event, Modifies the Locator

3. Modify the value of the parameter with DIAL or on the NUMERIC KEYPAD.
4. Escape from the event edit mode by pressing ENTER (or EXIT to cancel the modifications). At this point you can select another event and repeat the edit procedure.

Moving to a specified bar

If there is no event in edit, you can go directly to a bar by specifying its number on the NUMERIC KEYPAD.

1. If necessary, escape from the edit of the event currently being edited (by pressing ENTER or EXIT).
2. Specify the bar number on the NUMERIC KEYPAD and press ENTER to confirm:

GO TO BAR:45

Selecting an event with Catch Locator

You can select an event automatically.

1. Play the Song by pressing `PLAY`.
2. When you hear the note (or another event) that you want to see displayed, select "Catch Locator" in the command/options column. The event closest to the current Locator of the Song is selected and appears in the Event List.

Programmable Events and Parameters

The types of events—indicated in the Status column of the Event List—are different, and each one corresponds to a different value.

Note: The Tempo, Performance and Volume events are always present at the Locator 1-1-1. Their respective values can be modified, but not the Locator. It is not possible to cancel these starting events, which represent fundamental elements of the Song.

Status = Tempo	Tempo.
Status = Perf.	Performance.
Status = Volume	Pedal Volume (in S2/S3) or Common Volume (in S2R).
Status = Effect 1	Number of Effect 1.
Status = Eff. 1 Vol	Volume of Effect 1.
Status = Effect 2	Number of Effect 2.
Status = Eff. 2 Vol	Volume of Effect 2.
Status = Rotary s/f	Rotary slow/fast inversion.
Status = Scale	Scale parameter, tuning of the instrument. (S. Edit General).

The Command/Options Column

The command/options of Microscope are different to those of the other modes.

Commands/options

Menu	Returns to the main menu of <code>EDIT SONG</code> .
Rec/Play	Opens the Playback display (from which you can enter Record).
Mask	Opens a window where you can select the events to view in the Event List. <ol style="list-style-type: none"> 1. Select the command. The selection window appears:

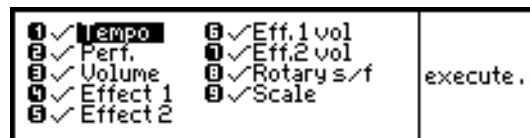

The events shown in the Event List are marked by a "tick" (✓).

2. Select the events to mask in the Event List. Press `ENTER` to confirm (the sign next to the event disappears).
3. Select all the other types of events you wish to conceal in the Event List in the same way. Follow the same steps to make the sign reappear next to the events that you wish to view.
4. Press "Execute" to confirm and close the window.

Ins: (x)

Specifies the type of event to insert manually with INSERT.

1. Select the command Ins: (x). A window with a list of the events which can be inserted appears:



2. Select the type of event to insert with DIAL + ENTER or with the NUMERIC KEYPAD. Your entry is confirmed and the window closes. The event code appears next to the command "Ins":

ins:VOLUM

Insert

Inserts an event of the type indicated in the "Ins" command at the selected Locator.

1. Select an event in the Event List whose Locator is closest to the position in which you want to insert the new event.
2. Select the "Insert" command. The new event (with default values) is inserted immediately before the currently selected event
3. Modify the Locator of the new event in order to position it correctly.
4. Modify the values of the event.

Delete

Cancels the event selected.

1. Select the event to cancel in the Event List.
2. Press the "Delete" command.

Catch locator

Selects the event which is currently playing, or the event immediately after the current Locator.

1. Let the sequencer play.
2. While the required event is playing, press "Catch locator". The event will now appear in the Event List.

"Undo"

If you have modified a series of events, you can press UNDO to restore them to their original value. Press UNDO again to recover the modifications cancelled with UNDO. This is an excellent means of comparing the "previous" and "new" status.

Notes and suggestions

COPY The “Merge” mode, which does not destroy data at the destination, can be exploited to programme the percussion instruments separately then copy all of them to a single track.

APPEND The Append function is used to copy any other Song present in Ram to the “tail” of the Song currently in edit. This can be useful if you want to programme different parts of the Song separately, perhaps to create a Song with different Time signatures. In fact, the copied Song retains its original Time signature, even if it differs to the Song to which it is united.

MICROSCOPE The Event List of the Microscope is a window which looks into the list of events contained in the track. By rotating the DIAL, you can scroll through all the events in the window:

2	1	163	BEND	127	50	---	---
2	2	86	BEND	127	58	---	---
2	2	128	BEND	127	60	---	---
2	2	151	BEND	127	65	---	---
2	3	6	BEND	127	73	---	---
LOCATOR STATUS IV 2V 3V GATE							
2	3	82	NOTE	C4	56	16	258
2	4	165	NOTE	G4	80	40	267
3	1	136	BEND	0	65	---	---
3	1	151	BEND	127	65	---	---
3	1	166	BEND	127	73	---	---
3	1	180	BEND	127	88	---	---
3	1	190	BEND	0	65	---	---
3	2	11	BEND	127	65	---	---
3	2	66	BEND	127	73	---	---
3	2	136	BEND	0	65	---	---
3	2	151	BEND	127	65	---	---
3	2	166	BEND	127	73	---	---

EDIT STOP TO BAR In Record mode, the Locator in the “Record” display can be considered as a *Punch In*, and the parameter “Edit Stop to bar” as a *Punch Out*; these elements define the start and finish of a recording precisely.

UNDO If, while you’re recording, you notice that your free memory is beginning to be a little on the low side too soon, you can stop (at an appropriate point), enter Edit Song, go to the Utility section and disable the song’s Undo buffer. This memory buffer uses up the same amount of memory as the Song as it is being recorded, in order to provide you with the option of “undoing” (cancelling) your recording (you can also undo the undo command and restore the cancelled events).

With the Undo buffer emptied, the reclaimed memory is subtracted from the “Used” read-out and you should be able to finish your song without fear of running out of memory. Naturally, you will no longer be able to exploit the Undo function.

10 EDIT GENERAL

The General section is a Setup; a set of data and settings that influence the way the instrument works. The General section groups together the pitch and tuning settings, the footswitch polarity status, Midi setup, the date and time, the dynamic and aftertouch (S2/S3) sensitivity setting and General Midi compatibility switch.

There is only one General section for the instrument. It can be loaded with the functions of disk after switching on your instrument, or automatically when you switch on the instrument. In both cases it reconfigures the instrument.

Tuning/Scale

Pitch and tuning parameters.

Page 1: Tuning/Scale

Master pitch	Fine pitch of the instrument in steps of 1/64th of a semitone. Default: 0. Value range: -64 ... +64.
Keyboard scale	Keyboard tuning scale. This parameter provides a selection of preset historic scales (temperaments), plus four programmable scales (User scales). You can select this parameter from the Song, with the "Scale" event in the Master Track.

0	Equal Temperamet	1	Pure Major C
2	Pure Major A	3	Mean Tone C
4	Pythagoric C	5	Werckmeister
6	Kimberg	7	Vallotti & Young
8	Invers	9	Chord
10	1/4 Tone	11	Arabian
12	User 1	13	User 2
14	User 3	15	User 4

Note: When Master Transpose is deactivated, the tracks are automatically tuned to the Equal Temperament. S. Edit Performance/Tracks.

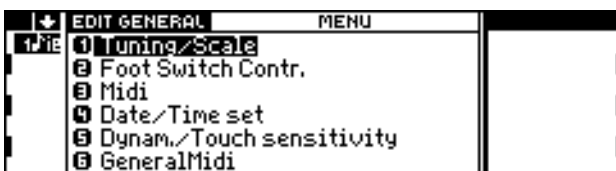

Edit General, Main Menu (S2/S3)

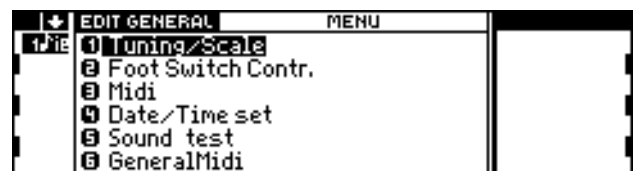

Edit General, Main Menu (S2R)

Page 2: Edit Keyboard Scale

This is where you can programme one of the four User Scales:

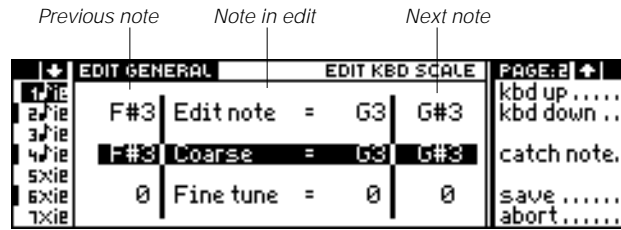

At the centre of the display are the parameters of the note before the one currently in edit, the note in edit and the note immediately after. In fact, this page is a window which looks at three consecutive notes of the keyboard.

Note: You enter EDIT with the currently selected Scale.

EDIT note:	The note of the keyboard.
Coarse	The actual note assigned to the note of the keyboard.
Fine tune:	Fine tune of the assigned pitch of the note expressed in steps of 1/64ths of a semitone. Value range: -63 ... +63.
Command/options	The command/options column contains the following selections:

kbd up Moves up one note at a time. The note after the note in edit becomes the note in edit.

kbd down Moves down one note at a time. The note before the note in edit becomes the note in edit.

catch note Opens a window which prompts you to play the note you want to edit:

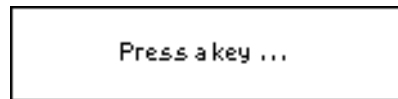

Play the note you wish to edit. *S2R must be controlled via Midi-Common.*

save Saves the Scale in the General Setup. Follow these steps:

1. Select **save**. The following dialogue window appears:

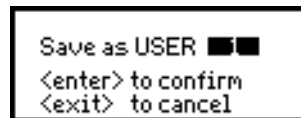

2. Enter one of the four User Scales with the DIAL or on the NUMERIC KEYPAD. If the location is occupied, the previous scale is cancelled or replaced.

3. Press **ENTER** to confirm or **EXIT** to cancel the save procedure.

abort Cancels all the modifications.

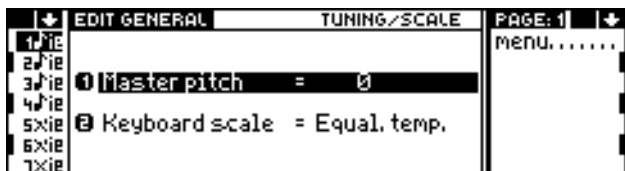

TUNING/SCALE Editor, Page 1

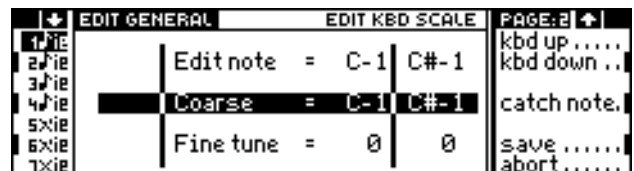

TUNING/SCALE Editor, Page 2

FOOTSWITCH CONTROLS

Here you can define the polarity of the Footswitches and assign them a function. The possibility of programming the polarity of the footswitches allows you to use footswitches of other manufacturers available on the market.

The footswitch polarity can be set either to Normally Open (N.O., open at rest) or Normally Closed (N.C., closed at rest).

The footswitches produced by Generalmusic are N.C footswitches.

This page is not saved in the General Setup, it is memorised in a small battery-backed Ram by selecting "Memorize".

Footswitch 1 polarity	Polarity of Footswitch 1. Default: N.O. Value range: N.C., N.O.
Footswitch 1 control	Function controlled by footswitch 1. The footswitch can operate in any of the following ways: <ul style="list-style-type: none"> • in the mode determined in the Performance, in the second page of EDIT PERFORMANCE/CONTROLS ("Edit Perf. Contr" option); • Performance advance - selection of the successive Performance ("Perf+" option); • selection command of the previous Performance (option "Perf-"); • Start/Stop control of the sequencer ("Start/Stop" option). <p style="background-color: #f0f0f0; padding: 5px;">Note: A Performance advance command ("Perf +") with Performance 10 advances to Performance 1. Pressing "Perf -" when Performance 1 is selected returns you to Performance 10.</p>
Footswitch 2 polarity	As described for "Footswitch 1 polarity", but referring to footswitch 2.
Footswitch 2 control	As described for "Footswitch 2 control", but referring to footswitch 2.

MIDI

This is where you can programme the general MIDI parameters (the individual assignments of the MIDI channels and the MIDI IN and MIDI OUT ports are carried out in EDIT PERFORMANCE/TRACKS).

This page contains the settings of the MIDI-COMMON, MIDI MERGE and CLOCK OUT. It also contains the activation/deactivation of System Exclusive and Extended Program Change.

In the second page you can assign the MIDI channels to each track relating to the instrument as a whole, so that it can transmit/receive on the same settings for all Performances; these settings can override the individual programmings carried out in EDIT PERFORMANCE/TRACKS if the "Midi channel lock" function in the first page is set to "On".

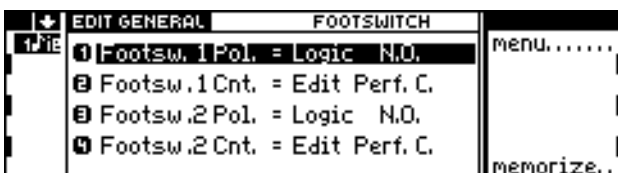

FOOTSWITCH CONTROLS Editor

Page 1: Midi (1)

Midi Common	<p>Activates/Deactivates the MIDI-COMMON, and assigns it a MIDI channel.</p> <hr/> <p>ch The Midi channel assigned to the Midi-Common. This channel cannot be used to control a single track in standard MIDI mode. If it is "Off", the Midi-Common is deactivated. Value range: Off, 1 ... 16.</p> <hr/> <p>in the In port of the MIDI-COMMON channel. If this parameter is set to "---" (Off), the incoming Midi-Common is deactivated. Value range: Off (---), 1, 2.</p> <hr/> <p>out The Out port of the Midi-Common channel. If the parameter is set to "---" (Off), the outgoing Midi-Common is deactivated. Default: 1. Value range: Off (---), 1, 2.</p>
-------------	---

Note: If the MIDI-COMMON is deactivated, the S2R will be deprived of the Local Source. In such a case, you can only control the individual tracks of the expander with a MIDI channel for each track.

Midi Merge	<p>Activates/deactivates the MIDI MERGE function. MIDI MERGE addresses all MIDI signals received at MIDI IN to the MIDI OUT:</p>
------------	--

	<p>(In normal conditions, only the signals generated by the Local Source are directed to the MIDI OUT, while signals from the MIDI IN Source are directed to the internal generation and would then be redirected only to MIDI THRU). Default: Off (---). Value range: On, Off (---).</p>
--	---

System Exclusive Midi filter	<p>Activates/deactivates the transmission and reception of the System Exclusive. When it is "On" this <i>filter</i> prevents the transmission and reception of S.E. Default: On. Value range: On, Off (---).</p>
------------------------------	--

Midi Extended Prog Change	<p>The S Series PROGRAM CHANGE consists of two parts, in the form xxx-yyy:</p> <ul style="list-style-type: none"> • the principal number (part xxx), transmitted as a PROGRAM CHANGE; • the secondary number (part yyy), transmitted as BANK SELECT (or Midi Controller 0). <p>In some cases, the secondary number (<i>Bank Select</i>) may interfere with other data in the receiving device, above all if it is an outdated instrument non capable of receiving <i>Bank Select</i> data, therefore it can be <i>filtered</i> from the Midi data stream in transmission. If the parameter is "Off" the secondary number is <i>filtered</i> and not transmitted. Default: On. Value range: On, Off (---).</p>
---------------------------	---

Clock out	<p>MIDI CLOCK OUT synchronises the Tempo of an instrument connected to the MIDI OUT of the Music Processor with the MIDI CLOCK of the Music Processor. If this parameter is "On", the Tempo is sent to the MIDI OUT and can synchronise the receiving instrument (sequencer, rhythm unit, instrument with automatic accompaniments...) Default: On. Value range: On, Off (---).</p>
-----------	---

Midi channel lock	<p>Assigns the MIDI channels programmed in the next page to the tracks of any Performance, overriding the individual settings of each Performance.</p>
-------------------	--

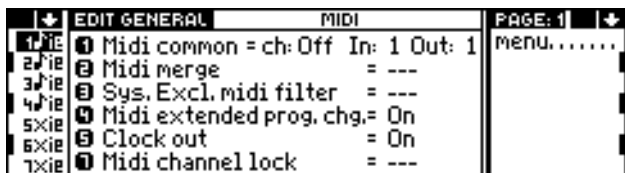

Midi editor, Page 1

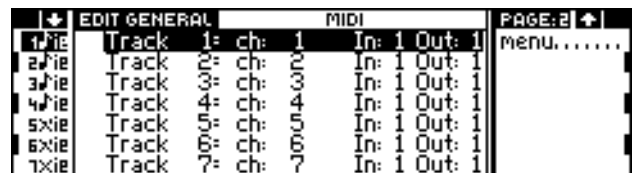

Midi editor, Page 2

Page 2: Midi (2)

Assigning Midi channels to the tracks programmed in this page overrides the programming of each individual Performance if the "Midi Channel lock" function (on the previous page) is set to "On".

Rotate the DIAL to select the track to programme.

ch MIDI Channel assigned to the track.

in MIDI IN Port 1 or 2.

out MIDI OUT Port 1 or 2.

DATE/TIME SET

The S Series has an incorporated clock/calendar which can be displayed by pressing CLOCK. It is used to assign date and time of modification to the files stored on floppy disks.

Date & Time

Date	Current date in European standards (gg-mm-aa).
Time	Current time in the twenty four hour clock cycle (hh-mm-ss).

DYNAMIC/TOUCH SENSITIVITY (s2/s3)

Here you can regulate the dynamic and aftertouch sensitivity of keyboard models and memorise the setting to a buffer memory.

This page is not memorised in the General Setup, it is stored to a small battery-backed Ram by selecting "Memorise".

Sensitivity

Keyboard sensitivity	Regulates the dynamics. The standard value is "3". Higher values render the keyboard the more sensitive to changes in keystrike velocity. Use lower values if you prefer a harder keyboard with less immediate response.
Aftertouch sensitivity	Regulates the aftertouch. The standard value is "3". Higher values correspond to a more sensitive aftertouch; while lower values correspond to a less sensitive aftertouch.

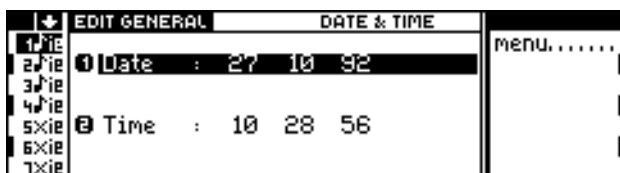

DATE/TIME SET Editor

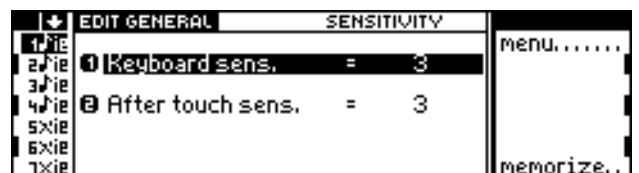

DYNAMIC/TOUCH SENSITIVITY Editor (S2/S3 only)

SOUND TEST (S2R)

Given that S2R does not have a keyboard, and that it is possible to use it without connecting it to a master keyboard or other controlling device, the SOUND TEST allows you to play a note of the currently selected track (in SOUNDS mode).

Press ENTER to play the note in the track selected. The note is also sent to the MIDI OUT, and will trigger a sound from any expanders that are connected. (The track must be connected to the MIDI OUT DESTINATION).

This page is not memorised to the General Setup file, but you can memorise it in a buffer Ram by selecting "Memorize".

Sound test

Note	Note played by pressing ENTER.
Dynamic	Dynamics (Key On Velocity) of the note played.

GENERAL MIDI

General Midi (**GM**) is an addition to the standard Midi protocol which stipulates (*a*) how the Sounds are organised in the Sound Libraries and (*b*) which percussion sounds to use in the Drumkits. The **GS** standard also adds to the **GM** standard the Program Changes required to select the Drumkits.

GM/GS instruments can communicate with one another by selecting similar sounds with the same Program Change (for example, the PrCh 1 always corresponds to the Grand Piano, PrCh 49 always corresponds to Strings...).

Briefly, the GM/GS compatibility standards are as follows:

- similar organisation of the Sound Libraries;
- compatible drumkits;
- drumkits assigned to MIDI channel 10 (generally track 10).

The Sound Library and the Drumkits of the S Series are organised according to General Midi standards, with some minor variations. The Program Changes of the Drumkits, on the other hand, are different and can be rendered compatible if the "General Midi" parameter is set to "On".

This page is not memorised in the General Setup file, but you can memorise it in a battery-backed Ram by selecting "Memorise".

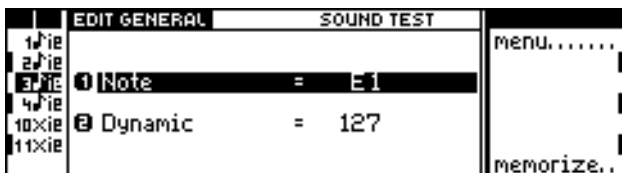

SOUND TEST Editor (S2R only)



GENERALMIDI editor

General Midi

General Midi

Activates/deactivates the compatibility with the GS Program Changes for the selection of the Drumkits. If the compatibility is active, the following situation will be in force:

- during Midi communications, the Music Processor transmits and receives the correct Program Change for the selection of the Drumkits on MIDI channel 10;
- when you save Midi-files, the Music Processor converts the Program Changes of MIDI channel 10 into GS Program Changes.
- when you read Midi-files created in GS standard, the Music Processor converts the Program Changes of MIDI channel 10 into the Program Changes of the S Series Sound Library.

GS STANDARD		S SERIES	
0 ... 7	Standard	121-5	Standard
8 ... 15	Room	122-5	Room Kit
16 ... 23	Power	123-5	Power Kit
24	Electric	124-5	Electric
25 ... 31	TR808	125-5	House Drums
32 ... 39	Jazz	126-5	Jazz Drums
40 ... 47	Brush	127-5	Brush Kit
48 ... 127	Orchestra	128-5	Orchest Kit

Conversion table for Program Changes which travel on Midi channel 10 SerieS <—> GS.

Notes and suggestions

Keyboard Scale The scales included in the S Series Rom are temperaments of historic origin and non-European scales. The following is a list of the scales available.

- (0) **Equal**: Used since the times of Bach to our times.
- (1) **Pure Major C**: Scale based on the formula $F=f+n$, where F is the frequency to calculate, f the previous frequency and n a constant. The calculation starts from the note C.
- (2) **Pure Major A**: Identical to the previous scale, except that the calculation starts from the note A.
- (3) **Mean Tone C**: “Mesotonic” temperament used in the XVIth and XVIIth centuries, calculated from the note C. Favours the perfect major third interval. The chromatic scale is very irregular and the major 3rd intervals **B-D#**, **F#-A#**, **C#-E#**, **Ab-C** are diminished fourths. The diminished sixth interval **G#-Eb** is known as the “fifth of the wolf”. The scales used in the period when this temperament was used are **C major/A minor**, **D major/B minor**, **G major/E minor**, **A major/F# minor**, **Bb major/G minor**.
- (4) **Pythagoric C**: Temperament calculated by the mathematician, physicist and philosopher Pythagoras, in use until the 15th century. It is based on a purely arithmetical calculation of the eighth and the fifth. The scale is calculated starting from C.
- (5) **Werckmeister**: Temperament proposed by the organist Andreas Werckmeister. It is suitable for performing the German musical repertoire between the end of the XVIIth century and the XVIIIth century. The keys with greater alterations appear variously distinctive.
- (6) **Kirnberger**: Temperament proposed by J.P. Kirnberger, pupil of J.S. Bach. This is equally suitable for Bach’s works and the German Baroque repertoire. The keys with greater alterations appear variously distinctive.
- (7) **Vallotti&Young**: This Italian Temperament of Giuseppe Tartini and Francescantonio Vallotti and later revived in England by Thomas Young is used effectively for the Italian XVIIIth century repertoire as well as for the English repertoire of the same period. The keys with greater alterations appear variously distinctive.
- (8) **Invers**: This is an inverted equal temperament. The scale starts from the right instead of the left.
- (9) **Chord**: The notes of a scale belong to different octaves. This temperament can be useful with Strings or Pads Sounds, to fill the overall sound by covering a wider extension.
- (10) **1/4 Tone**: One of the two Arabian scales, where, with respect to the Equal temperament, the notes E and B are flattened by 1/4 of a tone.
- (11) **Arabian**: The second Arabian scale where the notes E and A are flattened by 1/4 of a tone.
- (12..15) **User 1...4**: Programmable scales.

Midi channel lock A general assignment of the Midi channels to the tracks which can be saved in the General Setup. This locks the MIDI assignments for the instrument as a whole, overriding the individual channel settings of each Performance. In this way you can have at your disposal different Midi configurations for different situations (studio setup, concerto setup). It also protects your entire MIDI setup from being destroyed by loading Songs which have complex Midi setups.

11 DISK

The floppy disk and the Ram-disk (if installed) are data storage systems which store data contained in the instrument's Ram. Owing to the fact that Ram is volatile (the contents are cancelled when you switch off your instrument), it is necessary to store your data on disk.

Floppy disks permits the storage and transportation of data, while the Ram-disk provides high speed access to stored data.

The DISK environment - consisting of four pages - contains operations for the exchange of data between the Ram and disk systems (floppy disk and Ram-disk) and disk handling functions (formatting and erase...).

The DISK environment also has functions which allow you to exchange Midi-files with other sequencers.

Automatic loading when powering up

The entire contents of the Ram-disk or a floppy disk can be loaded automatically when you power up your instrument.

(A) Powering up with no disk in the disk drive.

- The entire contents of the Ram-disk are loaded. If the Ram-disk is empty, the instrument powers up with a default configuration. The default display will appear:

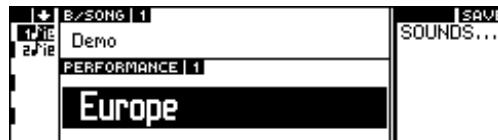

(B) Powering up with a disk inserted in the disk drive.

- The entire contents of the floppy disk are loaded. The display of Performance 1 of Bank/Song 1 contained in the floppy disk will appear.

In order to power up the instrument with a default configuration, even when the Ram-disk contains data, press and hold down ENTER for several seconds immediately after turning on the instrument.



Page 1: Load



Page 2: Save

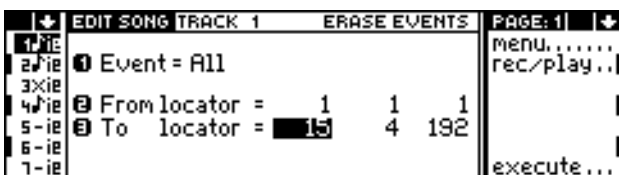

Page 3: Erase



Page 4: Utility

The Ram-disk

Some models of the S Series incorporate 512 kb of static Ram that implement the Ram-disk. All the models in the S Series are designed to be fitted with 512 kb or 2 Mb of static Ram.

The operations that can be performed on the Ram-disk are identical to those that can be carried on a floppy disk.

You can access the Ram-disk in the DISK pages by pressing FUNCTION KEY B:



Ram-disk not installed If the Ram-disk is not installed, any attempt to access the Ram-disk displays the following error message::



The Groups

A Group is a set of 10 Bank/Songs that can be loaded into the memory at the same time.

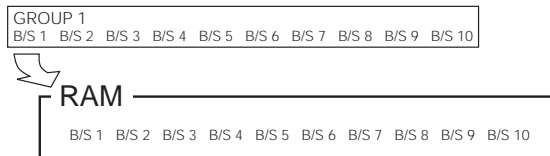
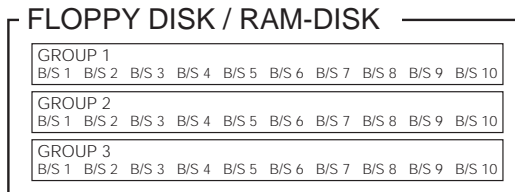

The Group is indicated in the option column by the symbol \square and by the corresponding number. This symbol appears when you select an operation that includes the Bank/Songs (for example, Load All, Load All Bank/Song, Load Single Bank/Song):



Up to 10 Groups can be stored to a disk. Numbering starts from 1 and “0” represents Group 10.

The “Load All” operation loads, among other data, the Bank/Songs of the Group selected.

Accessing the Groups In order to gain access to successive Groups, press the FUNCTION KEY corresponding to the disk (floppy or Ram) repeatedly in the Load, Save and Erase operations. The number of the Group selected appears next to the \square symbol:



Displaying the Groups In the Save operations you can select all the Groups from 1 to 0 (10). In the Load and Erase operations, only the Groups containing at least one Bank/Song are displayed.

For example: if there are Bank/Songs only in Groups 2 and 5, only the numbers 2 - 5 are shown in the relative Load and Erase pages.

Empty groups Empty Groups are identified by an asterisk next to the number:



In these Groups you can carry out a Save All operation without fear of losing any of the Bank/Songs stored previously on the disk.

Organisation of the disk environment

Disk operations are spread over four pages, each containing similar operations (Load, Save, Erase, Utility). The layout of all four pages is similar:

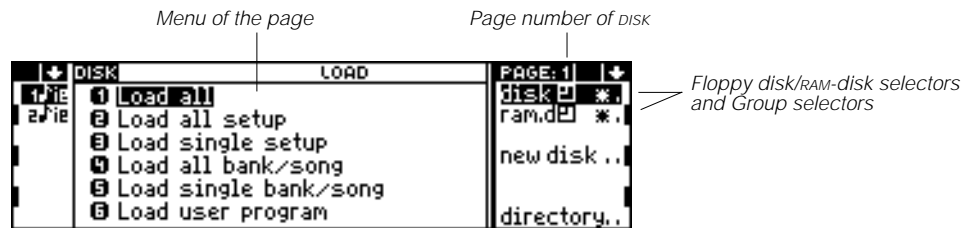

General commands/options

disk/ram.d Selectors for the storage devices (floppy disk or ram-disk) and the Groups. The Group number and an asterisk (*) indicating an empty Group may appear next to the selectors.

number One of the ten Groups contained in the disk. Numbering starts from 1 and "0" represents Group 10. Tap the function key repeatedly to access the various Groups.

asterisk The Group is empty (it does not contain a Bank/Song).

Note: Empty Groups appear only in the Save page (in the Load and Erase pages they are not shown).

New disk Updates the disk directory. It is used when the floppy disk inserted in the disk drive is changed.

Directory Displays the contents (directory) of the device selected. "Directory" allows you to check the contents of disks or the operative Ram. The directory which appears differs according to the type of data selected (All, Bank/Song, Setup). *

General procedure to display the directory:

1. In the Disk page (Load, Save, Erase) select the data whose directory you wish to be displayed. For example, "Bank/Song":



- Select the "Directory" command. The contents of the currently selected device are shown (floppy disk, Ram-disk, operative Ram):

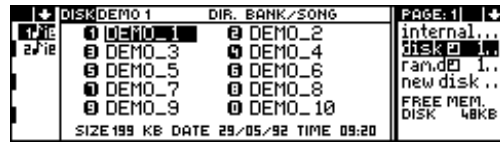

- Escape from the Directory display by pressing EXIT.

*** Directory**

An example of a "Directory" display:

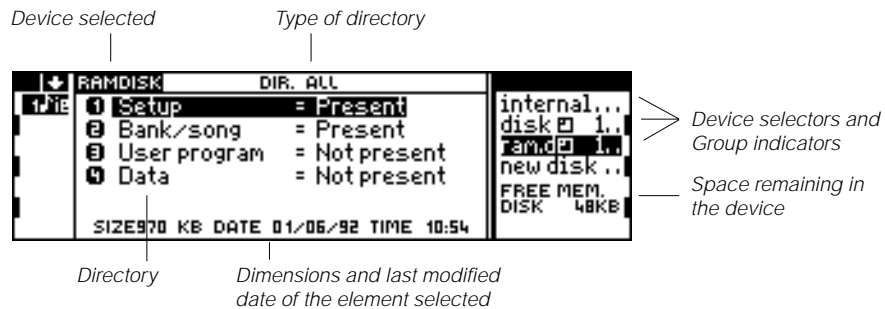

Storage device selectors

Select the devices whose directory you wish to see.

INTERNAL Operative RAM.

disk floppy disk. (You cannot select the Bank/Song Group; in order to select the Group you must first escape from the directory by pressing EXIT).

ramdisk Ram-disk. (You can not select the Bank/Song Group; in order to select the Group you must first escape from the directory by pressing EXIT).

Types of directories

Different Directories will appear (All, Bank/Song, Setup) depending on the type of data selected in the Disk page (Load, Save, Erase pages). For example, if you select "Load All Bank/Song" or "Load Single Bank/Song", the "Bank/Song" directory is displayed. *

dir all Main directory. Shows the presence or absence of the various data.

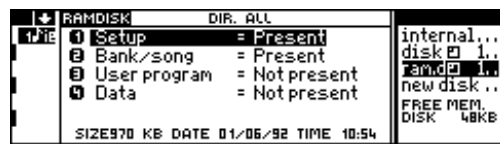

dir setup Displays the presence or absence of the four Setups:

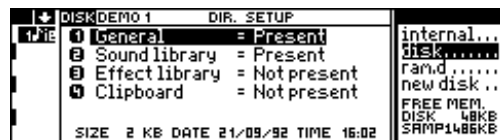

dir bank/song Displays the names of the Bank/Songs stored. (To select a different Group you must escape from the "Directory" display).

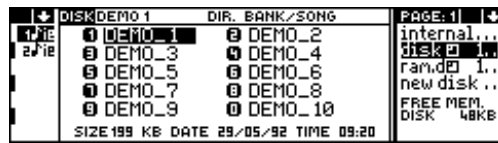

The second page displays the Performances contained in the Bank/Songs highlighted by the cursor:



* Data displayed in the directories

dir all	<p>setup Displays the presence or absence of the Setups: General, Sound Library, Effects Libraries, Clipboard.</p> <p>bank/song Displays the presence or absence of the Bank/Songs stored in memory or in the Group selected.</p> <p>user program Displays the presence or absence of one of the User Programs stored on disk or in memory.</p> <p>data Displays the presence or absence of data generated by a User Program.</p>
dir setup	<p>general General instrument settings.</p> <p>sound library Customised Sound Library, with new Sounds not contained in the standard Rom Sound Library.</p> <p>effects libraries Customised Effects Libraries, different to those contained in the Rom.</p> <p>clipboard Clips from the "Clipboard" page.</p>
dir bank/song	<p>The first page displays the Bank/Songs stored in memory or on disk. The second page displays the Performances in the Bank/Song highlighted by the cursor in the first page.</p>

The Disk environment pages (Load, Save, Erase, Utility)

The DISK environment consists of four pages (Load, Save, Erase, Utility), each with similar functions.

Load

Commands/options Standard commands/options (disk, ramdisk, new disk, directory).

Load all Loads the entire contents of the disk. Loads the Bank/Songs of the Group selected.

Important: the contents of the memory will be cancelled and replaced by the data being loaded.

Load all setup Loads all the Setups (General, Sound Library, Effects Libraries, Clipboard).

Load single setup Loads one of the Setups.

1. Select "Load single setup". The directory of the Setups on the disk selected is displayed

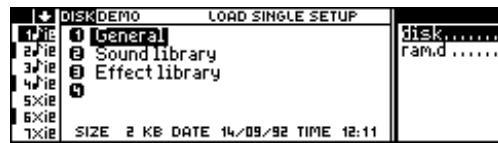

"Load single setup". In this disk the Clipboard is not present.

2. Select the Setup to load and confirm the operation.

Important: Loading a Setup from disk modifies the instrument's operating mode. For example, the General Setup can alter the MIDI-COMMON status, a Sound Library may change the Sounds used by the tracks.

Load all bank/song Loads all the Bank/Songs of the Group selected.

Load single bank/song Loads one of the Bank/Songs of the Group selected.

1. Select the "Load single bank/song" procedure. The directory of the Bank/Songs contained in the currently selected Group is displayed. (You can press EXIT to interrupt the operation, and then select a different Group to repeat the operation).

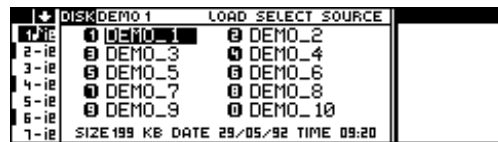

"Load — select source". Directory of the Bank/Songs included in the selected Group (on disk).

2. Select the Bank/Song to load and confirm. The directory of the Bank/Songs in memory is displayed:

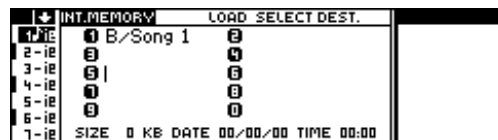

"Load — select destination". Directory of the Bank/Songs present in memory.

3. Select the Bank/Song destination and confirm.

Important: The Bank/Song occupying the location (if any) will be replaced by the incoming Bank/Song.

Load User Program Loads one of the User Programs on the floppy disk.

1. Select "Load User Program". The directory of the User Programs on the floppy disk is displayed.
2. Select the User Program to load and confirm.

Save

Commands/options The standard commands/options (disk, ramdisk, new disk, directory) also include the option "S.compr." (= *Sample compression*).

s. **compr.** Compresses the samples during the Save procedure. A compressed sample occupies less space on the disk, meaning that the 2 Megabytes of Sample-Ram can be stored on one floppy disk.

Note: Compressed samples are decompressed automatically during the Load procedure.

Save all Saves the entire contents of the memory. The Bank/Songs are saved in the selected Group.

Important: The data being saved will erase the contents on disk. (The Groups not selected remain unaltered).

Save all setup Saves all the Setups present in memory (General, Sound Library, Effects Libraries, Clipboard) and replaces those stored on the disk.

Save single setup Saves one of the Setups in memory and replaces the one stored on disk.

1. Select "Save single setup". The directory of the Setups in the memory is displayed:

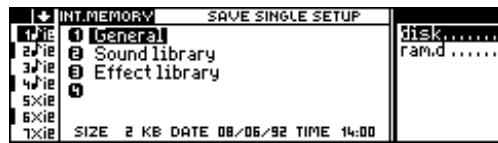

"Save single setup". The example given shows no Clipboard in the memory.

2. Select the Setup to save and confirm the operation.

Save all bank/song Saves all the Bank/Songs of the Group selected. If the Group selected is empty (marked by an asterisk: *) it is created automatically.

Save single bank/song Saves one of the Bank/Songs in the memory in the Group selected. If the Group selected is empty it is created automatically.

1. Select "Save single bank/song". The directory of the Bank/Songs in the memory is displayed.



"Save — select source". Directory of the Bank/Song present in memory .

2. Select the Bank/Songs to save, and confirm. The directory of the Bank/Songs contained in the Group selected on the disk is displayed (you can interrupt the operation by pressing EXIT, select another Group and repeat the operation):



"Save— select destination". Directory of the Bank/Song included in the Group selected (on disk).

3. Select location in which to save the Bank/Song and confirm.

Important: The Bank/Song occupying the location (of any) will be replaced by the Bank/Song being saved.

Erase

Command/options Standard commands/options (disk, ramdisk, new disk, directory).

Erase all Cancels the entire contents of the disk.

Erase all setup Cancels all the Setups (General, Sound Library, Effects Libraries, Clipboard).

Erase single setup Cancels one of the Setups.

1. Select "Erase single setup". The directory of the Setups in the disk selected is displayed:

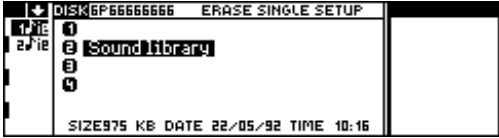

"Erase single setup". In this disk only the Sound Library is present.

2. Select the Setup to cancel and confirm the operation.

Erase all bank/song Cancels all the Bank/Songs of the Group selected.

Erase single bank/song Cancels one of the Bank/Songs of the Group selected.

1. Select "Erase single bank/song". The directory of the Bank/Songs in the Group selected is shown. (If necessary, you can press EXIT to interrupt the procedure and then select a different Group to repeat the operation).

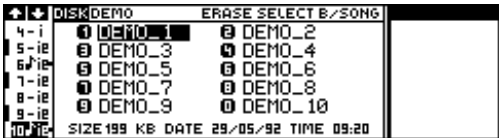

"Erase— select Bank/Song". Directory of the Bank/Songs included in the Group selected (on disk).

2. Select the Bank/Song to cancel and confirm.

Erase all B/S groups Cancels all the Groups of the Bank/Song on the disk.

Utility

Format work disk (1.62 Mb) Formats a 3.5" HD floppy disk in the standard S Series format (to memorise Songs, Performances, Sounds). The operation is a force-formatting procedure which formats the disk to a capacity of 1.62 Megabytes (1591 Kb effectively available).

1. Select "Format work disk (1.62 Mb)":



"Insert a floppy disk of the HD type"

2. Insert the unprotected floppy disk and confirm. Previously used floppies are reformatted.



The flashing cursor shows the position of the first entry

3. Enter a name for the disk. This step is optional but you are strongly recommended to name all your floppy disks to avoid confusing different disks.
4. Confirm the procedure. The formatting procedure lasts about two minutes.

Format Ms-Dos (1.44 Mb) Formats a 3.5" HD floppy disk in Ms-Dos format for the exchanging of Midi-files. The formatted disk has a capacity of 1.44 Megabytes.
The procedure is identical to the one described above.

Format Ms-Dos/Atari (720 Kb) Formats a 3.5" DD floppy disk in Ms-Dos/Atari double density format, for the exchanging of Midi-files. The formatted disk has a capacity of 720 Kb.
The procedure is identical to the one described above (you are however prompted to insert a 3.5" DD floppy disk).

Change disk name Procedure to change the name of a disk.
1. Insert the floppy disk (in "work" format, S Series disk) whose name you want to change.
2. Select "Change disk name".

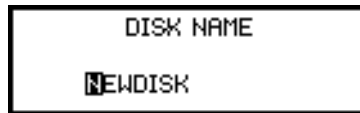

3. Enter the new name and confirm.

Load standard Midi-file Loads a Midi-file from Ms-Dos (3.5" HD) or Ms-Dos/Atari (3,5" DD) floppy disks.

1. Select "Load standard Midi-file".

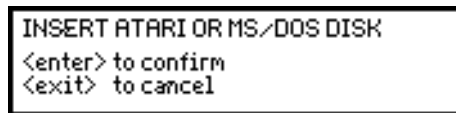

2. Insert the floppy disk and press ENTER. The directory of the MIDI-files on the floppy disk is displayed:

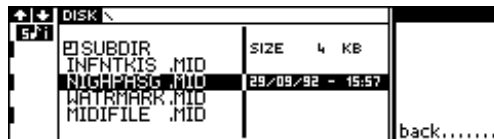

3. Select the ".MID" file to load and confirm . ❄



Directory of the Bank/Songs contained in memory.

4. Select a memory destination for the Midi-file and confirm.
5. The Midi-file is converted into a standard S Series Song. A new Bank with only Performance 1 and standard settings, is created.

❄ The following two elements may appear in the display of an Ms-Dos or Ms-Dos/Atari floppy disk:

symbol '☐' Sub-directory of the floppy disk. This may contain other Midi-files. Access the sub-directory by selecting it and pressing ENTER.

'back' command Returns from a sub-directory to the main directory.

Save standard Midi-file Saves a Song in Midi-file format. You will need a 3,5" HD disk in Ms-Dos format or a 3,5" DD disk in Ms-dos/Atari format.

1. Select "Save standard Midi-file".

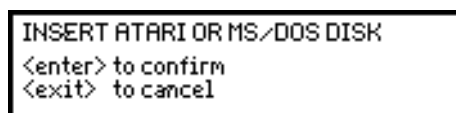

2. Insert the floppy disk and press ENTER. The directory of the Songs in the memory is displayed:



3. Select the Song to convert into a Midi-file and confirm.

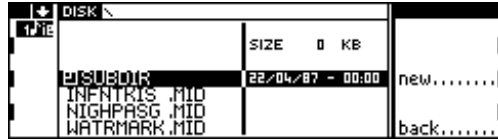

Directory of the Ms-Dos or Ms-Dos/Atari floppy disk.

4. Select "New" to create a new file on the disk:

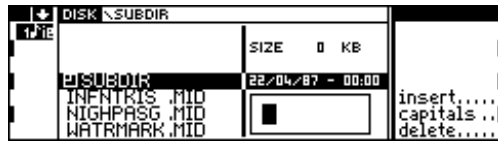





5. Assign a name to the Midi-file and confirm.

Suggestion: Instead of selecting "New", you can select the name of an existing Midi-file and press ENTER. The Midi-file is replaced by a new Midi-file originating from the conversion of the selected Song.

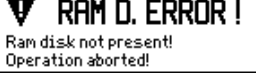

Possible error messages during disk operations

Errors which occur during disk operations may be caused by incorrect procedures, interference with other functions in current use on the instrument (edit of a Sound or Effect), by a bad quality floppy disk or insufficient memory space.



Errors common to all operations

 <p>RAM D. ERROR ! Ram disk not present! Operation aborted!</p>	Ram-disk not installed.
 <p>DISK ERROR ! Disk not inserted! Operation aborted!</p>	Disk not inserted. Insert the floppy disk and repeat the operation.
 <p>STOP! Insert Disk! Operation has been aborted!</p>	The disk was removed during an operation, The operation has been interrupted. Insert the floppy disk and repeat the operation.
 <p>DISK ERROR! MEDIA write protected! Operation has been aborted!!</p>	The disk is protected. Remove the protection and repeat the operation.

Load errors

 <p>ATTENTION ! memory not sufficient! Operation aborted!</p>	Insufficient memory space. It is not possible to complete the procedure.
 <p>STOP! SOUND EDIT is active Save/abort SOUND EDIT!</p>	Sound currently in edit. It is not possible to load a new Sound Library. Escape from Sound Edit.
 <p>STOP! EFFECT EDIT is active Save/abortEFFECT EDIT!</p>	Effect currently in edit. It is not possible to load a new Effect Library. Escape from Effect Edit.

Load and Erase Errors

 <p>ATTENTION ! no setup! Operation aborted!</p>	No Setup is present on the disk.
 <p>ATTENTION ! no bank/song! Operation aborted!</p>	No Bank/Songs are present on the disk.
 <p>ATTENTION ! no user program! Operation aborted!</p>	No User Programs on the disk.

Notes and suggestions

Formats of the magnetic supports used

3,5 HD	1,62 Mb "work disk" format . To save and/or load S Series data (Bank/Song, Setup, User Program).
	1,44 Mb Ms-Dos format. To save and/or load Midi File to exchange with an Ms-dos computer (also Macintosh or Amiga).
3,5 DD	720 kb Ms-Dos/Atari format. To save and/or load Midi Files to exchange with an Atari ST/TT/ Falcon or Ms-Dos computer (also Macintosh or Amiga).

floppy disk write protection You will find instructions for the disk write protection procedure on the disk packing. Floppy disks are protected when the small window in the corner is open; they are unprotected when the tab covers the window:

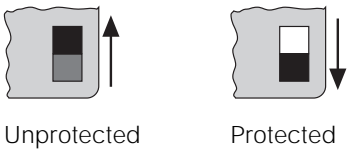

Structure of Ms-Dos Disks Ms-Dos disks are organised in directories and sub-directories. Files can be stored in both the main directory (*root* or *disk*) or in the sub-directories. The following illustration gives an idea of this structure:

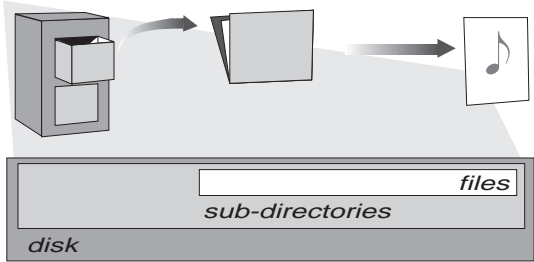

Using Ms-Dos Disks with Macintosh and Amiga Macintosh and Amiga apparatus can read and write on Ms-Dos floppy disks. Apple computers use a programme called Apple File Exchange™, which allows you to read and write files on this type of floppy disk; we recommend the use of more practical programmes, such as AccessPC™, DosMounter™ or PC Exchange™. Commodore computers can read Ms-Dos disks thanks to the programme Dos2Dos™.

Storing floppy disks There are a number of rules to follow to avoid damaging your floppy disks and losing data.

- Keep the disks in a dry, dust-free place which is not subject to extreme temperatures.
- Do not touch the magnetic disk (the part of the disk covered by the metal protection shutter).
- Never remove the disk from the drive while the disk drive led is on.
- Label disks with the name and the data contained.
- Store your disks in the special disk containers available in any computer store.
- Do not layer labels and do not insert your disk in the driver if the label is torn or partially unglued.

Erasing speed Remember that the Erase All operation is always faster than the individual Erase operations. While Erase All cancels the disk directory (FAT), Erase All Bank/Song cancels all the Bank/Songs and relative Performances.

12 SOUND LIBRARY

The Sound Library is where the Sounds are stored. Organised in family groups with a simple “search” system available, finding and selecting Sounds is a simple task.

A Sound Library can be saved and loaded as a Setup-Sound Library. The standard Sound Library has 518 Rom-Sounds. Customised Sound Libraries also include the Ram-Sounds (Sound with the symbol ■).

You can load Ram-Sounds from standard disks available on the market or create them in EDIT SOUND. Thanks to the Sample Translator you can enrich the Sound Library with Sounds containing samples loaded from disk or received via Midi (Ram-Sound with symbol “Ⓜ”).

The Sounds are organised almost completely according to General Midi standards, with the exception of the Family “Special FX” which is replaced by the “Drumkits”. You can remap the Sounds in the Sound Library so that the Program Changes and Bank Select numbers coincide with the sound mappings of other instruments.

How the Sound Library is organised

- The Sounds are organised in 16 Families, each consisting of 8 Program Changes (16x8 = 128).
- Each Program Change can belong to 16 “sound banks” (Bank Select 1...16).

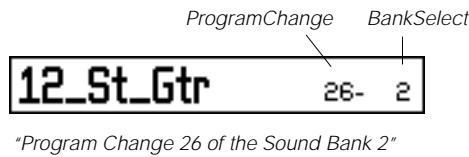

The Rom-Sound map listed in Family groups appears in the Appendix.

The Sound Library display

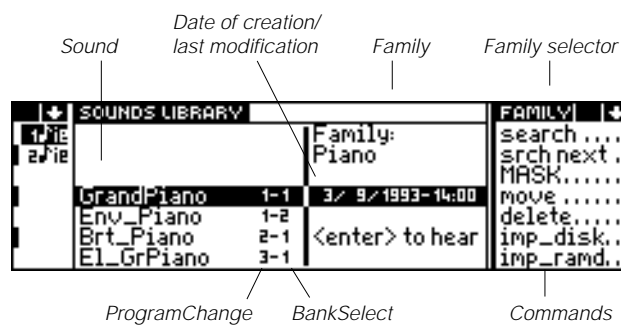

Selecting Families and Sounds

1. Select the Family with the MULTIFUNCTION BUTTONS.
2. Select the Sound by rotating the DIAL, or with the +1/> and -1/< buttons.
3. Press ENTER to assign the Sound selected to the currently selected track.

Step 1 can be skipped, but the search time will be longer.

Selecting Sounds by entering the Program Change and Bank Select number

1. Enter (a) the Program Change number, (b) the dash, (c) the Bank Select number.
2. Confirm your entries by pressing ENTER.
3. Press ENTER again to assign the Sound selected to the currently selected track.

Selecting Sounds with the search function

The “Search” function allows you to search for a Sound by specifying some of the characters in the name.

1. Select “Search”. The following edit zone appears where you can enter the characters:

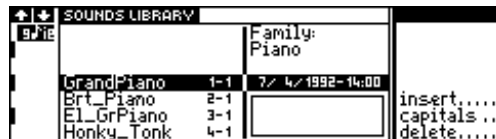

2. Specify the first two or three letters of the Sound’s name and press ENTER.
3. The cursor highlights a Sound. If it is not the sound you require, select “Search Next” to repeat the search task. Continue pressing “Search Next” until the cursor highlights the Sound you require.
4. Press ENTER to assign the Sound to the currently selected track.

Save the Performance to memorise the Sounds assigned to the tracks.

Commands/options

Search A Sound searching procedure by specifying some of the first characters of a Sound’s name. (S. previous paragraph).

Search Next Repeats the search operation.

Mask An option which allows specific types of Sound to be displayed by masking others, to simplify the Sound viewing possibilities in the Sound Library.

1. Select “Mask”. A selection window opens showing three types of Sounds:

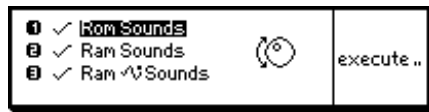

Rom Sounds The Sounds of the standard Sound Library; these can not be cancelled.

Ram Sounds The Sounds created by the user or loaded from disk (with the “Load” command or the IMP.DISK or IMP.RAMD commands of the Sound Library); these are based on the Rom Waveforms.

Ram Sounds The Sounds created by the user or loaded from disk (with the “Load” command or the IMP.DISK or IMP.RAMD commands of the Sound Library); these are based on Waveforms created with Sample Translator.

2. Select the type of Sounds to visualise (with the sign √) and those to mask (without the sign). Press ENTER to show or remove the sign √.

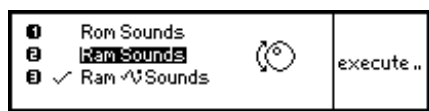

3. Select "Execute" with FUNCTION KEY D. The Sound Library display shows only the Sound type selected . For example.

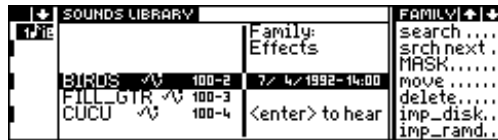

4. To return to the normal viewing mode (all Sounds) or to view other Sound types, repeat steps (1), (2) and (3).

Move

Procedure to moves a Sound to a different location. The move reassigns a different Program Change and Bank Select number to the Sound.

1. Select Sound to move.
2. Select the command "Move". The current Sound Library in memory is displayed, showing the empty locations as a string of dashes (-- -- -- --):

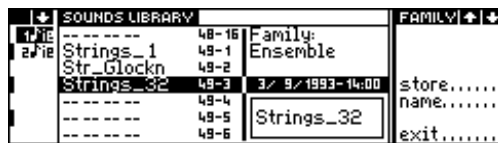

3. If necessary, you can change the name of the Sound (only Ram-Sound) with the "Name" command.
4. Select the destination location for the Sound. For example.

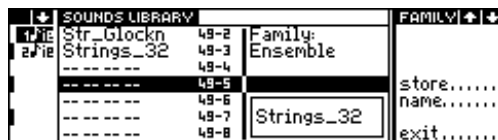

5. Select "Store" to execute the move operation.

Problems you may encounter (with relative displayed warning):

The Move affects the Sound Patch. The Sound Patch (and Drumkits) consists of Sounds in different locations. If you move a Sound that is used by a Sound Patch, the Sound Patch will be altered. In such a case you must reprogramme the Sound Patch accordingly.

If you attempt to move to an occupied location. Select an empty location marked with dashes (-- -- -- --).



Delete

Cancellation command of a Ram-Sound from the Sound Library. There are a number of rules to bear in mind when cancelling a Sound:

- Rom-Sounds can not be cancelled;
- you can not cancel a Sound currently in edit;
- if you cancel a Sound utilised by a Sound Patch, the Sound Patch will be damaged.

1. Select the Sound to cancel.
2. Activate the "Delete" command.

Imp.disk

Use this command to import data from floppy disks. Loads a Ram-Sound from the Sound Library contained in the floppy disk. The Sound becomes part of the Sound Library in the memory.

1. Insert the floppy disk containing the Ram-Sound to import in the drive.
2. Select "Imp.disk". The directory of the Ram-Sounds on the floppy disk is displayed:

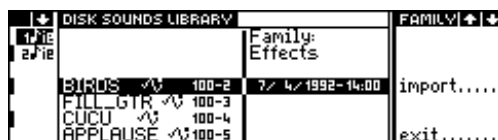

3. Select the Sound and select the "Import" command. The internal Sound Library is displayed showing the empty locations (-- -- -- --). Select an empty location in which to load the Sound:

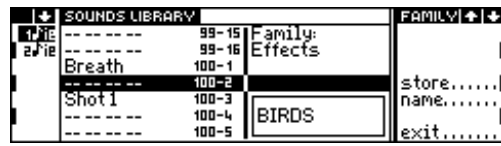



4. If necessary you can change the name of the imported Sound with the "Name" command.
5. You can also select a different location if necessary. Use the procedure you would use to select a Sound.
6. Select the "Store" command to load the Sound to the location selected.

Imp.ramd

Imports Sound from a Ram-disk. Loads a Sound from the Sound Library contained in the Ram-disk. The Sound becomes part of the Sound Library in the memory.

Follow the same procedure described for importing a Sound from floppy disk.

Types of Sounds and their identification symbols

Rom-Sound	Sound permanently resident in the Rom. These are not marked by any identification symbol.
Ram-Sound	User-created Sounds, based on the Waveforms resident in Rom. These are marked with a small dot after the name (■).
Ram  Sound	User-created Sounds based on Waveforms created with Sample Translator or contained in the Ram  Sound loaded from commercial floppy disks.
Sound Patch and Drumkit	Combinations of Sounds of the types described above. These are identified by the symbol " " (or by the symbol " ■" if they are user-created).

13 EFFECTS LIBRARIES

The Effects Libraries are two archives for the Effects (one for each of the two *Digital Signal Processors*, DSP). Library 1 contains the *Reverbs* and Library 2 contains the *Modulations*.

Library 1 Reverb.

Library 2 Delay, Chorus, Flanger, Phaser, Rotary, etc.

The Effects Libraries can be saved and loaded (always coupled) as an Effects Libraries–Setup. The standard Effects Libraries have 24 Effects each. Customised Effects Libraries can hold up to 64 Effects each.

The Effects can be edited by means of the EDIT EFFECT tasks, accessed from the Effects Libraries displays.

The Effects are recalled by the Performances (EDIT PERFORMANCE/CONTROL) and activated or deactivated for each track (EDIT PERFORMANCE/TRACKS).

Only the audio left and right outputs emit “wet” sounds. The Sounds emitted from the other audio outputs is “dry”. The EFF.BYPASS button deactivates the DSPs (led on).

How the Effects Libraries are organised

There are two pages, each containing a Library. Both pages have identical layouts

The Library name			Command column
EFFECT 1 LIBRARY			PAGE: 1
1xIE			edit
2xIE			
3xIE			
4xIE	Hall_1	0 1/1/92 - 8:00	move
5xIE	Hall_2	1	delete.....
6xIE	Hall_3	2	
7xIE	St_Hall_1	3	
		<enter> to hear	
EFFECT 2 LIBRARY			PAGE: 2
1xIE			edit
2xIE			
3xIE			
4xIE	Delay1_1	0 1/1/92 - 8:00	move
5xIE	Delay1_2	1	delete.....
6xIE	Delay2_1	2	
7xIE	Delay2_2	3	
		<enter> to hear	
	List of Effects	Date of the last modification	

Selecting the Effects

1. Access the Effects Libraries and select the page containing the Effect you wish to select.
2. Select the Effect by rotating the DIAL or by specifying its corresponding number on the NUMERIC KEYPAD.
3. Press ENTER to assign the Effect to the current Performance.

Save the Performance to memorise the assigned Effect.

Command/options

Edit Gains access to the EFFECT EDIT environment. The Effect with which you enter edit is the one highlighted by the cursor.

Move Procedure to move the Effect to a different location within its own Library.

1. Select the Effect to move and press "Move":

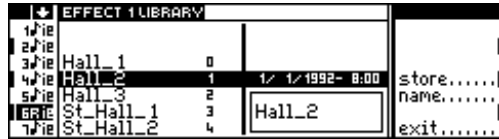

2. If necessary you can change the name of the Effect with the "Name" command.
3. Select an empty location, shown by the string of dashes (-- -- -- --).
4. Confirm the move by selecting "Store" command.

Delete Cancels the Effect highlighted by the cursor.

Note: The Effects Libraries cannot be completely empty. At least one Effect must reside in each Library.

Library 1 (standard)

0 Hall_1	6 Concert_1	12 SmallRoom 1	18 Early2_1
1 Hall_2	7 Concert_2	13 Med_Room 1	19 Early3_1
2 Hall_3	8 Church_1	14 LargeRoom 1	20 Stereo1_1
3 St_Hall_1	9 Vocal_1	15 LargeRoom 2	21 Stereo2_1
4 St_Hall_2	10 Plate_1	16 LargeRoom 3	22 Stereo3_1
5 St_Hall_3	11 Plate_2	17 Early1_1	23 Stereo4_1

Library 2 (standard)

0 Delay1_1	6 Panecho_3	12 Flanger1_1	18 Rotary1_1
1 Delay1_2	7 Dubbing_1	13 Flanger2_1	19 Rotary2_1
2 Delay2_1	8 Chorus1_1	14 Phaser1_1	20 Fladel_1
3 Delay2_2	9 Chorus1_2	15 Phaser2_1	21 Panmix_1
4 Panecho_1	10 Chorus2_1	16 Phaser3_1	22 Panmix_2
5 Panecho_2	11 Chorus2_2	17 Ensemble_1	23 Panmix_3

14 EDIT EFFECT

How to access the EFFECT EDIT

1. Select the Effect to modify in the effects libraries.
2. Press "Edit".

How to escape from the EFFECT EDIT

Select "Save" (saves your edits) or "Abort" (cancels your edits).

How the EDIT EFFECT environment is organised

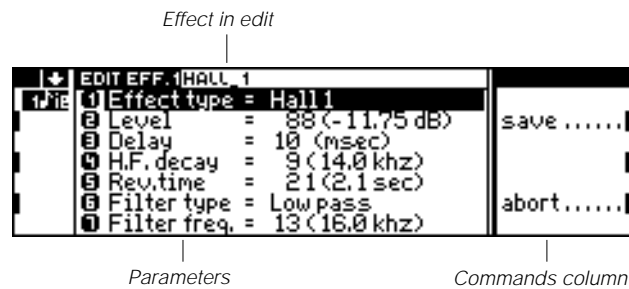

Parameters

The parameters change according to the type of effect being edited ("Effect Type").

Save

Saves the modifications made to the Effect.

1. Select "Save". The list of Effects is shown, with the original Effect selected:

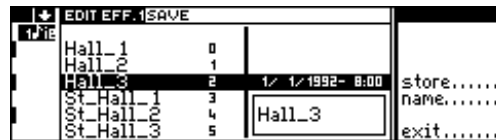

2. You can overwrite the original Effect or select an empty location, shown by the string of dashes (-- -- -- --).
3. Press "Store" to confirm the save operation.

Abort

Cancels the modifications and escapes from edit mode.

How to Programme the Effects of Library 1

Library 1 contains Reverbs with or without programmable *early-reflections*.

Programmable early-reflections permit the best determination of the position of the sound source with respect to the wall, specifying the quantity of the initial reflections (*early reflections*) before the reverb halo.

Reverbs without programmable early-reflections

Effect type	Effect type – simulates a “room”. Value range: Hall1, Hall2*, Concert Hall*, Church, Vocal, Plate, Small Room, Medium Room, Large Room*. *The reverbs identified by the asterisk are pseudo-stereophonic. They are effective only on the Stereo Left+Right outputs, or Head Phones.
Level	General level of the effect. Value range: 0 (-63.50 dB) ... 127 (0.0 dB).
Delay	Reverb delay. Determines the position of the sound source with respect to the “wall”. A longer delay corresponds to a greater distance from the “wall”. Value range: 0 ... 99 ms.
H.F. Decay	“High Frequency Decay”, decay of the high frequencies, or “attenuation”. Determines the reflection capacity of the walls. Walls with a low reflecting capacity have a greater decay velocity (major attenuation). This parameter is a dynamic filter. Low values correspond to greater attenuation. Value range: 0 [Bypass], 1 [1 khz] ... 10 [16 khz].
Reverb time	Duration of the Reverb. Determines the size of the “room”. The longer the reverb time the greater the dimensions of the “room”. Value range: 1 [0.1 sec] ... 100 [10 sec].
Filter type	Type of equalisation (High Pass or Low Pass). This is associated to the next parameter.
Filter frequency	Equalisation frequency (associated to the previous parameter). Value range: 0 [Bypass], 1 [0.1 khz] ... 13 [16 khz].

Reverbs with programmable early-reflections

Effects type	Type of effect, simulates a “room”. Value range: Early1, Early2, Early3*, Stereo1*, Stereo2*, Stereo3*, Stereo4*. *The reverbs identified by an asterisk are pseudo-stereophonic. They affect only the Stereo Left+Right outputs or Head Phones.
Level	General level of the effect. Value range: 0 (-63.50 dB) ... 127 (0.0 dB).
Room size	Size of the “room”. Value range: 0 ... 64.

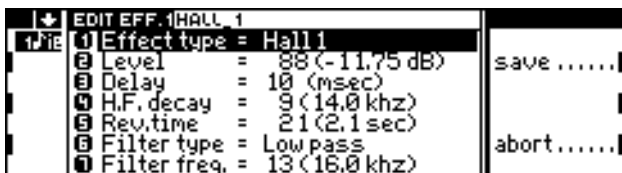

Reverb without programmable early-reflections

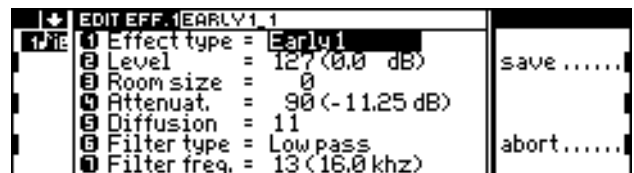

Reverb with programmable early-reflections

Attenuation	Reverb attenuation. Value range: 0 [-63.50 dB] ... 127 [0.0 dB].
Diffusion	Diffusion. Inserts a halo in the final part of the reverb. Value range: 0 ... 60.
Filter type	Type of equalisation (High Pass or Low Pass). This is associated to the next parameter.
Filter frequency	Equalisation frequency (associated to the previous parameter). Value range: 0 [Bypass], 1 [0.1 khz] ... 13 [16 khz].

How to Programme the Effects of Library 2

Library 2 contains the modulations (different types of Delay, Chorus, Flanger, Phaser, Rotary).

Delay, Panecho, Dubbing

Effect Type	Type of Delay/Panecho/Dubbing. Value range: Delay1, Delay2, PanEcho, Dubbing.
Level	Level of the effect. Value range: 0 [-63.50 dB] ... 127 [0.0 dB].
Feedback gain	Number of repetitions. With a "Delay" time of 510 ms and this parameter set to 99% the total duration of the effect is 11 seconds. Value range: 0 [4%] ... 14 [99%].
Delay	Determines the time lapse between repetitions. Value range: 0 ... 510 ms.
Filter	Dynamic equalisation. The high frequencies are gradually attenuated with each repetition. High values correspond to slower timbric changes. Value range: 0 [Bypass], 1 [0.1 khz] ... 12 [16 khz].

Chorus

Effect type	Type of Chorus. "Chorus2" is pseudo-stereophonic and affects only the stereophonic audio Left+Right outputs. Value range: Chorus1, Chorus2.
Level	Level of the effect. Value range: 0 [-63.50 dB] ... 127 [0.0 dB].

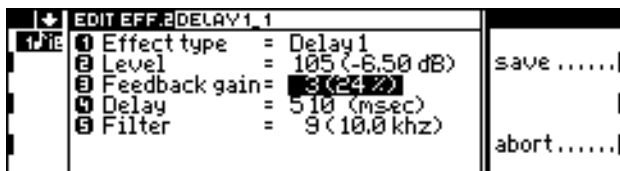

Delay, Panecho, Dubbing

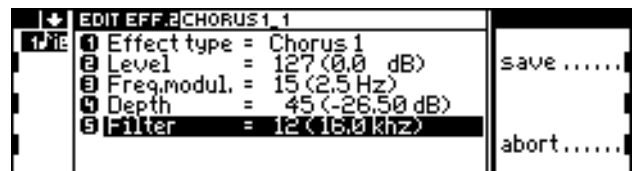

Chorus

Frequency modulation	Modulation speed of Chorus. Value range: 0 [0.3 khz] ... 28 [6.0 khz].
Depth	Modulation depth. Value range: 0 [-63.50 dB] ... 127 [0.0 dB].
Filter	Static equalisation. Modifies the high frequencies, which modify the timbric quality of Chorus. Value range: 0 [Bypass], 1 [0.1 khz] ... 12 [16 khz].

Flanger

Effect type	Type of Flanger. "Flanger2" is pseudo-stereophonic and affects only the stereophonic audio Left+Right outputs. Value range: Flanger1, Flanger2.
Level	Flanger level. Value range: 0 [-63.50 dB] ... 127 [0.0 dB].
Feedback	Automodulation of the Flanger. Enriches the harmonic content of the effect. Value range: 0 [0%] ... 17 [96%].
Depth	Modulation depth. Value range: 0 [-63.50 dB] ... 127 [0.0 dB].
Frequency modulation	Modulation speed of the Flanger. Value range: 0 [0.3 khz] ... 28 [6.0 khz].
Initial delay	Determines the initial delay before the Flanger begins to affect the sound. Value range: 0 ... 30 ms.

Phaser, Ensemble

Effect type	Type of Phaser/Ensemble. The effects identified with an asterisk (*) are pseudo-stereophonic, and affect only the Stereo Left-Right outputs. Value range: Phaser1, Phaser2*, Phaser3*, Ensemble*.
Level	Level of the effect. Value range: 0 [-63.50 dB] ... 127 [0.0 dB].
Feedback	Automodulation of the Phaser/Ensemble. Enriches the harmonic content of the effect. Value range: 0 [0%] ... 17 [96%].
Depth	Modulation depth. Value range: 0 [-63.50 dB] ... 127 [0.0 dB].
Frequency modulation	Modulation speed of Phaser/Ensemble. Value range: 0 [0.3 khz] ... 28 [6.0 khz].

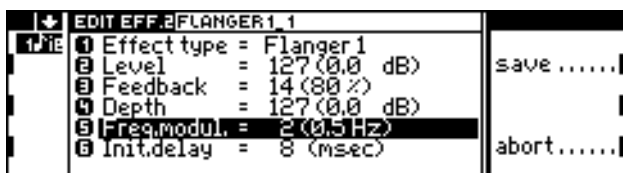

Flanger

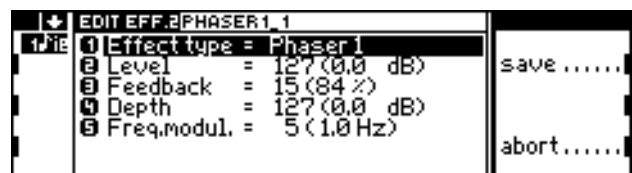

Phaser, Ensemble

Rotary

Effect type	Type of Rotary. Rotary is always pseudo-stereophonic and affects only the Stereo Left+Right outputs. Value range: Rotary1, Rotary2.
Level	Level of the effect. Value range: 0 [-63.50 dB] ... 127 [0.0 dB].
Feedback	Automodulation of the Rotary. Enriches the harmonic contents of the effect. Value range: 0 [0%] ... 17 [96%].
Speed	Determines the time required to pass from slow to fast or vice versa (check it by pressing FUNCTION SELECT KEY D). Value range: 0 [0.6 sec] ... 30 [9.6 sec].
Filter	Static equalisation. Attenuates the high frequencies, modifying the timbric quality of the effect. Value range: 0 [Bypass], 1 [0.1 khz] ... 12 [16 khz].
FUNCTION SELECT KEY D	Changes the initial direction of <i>slow-fast</i> vector. This parameter is useful during the edit phase; during its execution the vector is established for each Performance in EDIT PERFORMANCE/CONTROLS, page 2.

Fladel, Panmix

Effect type	Type of Fladel/Panmix. These effects are combinations of Flanger+Delay. Panmix is pseudo-stereophonic and affects only the Stereophonic Left+Right outputs. Value range: Fladel, Panmix.
Level	Level of the effect. Value range: 0 [-63.50 dB] ... 127 [0.0 dB].
Delay	The time that elapses between one repetition and the next. Value range: 0 ... 510.
Depth	Modulation depth of Flanger. Value range: 0 [-63.00 dB] ... 127 [0.0 dB].
Frequency modulation	Modulation speed of the Flanger. Value range: 0 [0.3 khz] ... 28 [6.0 khz].

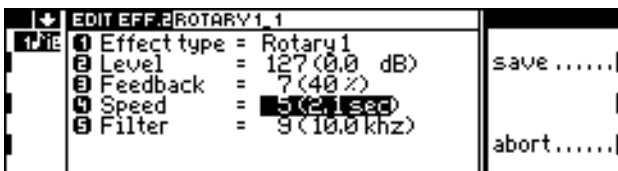

Rotary

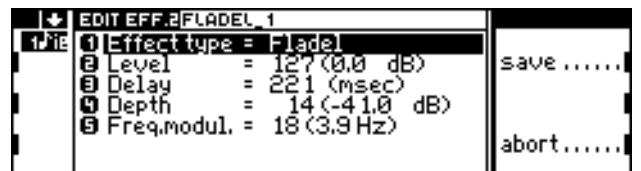

Fladel, Panmix

Notes and suggestions

Reverb Reverberation consists of a series of “waves”, called reflections, which comprise *early-reflections* and *tail reflections*. In the diagram, the early reflections are shown by the letters *a* and *b* while the tail reflections are between *c* and *d*:

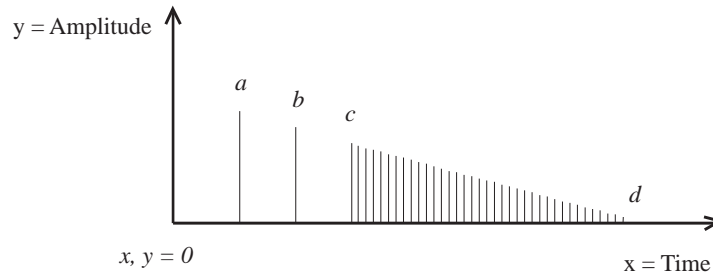

The DSP1 of the S Series can operate in two different ways:

- by keeping the distance that separates the early reflections constant, from point $x=0$ to point *c* (reverbs with non- programmable ER);
- by varying the distances that separate the *early reflections* (reverbs with programmable ER).

In the reverberation with programmable ER, the distance between $x=0$ and *a* is determined by the “Room Size” parameter. The distance between points *c* and *d* is determined by the “Diffusion” parameter. The harmonic quality of the reflections is obtained by combining the “Attenuation” parameter with the equalisation filter (“Filter type”, “Filter freq.”).

In reverberation with non-programmable ER, while the distance between points *a* and *c* is fixed, it is possible to edit the distances between $x=0$ and *a* with the “Delay” parameters, between *c* and *d* with the “Rev. time” parameter, and the harmonic quality of the reflections with “H.F.Decay”, “Filter type” and “Filter freq.”.

Types of reverbs In all effect processors (DSP), reverberation has standard names which indicate the type of “room” simulated (Hall, Room, Concert...). The following is a description of the characteristics of the S Series reverbs:

Hall1, Hall2, Concert	Concert hall.
Small Room, Medium Room, Large Room	Recording rooms of progressively larger dimension, respectively.
Vocal	Vocal recording rooms with extremely attenuated reflections.
Church	Cathedral with a high number of reflections.
Plate	Imitation of a plate reverberation consisting of an oscillating metal plate that was very popular in the past.

Types of modulation DSP2 can produce standard and very different special effects. Here is a description of the different modulations that can be obtained with the “non standard” modulations shown in italics:

Delay	Repetition of the sound, with decreasing intensity and gradual diminishing of the high frequencies.
<i>Panecho</i>	Delay with alternating repetitions between the two stereo channels.
<i>Dubbing</i>	Delay with repetitions on only one stereo channel.
Chorus	Duplication of the sound and phasing between the two components. Produces a multiplication of the sound sources, as occurs in an orchestra section, creating a softer sound.

Flanger	Similar to Chorus, dynamically enriches and reduces the harmonic content of the sound.
Phaser	Similar to Flanger, but with a faster modulation.
<i>Ensemble</i>	Similar to Phaser, accentuates the sensation of multiplication of the sound sources.
Rotary	Simulates the rotating speakers featured by many electric organs. The rotation speed varies dynamically from slow to fast.
<i>Fladel</i>	Combination of Flanger+Delay.
<i>Panmix</i>	Similar to the previous, but pseudo-stereophonic and with double speed.

15 CLIPBOARD

In EDIT PERFORMANCE/CONTROLS, EDIT PERFORMANCE/TRACKS, EDIT SOUND and EDIT EFFECT you can “copy” a page of parameter settings and place the copy in the Clipboard.

The Clipboard has six locations. It can be saved or loaded as a Clipboard-Setup.

The Clipboard is particularly useful for the creation of four-pole Filters in EDIT SOUND (s.). To create a filter of this kind you must copy the pages of Filter 1 (programming, envelope) to the corresponding pages of Filter 2.

Layout of the “Clipboard” page

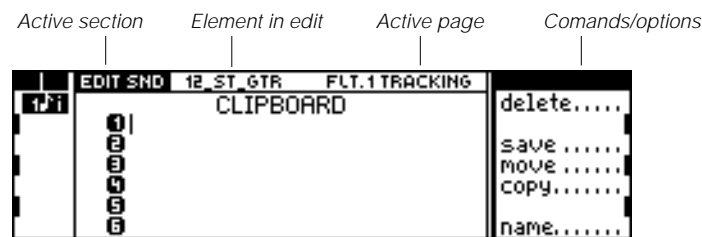

How to copy an edit page

1. Go to the edit page to copy.
2. Press the CLIPBOARD button. to activate the Clipboard display.
3. Select one of the six Clipboard locations. Press “Save” to memorise the current edit page in the Clipboard.
4. The page is memorised as “clipXX” (where XX is a number from 01 to 06). You can change the number with the command “Name”.
5. Return to the EDIT by pressing the button relating to the edit section or press EXIT to escape.

How to copy a clip to an edit page

1. Go to the edit page to which you want to copy the clip.
2. Press CLIPBOARD. The Clipboard page is displayed.
3. Select the clip to copy.
4. To copy the clip to the current edit page, press “Move” (the clip is removed from the Clipboard) or “Copy” (the clip remains in the Clipboard).

The Clipboard closes automatically after selecting “Move” or “Copy”.

How to cancel a clip from the Clipboard

1. Select the clip to cancel.
2. Press “Delete”.

16 UTILITY

The UTILITY section includes functions to rename, erase and copy Bank/Songs and Performances. It also contains the function to cancel the Clipboard–Setup from the internal memory.

“Juke_box”

This command chains the Song stored in the memory without interruptions, starting from the currently selected Song.

Press STOP to stop the playback.

Note: << and >> interrupt the Juke_Box; the sequencer stops when the Song currently playing ends.

Important: If a Song incorporates a “Song Loop” (EDIT SONG, “Utility” editor which repeats some bars), the “Juke–box” function is, in practice, terminated by the execution of the repeating section of the Song.

Utility

Bank/Song name	Changes the name of the Bank/Song selected. 1. Select the Bank/Song. 2. Access UTILITY and select the “Bank/Song name” function:
----------------	--



3. Change the name and confirm.

Performance name	Changes the name of the Performance selected. 1. Select the Performance. 2. Enter Utility and select the “Performance name” function:
------------------	---

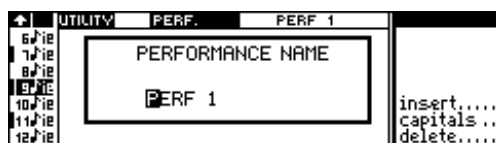

3. Change the name and confirm.

Delete Bank/Song	Cancels the Bank/Song selected.
Delete Performance	Cancels the Performance selected.
Delete Clipboard	Cancels the Clipboard–Setup.



Utility

Copy Bank/Song

Copies the Bank/Song selected to another Bank/Song (both the Performance Bank and the Song).

1. Select the Bank/Song to copy.
2. Select the "Copy Bank/Song" function:



3. Select a location in which to copy the Bank/Song. If the location selected is not empty, the previous Bank/Song is replaced by the Bank/Song you are copying.
4. Confirm your selection. You can change the name of the Bank/Song copy:



5. Confirm the operation. The Bank and Song are copied.

Suggestion: Make a copy of a Song that you are about to edit radically. This will allow you to compare the two versions of the Song and choose the best Song.

Copy Performance

Copies the Performance selected to the same Bank/Song or to another Bank/Song.

1. Select the Performance to copy.
2. Select the "Copy Performance" function. The directory of the Bank/Songs in the memory is displayed:



3. Select the Bank/Song to which you wish to copy the Performance. Confirm the Bank/Song. The list of Performances is displayed:



4. Select a location to which to copy the Performance. If the location is not empty, the previous Performance is replaced.
5. Confirm your selection. You can change the name of the Performance copy:



6. Confirm the operation. The Performance is copied.

17 PRELOAD

The Auto-Preload function is not operative when a Sound or an Effect is currently in edit.

Preload is a background loading facility which permits the loading of a Bank/Song while the sequencer is in playback mode (Song play). By choosing an appropriate option, the Song loaded can also take with it the associated Sound Library and Effects Libraries (with the “Auto” option active).

If the “Auto” option is deactivated, the Preload function is equivalent to a high-speed version of the “Load Single Bank/Song” operation (some of the steps that are performed in the normal loading mode are eliminated).

With the “Auto” option selected, the current Sound Library and the Effects Libraries in memory are replaced by those associated to the Song being loaded (if they differ to those already present). The current Bank/Songs present in memory are also cancelled (only the Preloaded Bank/Song remains).

For example, after powering up, play the Demo Song resident in memory. While the Song is playing, Preload the Song contained in Demo Disk 01, with the “Auto” option active. The default Sound Library and the Effects Libraries are replaced with the corresponding Setups contained in Demo Disk 01.

1. While a Song is playing, press the PRELOAD button. The disk Bank/Song directory is displayed:

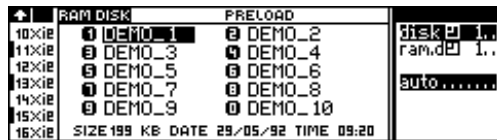

If no disk is inserted, an error message is shown:



If the RAM-disk is installed, the Bank/Song directory contained in the RAM-disk is displayed:



2. If necessary, select a different Group of Bank/Songs, by pressing repeatedly the function key corresponding to the selected disk (*S. Disk*).
3. Activate or deactivate the “Auto” option.
4. Select a Bank/Song to load and confirm.
5. If “Auto” is not selected, select a destination Bank/Song in memory (you can also select the Bank/Song of the Song currently in playback - in this case, the Song will stop playing):

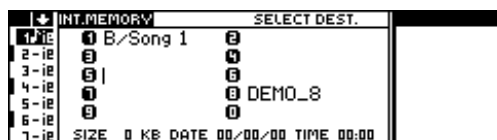

6. Confirm the Preload operation and, depending on the selected Preloading status, the following will occur:
- If the “Auto” option is not selected the Bank/Song being preloaded will be loaded to the selected destination. If the destination is already occupied, the old Bank/Song will be replaced by the one being loaded. If you choose to replace the Song in playback, it will stop playing.
 - If the “Auto” option is selected, the Bank/Song will be loaded to B/S location 1 or 2 (B/S 1 will be picked if the Song in playback belongs to the B/S from 2 - 10; otherwise B/S 2 if Song 1 is playing or if only one Song is present in memory).

The Sound Library and Effects Libraries setups are loaded but do not substitute the old Setups until the Song in playback stops playing. If the total dimensions of the Setups in memory and those to load exceed 2 Megabytes (the dimensions of the Sample-Ram), the samples present in memory (contained in the Ram  Sounds) must be replaced, and the instrument requests confirmation before proceeding:

```
Samples will be overwritten!  
<enter> to confirm  
<exit> to cancel
```

APPENDIX

 MIDI

- MIDI Implementation Chart
- MIDI Messages / MIDI Controllers
- MIDI System Exclusive Code Interface

 ROM-WAVEFORMS, SOUNDS, PERFORMANCES

 DRUMKITS & PERCUSSION SAMPLES

 TECHNICAL SPECIFICATIONS

***MIDI IMPLEMENTATION CHART,
MIDI CONTROLLERS,
SYSTEM EXCLUSIVE***

MIDI IMPLEMENTATION CHART

MIDI IMPLEMENTATION CHART		MODEL S2/S3/S2R		DATE: 25.10.1993 VERSION: 1.0
Function		Transmitted	Recognised	Remarks
Basic Channel	Default Changed			2 MIDI IN/OUT/THRU EXTRA COMMON CH.
Mode	Default Messages Altered	MULTI MODE X X	MULTI MODE X X	FOR MIDI: SINGLE MODE can be memorized
Note Number	True Voice	0 – 127 *****	0 – 127	TRUE VOICE: depends on selected sounds
Velocity	Note ON Note OFF	O O	O O	
After Touch	Key's Ch's	O O	O O	
Pitch Bend		O	O	
Control Change		MIDI COMMON CHANNEL: 7 MAIN VOLUME 4MASTER7 21 EFF.1 NUMBER 0 ~ 63 22 EFF.2 NUMBER 0 ~ 63 23 EFF.1 VOLUME 24 EFF.2 VOLUME 90 ROTARY SLOW/FAST OTHER CHANNELS: CONTROL 0 TO 31 CONTROL 64 TO 79		MIDI Common Channel also receives Aftertouch, Modulation (Cntrl.1) and Damper (Cntrl.64) messages and assigns them to all active tracks. Balance (Cntrl.8) only affects Dual Oscillator Sounds.
		0 EXTEND.PR.CH. BANK SELECT Dual Oscillator Sounds. 1 MODULATION 7 VOLUME 8 BALANCE 10 PANORAMA 12 ATTACK TIME 13 RELEASE TIME 14 FILT.1 CUT. FREQ. 15 FILT.2 CUT. FREQ. 20 FILT. 1+2 CUT. FREQ. 64 DAMPER PEDAL 66 SOSTENUTO 67 SOFT PEDAL		
Program Change	True Number	0 – 127 / 0 – 99* *****	0 – 127 / 0 – 99*	
System Exclusive		O	O	
System Common	:Song Pos :Song Sel :Tune	O X X	O X X	
System Real/Time	:Clock :Commands	O O	O O	
Aux Messages	:Local On/Off :All Notes Off :Active Sens :Reset	X O O X	X O O X	
Notes		* PERFORMANCE / SONG CHANGE ON COMMON CHANNEL		

MIDI MESSAGES / MIDI CONTROLLERS

The MIDI messages transmitted and received by the S Series (and by the more recent MIDI instruments) are:

NOTE: Note data, consisting of four values: note name, velocity on, velocity off, gate (note duration).

PITCH BEND: Lowering or highering of the pitch, sent by a dedicated controller (e.g. a Wheel).

MONO TOUCH (or Channel Pressure): Pressure applied to a key after playing the note (key on). Applying pressure to one note affects all the notes of the same Midi channel.

Poly Touch (or Poly Pressure): Pressure applied to a key after playing the note (key on). Applies to the note playing and does not affect other notes being played. It consists of two values: note on which the pressure is applied, the intensity of the pressure applied.

Program Change: Sound selecting data.

Control Change: Various messages which control single Sound parameters (volume, pan) or the overall setting of the instrument (All note off, Omni mode on, Reset).

A Control Change message activates a MIDI Controller, a series of software controls of the sound. The Control Change message consists of two numerical parts: (n1) the number which determines the activation of the Midi Controller, (n2) the value of the MIDI Controller:

Control Change, n1, n2

The following table lists all the Midi Controllers in numerical order. Next to the decimal number of the Controller is the name of the function that is controlled. Controllers 0 ... 31 are “continuous” controls, which affect a parameter for the duration that they are applied. Controllers 64 ... 127 are “switch action” controllers, which remain active until the Controller is applied again.

Controllers 32 ... 63 are the LSB (*Least Significant Byte*) part of the message transmitted by the Controllers 0 ... 31 (which are the part MSB (*Most significant Byte*)). The coupling between the MSB and LSB takes place without user intervention.

Some Midi Controllers, coded as “unused” in the Midi protocol standard, have been utilized by the S Series as specific controllers which permit the modification via Midi of some of the S Series Sound parameters (Attack, Release, Filters, Effects). The function implemented in the S Series is shown in square brackets [].

Messages shown in grey affect the S Series sound generation. Messages identified by an asterisk (*) travel on the Midi-Comon Out channel and not on the channel assigned to the track.

(00) Control 0 / BankSelect
(01) Modulation
(02) Breath

(03) Control 3
(04) Foot Controller
(05) Portamento Time

(06) Data Entry
(07) Main Volume
(08) Balance [Osc 1/2]
(09) Control 9
(10) Panorama
(11) Expression
(12) [Attack]
(13) [Release]
(14) [Filter 1 Cutoff]
(15) [Filter 2 Cutoff]
(16) Gen. purp. control. 1
(17) Gen. purp. control. 2
(18) Gen. purp. control. 3
(19) Gen. purp. control. 4
(20) [Filters 1+2 Cutoff]
(21) Effect 1 number*
(22) Effect 2 number*
(23) Effect 1 volume*
(24) Effect 2 volume*
(25 ... 31) Controls 25 ... 31
(32 ... 63) LSB Cntrl 0 ... 31
(64) Damper
(65) Portamento
(66) Sostenuato
(67) Soft Pedal
(68) Control 68
(69) Hold 2
(70 ... 79) Controls 70 ... 79
(80) Gen. purp. control. 5
(81) Gen. purp. control. 6
(82) Gen. purp. control. 7
(83) Gen. purp. control. 8
(84 ... 89) Controls 84 ... 89
(90) Rotary slow/fast*
(91) External Effect Depth
(92) Tremolo Depth
(93) Chorus Depth
(94) Celeste Depth / Detune
(95) Phaser Depth
(96) Data increment
(97) Data decrement
(98) Non-Reg.Par.Num.(LSB)
(99) Non-Reg.Par.Num.(MSB)
(100) Reg.Par.Num. (LSB)
(101) Reg.Par.Num. (MSB)
(102...120) Controls 102...120
(121) Reset control
(122) Local control
(123) All Note off
(124) Omni Mode off
(125) Omni on
(126) Mono Mode on
(127) Poly Mode on

MIDI SYSTEM EXCLUSIVE CODE INTERFACE

Introduction

MSECI (Midi System Exclusive Code Interface) is a tool which permits a full operational interface with other devices (Host computer, other GENERALMUSIC device, etc.).

The user can access many resources contained in GENERALMUSIC devices (files, edit structures, global structures).

MSECI permits the programmer to write software for many features, such as Machine Backup, Host Edit Interface, etc..

An expert programmer with a good knowledge of the uses of MSECI can write an excellent software for the complete control of GENERALMUSIC devices.

Communications are achieved using MMA standard similar protocol.

In this document, all software examples are written in C language and the *italic* characters are identifiers defined in include files.

General Overview

MSECI consists of three parts:

1) File Functions

Here you will find the commands for a low level internal file access.

The use of these commands are recommended for expert programmers, because their incorrect use can damage the internal file structure. However, File Functions aren't often useful.

2) Edit Functions

Here you will find the commands to access internal data structures which can be edited.

To write a software program which performs external editing functions, the programmer must be acquainted with the specific internal edit structures, which can differ from one GENERALMUSIC device to another.

3) Device Commands

In this part you will find commands for a general access to the internal system.

The use of these commands is a valid alternative for internal file access and their use is recommended.

This is an example of a general MSECI string:

```
F0  midisystemexclusiveidentifier
2F  GENERALMUSICexclusivecode
fc  f=functionnumber(0-7)  c=channel(0-F)
ss  ss=subfunction(0-6F,70-7Freserved)
rc  rc=requestchannel(0-F)
..
..  data
..
cc  cc=checksumifimplemented
F7  endmidisystemexclusive
```

MSECI also includes a series of HANDSHAKE commands.

A special conversion mode, from 8 bit to 7 bit MIDI data, is used for binary data transmission, in which 7 real bytes are converted to 8 MIDI bytes, known as an OCTECT (fig.1,ex.1,ex.2).

When the above conversion is performed in reverse, the receiving algorithm must be written with care, because the data packet is a finite number of octects and the number of received bytes can be more than the real bytes transmitted, therefore, the receiver must refer to the data header for the exact number of bytes.

The function and subfunction identifiers are defined in the include file "sys_id.h".

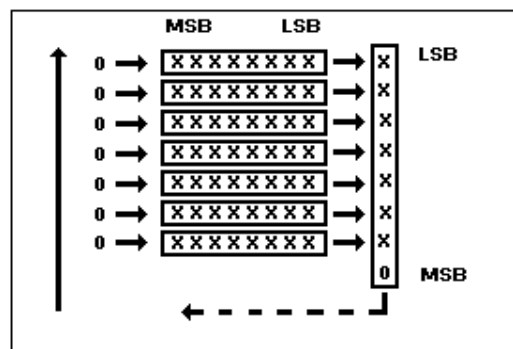

Fig. 1: 8 to 7 bit conversion

Example 1: 8 to 7 bit conversion

1245F7A353B03A—conv8_7 → 09227F5129581D1E
 (7 bytes) (8 bytes)

```
void conv8_7 ( dest, src)
unsigned char *dest, *src;
{
    int i;
    unsigned char accum = 0;

    for (i=0; i<7; i++)
    {
        accum |= ((*src & 0x1) << i);
        *dest++ = (*src++ >> 1);
    }
    *dest = accum;
}
```

Example 2: 7 to 8 bit conversion

```
void conv7_8 (dest, src)
char *dest, *src;
{
    int i;

    char bit8 = src [7];
    for (i = 7; i > 0; i--, bit8 >>= 1)
        *dest++ = (*src++ << 1) + (bit8 & 1);
}
```

Handshake Commands

F0 2F fc ss hh oc F7
 f = function number (0-7)
 c = channel(0-F)
 ss = subfunction (0-6F, 70-7F reserved)
 hh = 7F = ACK (ok or go on)
 7E = NACK (not ok, repeat last)
 7D = CANCEL (abort operation)
 7C = _WAIT (wait for response)
 oc = own channel(0-F)

FILE FUNCTIONS FILE_F**FILE DUMP HEADER F_DHDR**

F0 2F 0c 01 oc <file name> ff <info> <location> cc F7
 c = channel (0-F)
 oc = own channel (0-F)
 file name = 8 chars file name + 3 chars extension
 ff = flags
 info = 2 octets = 16 bytes of binary info time/date/length/
 instrument ID/file id
 location = 1 up 80 chars string NULL terminate
 cc = checksum (xor of all bytes from 2F)

After the receiver has received the header, the _WAIT command is sent back and the checksum test is then performed; if the checksum test fails, the receiver sends back a NACK command and the host must repeat the header transmission. If the test is 'ok', the receiver sends back an ACK command and the host can then send the next packet.

When the receiver has performed the <info> with conversion (conv7_8), the result is an 14 byte structure, as shown in ex. 3 below.

Example: 3 INFO structure

```
typedef struct
{
    short Time;
    short Date;
    long Length;
    char DeviceClass;
    char DeviceSubClass;
    char DeviceRelease;
    char FileType;
    char FileFormat;
    char FileRelease;
}INFO;
```

FILE DUMP DATA BLOCK *F_DPKT*

F0 2F 0c 02 oc oo <pkt> cc F7
 c = channel (0-F)
 oc = own channel (0-F)
 oo = number of octets
 pkt = binary data in octets
 cc = checksum (xor of all bytes from 2F)

After the receiver has received the datapacket, the _WAIT command is sent back and the checksum test is then performed; if the checksum test fails, the receiver sends back a NACK command and the host must repeat the same data. If the test is 'ok', the receiver converts (conv7_8 ex.2) then sends back an ACK command and the host can then send the next packet.

FILE DUMP REQUEST *F_DREQ*

F0 2F 0c 03 rc <file name> <location> cc F7
 c = channel (0-F)
 rc = request channel (0-F)
 file name = 8 chars file name + 3 chars extension
 location = 1 up 80 chars string NULL terminate
 cc = checksum (xor of all bytes from 2F)

After the receiver has received the F_DREQ command, the _WAIT command is sent back and the checksum test is then performed; if the checksum test fails, the receiver sends back a NACK command and the host must repeat the command. If the test is 'ok', the receiver tries to open the file. If an error occurs during this operation, an F_ERR command is sent back, otherwise an F_DHDR is sent back.

FILE DIRECTORY HEADER *DIR_HDR*

F0 2F 0c 00 oc <dir name> ff <info> <location> cc F7
 c = channel (0-F)
 oc = own channel (0-F)
 dir name = 8 chars file name + 3 chars extension
 ff = flags
 info = 2 octets = 16 bytes of binary info time/date/length/
 instrumentID/file id
 location = 1 up 80 chars string NULL terminate
 cc = checksum (xor of all bytes from 2F)

This command is used to send directory information.

FILE DIRECTORY REQUEST *DIR_DRQ*

F0 2F 0c 04 rc <dir name> <location> cc F7
 c = channel (0-F)
 rc = request channel (0-F)
 dir name = 8 chars file name + 3 chars extension
 location = 1 up 80 chars string NULL terminate
 cc = checksum (xor of all bytes from 2F)

FILE ERROR *F_ERR*

F0 2F 0c 7B oc ee cc F7
 c = channel (0-F)
 oc = own channel (0-F)
 ee = error number (0-7F) (ex. 4)

Example 4: FILE ERROR IDENTIFIERS

```
enum {
    No_error,
    Job_invalid, Job_in_use, Operation_invalid,
    Drive_invalid, Drive_no_write,
    Media_invalid, Media_corrupt, Media_protected,
    Media_full,
    Media_not_inserted, Media_not_equal,
    File_not_found, File_open, File_in_write, File_protected,
    File_exists,
    MFH_error
};
```

EDIT FUNCTIONS

EDIT_F

EDIT PARAMETER REQUEST *PAR_REQ*

F0 2F 2c 02 rc oo <hdr> cc F7
 c = channel (0-F)
 rc = request channel (0-F)
 oo = octets number = 1
 hdr = 1 octect of request header (ex. 5)
 cc = checksum (xor of all bytes from 2F)

Example 5: EDIT HEADER (see "edt_ifc.h")

```
typedef struct
{
    uchar family, group, index, type;
    uchar nr_bytes, user_nr;
} EDT_IFC_HEAD;
```

Below is an example of a request parameter of the slot "MOVE EVENTS" of the sequencer:

```
EDT_ICF_HEAD hdr;
hdr.family = F_song;      /* see "edt_ifc.h" */
hdr.group = G_move;      /* see "s2_sequ.h", or other
                           device's include file */
hdr.index = 0;           /* not used */
hdr.type = Group_data;   /* see "edt_ifc.h" */
hdr.nr_bytes = 0;        /* used only for response */
hdr.user_nr = 0x7F;      /* not used */
```

EDIT PARAMETER ANSWER *PAR_ASW*

F0 2F 2c 04 rc oo <data> cc F7
 c = channel (0-F)
 rc = request channel (0-F)
 oo = octets number
 data = 1st octect contains data header and the next contains data parameters (ex. 5)
 cc = checksum (xor of all bytes from 2F)

EDIT PARAMETER SEND+REQUEST *PAR_SND*

F0 2F 2c 03 rc oo <data> cc F7
 c = channel (0-F)
 rc = request channel (0-F)
 oo = octets number
 data = 1st octect contains data header and the next contains data parameters (ex. 5)
 cc = checksum (xor of all bytes from 2F)

When the device receives this command, after checking for data errors or data range, it sends back the correct data.

EDIT EXECUTE *EXECUTE*

F0 2F 2c 05 rc oo <hdr> cc F7
 c = channel (0-F)
 rc = request channel (0-F)
 oo = octets number = 1
 hdr = 1 octect of edit execute header (ex. 5)
 cc = checksum (xor of all bytes from 2F)

In many edit slots, the user must perform an execute command to complete the edit.

For example, when we need to modify a sequence with a MOVE operation, after we have edited the MOVE parameter we must perform an EXECUTE command.

EDIT UPDATE *_UPDATE*

F0 2F 2c 06 ff gg oc F7
 c = channel (0-F)
 ff = family
 gg = group
 oc = own channel. (0-F)

When the receiver receives an _UPDATE command, it must perform a PAR_REQ command to refresh the data.

DEVICE COMMAND *DEVICE_CMD*

STATUS REQUEST *STAT_REQUEST*

F0 2F 5c 00 oc F7
 c = channel (0-F)
 oc = own channel (0-F)

STATUS ANSWER *STAT_ANSWER*

F0 2F 5c 01 oc <data> cc F7
 c = channel oc = own channel.
 <data> = 3 octets filled with the STAT structure
 cc = checksum (xor of all byte from 2F)

Example 6: STAT (see “sys_id.h”)

```
typedef struct
{
    unsigned char iClass,iSubClass,iRelease;
    unsigned char dummy;
    long TotalMem,FreeMem,FreeSampleMem;
    short ReadyFor; /*bit0=Sound,bit1=Setup,bit2=Song/
    perf*/
    short ActBankPerf;
}STAT;
```

BANK PERFORMANCE CHANGE *BANK_PERF_CHG*

F0 2F 5c 02 oc bb pp F7
 c = channel (0-F)
 oc = own channel (0-F)
 bb = bank
 pp = performance.

PREPARE SOUND ACCESS *PREPARE_soundAccess*

F0 2F 5c 03 oc F7
 c = channel (0-F)
 oc = own channel.(0-F)

UNPREPARE SOUND ACCESS *UNPREPARE_soundAccess*

F0 2F 5c 04 oc F7
 c = channel (0-F)
 oc = own channel. (0-F)

PREPARE BANK ACCESS *PREPARE_bankAccess*

F0 2F 5c 05 bb oc F7
 c = channel (0-F)
 bb = bank
 oc = own channel. (0-F)

UNPREPARE BANK ACCESS *UNPREPARE_bankAccess*

F0 2F 5c 06 bb oc F7
 c = channel (0-F)
 bb = bank
 oc = own channel. (0-F)

PREPARE EFFECT ACCESS *PREPARE_effectAccess*

F0 2F 5c 07 oc F7
 c = channel (0-F)
 oc = own channel. (0-F)

UNPREPARE EFFECT ACCESS *UNPREPARE_effectAcces*

F0 2F 5c 08 oc F7
 c = channel (0-F)
 oc = own channel. (0-F)

PREPARE GENERAL ACCESS *PREPARE_generalAccess*

F0 2F 5c 09 oc F7
 c = channel (0-F)
 oc = own channel. (0-F)

UNPREPARE GENERAL ACCESS UNPREPARE_generalAccess

F0 2F 5c 0A oc F7
 c = channel (0-F)
 oc = own channel. (0-F)

PREPARE STYLE ACCESS PREPARE_StyleAccess

F0 2F 5c 18 bb oc F7
 c = channel (0-F)
 bb = bank
 oc = own channel. (0-F)

UNPREPARE STYLE ACCESS UNPREPARE_StyleAccess

F0 2F 5c 19 bb oc F7
 c = channel (0-F)
 bb = bank
 oc = own channel. (0-F)

DATA DUMP HEADER DATA_HEADER

F0 2F 5c 0C oc dd bb pp <file name1> f1 <inf1> <file name2>
 ck F7
 c = channel (0-F)
 oc = own channel (0-F)
 dd = enum {Sound, Sample, Soundmap, Effect1, Effect2, General, Song, Perf}
 bb = ASCII Bank number (used only on Song & Perf)
 pp = ASCII Perf number (used only on Perf)
 <file name1> = 11 byte filename
 f1 = file flags
 <inf1> = 2 octects (time/date/length/instr.ID/file ID)
 <file name2> = 11 byte filename (used only on Perf for song name)
 ck = checksum (xor of all byte from 2F)

DATA DUMP DATA_DUMP

F0 2F 5c 0D oc oo <pkt> cc F7
 c = channel (0-F)
 oc = own channel (0-F)
 oo = number of octects
 pkt = binary data in octects
 cc = checksum (xor of all bytes from 2F)

After the receiver has received the data packet, the _WAIT command is sent back and the checksum test is then performed; if the checksum test fails, the receiver sends back a NACK command and the host must repeat the same data. If the test is 'ok', the receiver converts (conv7_8 ex.2) then sends back an ACK command and the host can then send the next packet.

DELETE DELETE

F0 2F 5c 0E oc dd bb pp <file name> ck F7
 c = channel (0-F)
 oc = own channel (0-F)
 dd = enum {Sound, Sample, Soundmap, Effect1, Effect2, General, Song, Perf, Global, StylePerf, Realtime Perf, Riff} (see "sys_id.h")
 bb = ASCII Bank number (used only on Song & Perf)
 pp = ASCII Perf number (used only on Perf)
 <file name > = 11 byte filename
 ck = checksum (xor of all byte from 2F)

DIRECTORY REQUEST DIR_REQUEST

F0 2F 5c 0F oc dd bb pp <file name1> ck F7
 c = channel (0-F)
 oc = own channel (0-F)
 dd = enum {Sound, Sample, Soundmap, Effect1, Effect2, General, Song, Perf, Global, StylePerf, RealtimePerf, Riff}
 bb = ASCII Bank number (used only on Song & Perf)
 pp = ASCII Perf number (used only on Perf)
 <file name > = 11 byte filename (wildcard)
 ck = checksum (xor of all byte from 2F)

DIRECTORY ANSWER *DIR_ANSWER*

F0 2F 5c 10 oc dd bb pp <file name1> f1 <inf1> <file name2>
ck F7
c = channel (0-F)
oc = own channel (0-F)
dd = enum {Sound, Sample, Soundmap, Effect1, Effect2, General, Song, Perf, Global, StylePerf, RealtimePerf, Riff}
bb = ASCII Bank number (used only on Song & Perf)
pp = ASCII Perf number (used only on Perf)
<file name1> = 11 byte filename
f1 = file flags
<inf1> = 2 octects (time/date/length/instr.ID/file ID)
<file name2> = 11 byte filename (used only on Perf for song name)
ck = checksum (xor of all byte from 2F)

Must repeat for all the file and directory. At the end a cancel is send for terminate dump.

DATA REQUEST *DATA_REQUEST*

F0 2F 5c 0B oc dd bb pp <file name> ck F7
c = channel (0-F)
oc = own channel (0-F)
dd = enum {Sound, Sample, Soundmap, Effect1, Effect2, General, Song, Perf}
bb = ASCII Bank number (used only on Song & Perf)
pp = ASCII Perf number (used only on Perf)
<file name > = 11 byte filename (used only on Sound & Sample)
ck = checksum (xor of all byte from 2F)

MESSAGE CAPTURE ON *MESSAGECAPTUREON*

F0 2F 5c 11 oc F7
c = channel (0-F)
oc = own channel. (0-F)

MESSAGE CAPTURE OFF *MESSAGECAPTUREOFF*

F0 2F 5c 12 oc F7
c = channel (0-F)
oc = own channel. (0-F)

MESSAGE SEND *MESSAGESEND*

F0 2F 5c 13 <message> oc ck F7
c = channel (0-F)
<message> = message string (ascii) (see MIOS doc.)
oc = own channel. (0-F)
ck = checksum (xor of all byte from 2F)

MESSAGE ANSWER *MESSAGEANSWER*

F0 2F 5c 11 oc rr F7
c = channel (0-F)
oc = own channel. (0-F)
rr = return code (1-5)

ENABLE EDIT UPDATE *ENABLEEDITUPDATE*

F0 2F 5c 15 oc F7
c = channel (0-F)
oc = own channel. (0-F)

DISABLE EDIT UPDATE *DISABLEEDITUPDATE*

F0 2F 5c 16 oc F7
c = channel (0-F)
oc = own channel. (0-F)

DEVICE ERROR *D_ERR*

F0 2F 5c 7B oc ee cc F7
c = channel (0-F)
oc = own channel (0-F)
ee = error number (0-7F) (ex. 7)

Example 7: DEVICE ERROR IDENTIFIERS

```
enum {
    ActiveBankAccess=MFH_error+1,
    IncompatibleObject,BadObjOperation, StyleRecAccess
};
```

WRITE KEY *PUT_KEY*

F0 2F 5c 17 mm ll F7
c = channel (0-F)
mm = Msb key
ll = Lsb key

WAVEFORMS, SOUNDS AND PERFORMANCES

LIST OF THE WAVEFORMS RESIDENT IN ROM (ROM-WAVEFORMS)

1)	Piano	71)	Muted_Trp2	141)	Vox_Tip
2)	Honky Tonk	72)	FrenchHorn	142)	Car_Horn
3)	El.Piano 1	73)	Brass	143)	Door
4)	El.Piano 2	74)	Brass_Rips	144)	Rapsy_Ride
5)	El.Piano 3	75)	Brass_Trp	145)	Baby_Vox
6)	El.Piano 4	76)	Anlg_Brass	146)	Dolly_Vox
7)	El.Piano 5	77)	Dual_Brass	147)	Kitchen
8)	El.Piano 6	78)	Brass_2	148)	Logdrum
9)	El.Piano 7	79)	Sopran_Sax	149)	Noise_Perc
10)	Harpsich_1	80)	Soft_Sax	150)	Agogo
11)	Harpsich_2	81)	Tenor_Sax	151)	Conga
12)	Clavinet	82)	Oboe	152)	Conga_acc
13)	Vibes_1	83)	Eng_Horn	153)	Conga_slap
14)	Vibes_2	84)	Bassoon	154)	Cowbell
15)	Glockenspl	85)	Clarinet	155)	Bongos
16)	Marimba	86)	Flute	156)	Darbuka_hi
17)	Bell	87)	Hardflute_1	157)	Darbuka_lo
18)	Dulcimer	88)	Hardflute_2	158)	Guiro
19)	Barchimes	89)	Panflute	159)	Quica_hi
20)	Theatre Org	90)	Bottle	160)	Quica_lo
21)	Organ 1	91)	Whistle	161)	Vibraslap
22)	Organ 2	92)	Sinus_Wv	162)	Castanets
23)	Organ 3	93)	Trian_Wv	163)	Tambourine
24)	Organ 4	94)	Square_Wv	164)	Timbales
25)	Organ 5	95)	Pulse_05Wv	165)	Cabasa
26)	Organ 6	96)	Pulse_10Wv	166)	Bdrum_elet
27)	Jazz_Org	97)	Pulse_15Wv	167)	Bdrum_gate
28)	Rock_Org	98)	Pulse_20Wv	168)	Bdrum_hard
29)	Syn_Organ	99)	Pulse_25Wv	169)	Bdrum_jazz
30)	Wired_Org	100)	Pulse_30Wv	170)	Bass_drum1
31)	Digit_1_Wv	101)	Pulse_35Wv	171)	Bass_drum2
32)	Digit_2_Wv	102)	Pulse_40Wv	172)	Woodblock
33)	Pipe_Org_1	103)	Pulse_45Wv	173)	Claves
34)	Pipe_Org_2	104)	Saw_Wv	174)	FingerSnap
35)	Pipe_Org_3	105)	Sup_Saw_Wv	175)	Side_Stick
36)	Accordion	106)	Frog_Wv	176)	Snare_dr_1
37)	Harmonica	107)	Spectrum_1	177)	Snare_dr_2
38)	Nyl_st_Gtr	108)	Spectrum_2	178)	Snare_rim1
39)	Vocal_Gtr	109)	SpectBells	179)	Snare_rim2
40)	Stl_st_Gtr	110)	Machinery	180)	Concert_sd
41)	12st_Gtr	111)	CityBreath	181)	Rimshot
42)	Jazz_Gtr_1	112)	Spatial	182)	Snare_EI_1
43)	Jazz_Gtr_2	113)	Fantasy_1	183)	Snare EI_2
44)	Oct_Jz_Gtr	114)	Fantasy_2	184)	Sd_brush_1
45)	Electr_Gtr	115)	Fantasy_3	185)	Sd_brush_2
46)	Muted_Gtr1	116)	Fantasy_4	186)	Brush_long
47)	Muted_Gtr2	117)	Fantasy_5	187)	Brush
48)	Dist_Gtr	118)	VoiceBells	188)	Roll
49)	Acous_Bass	119)	Vocal_Brth	189)	Tom_normal
50)	Elect_Bass	120)	Voice_Glk	190)	Tom_gated
51)	Pick_Bass	121)	Angels	191)	Tom_room
52)	Fretless_B	122)	Atmosphere	192)	House_bdrum
53)	Slap_Bass1	123)	Noise	193)	House_sdrm
54)	Slap_Bass2	124)	Breath	194)	House_hhat
55)	Cello_Viol	125)	Syn_perc1	195)	House_ride
56)	Strings	126)	Syn_Perc2	196)	House_clap
57)	Pizz_Str	127)	Syn_Perc3	197)	HH_closed1
58)	Harp	128)	Syn_Perc4	198)	HH_open_1
59)	Timpani	129)	Syn_Perc5	199)	HH_closed2
60)	Str_Glockn	130)	Syn_Perc6	200)	HH_open_2
61)	Orch_Str	131)	Syn_Perc7	201)	HH_pedal
62)	Choir_1	132)	Syn_perc8	202)	Ride_cymb
63)	Choir_2	133)	Syn_Perc9	203)	Ride_cup
64)	Vocalboy	134)	Drop	204)	Crash
65)	Symphony	135)	Water	205)	China
66)	Symph_Orch	136)	Voice_1	206)	Splash
67)	Trumpet	137)	Voice_2	207)	Trian_long
68)	Flugelhorn	138)	Voice_3	208)	Trian_shrt
69)	Trombone	139)	Vox_HH_CI	209)	Empty
70)	Muted_Trp1	140)	Vox_Tap		

THE ROM SOUND MAP

The Sound Library The table shown in the pages which follow represents the Sound Library that resides in the instrument’s ROM, and which is automatically loaded into memory when the instrument is powered up in the following conditions:

- no floppy disk inserted in the disk drive, or the disk inserted does not contain a Sound Library;
- The RAM-disk, if installed, is empty, or does not contain a Sound Library.

Reading the tables The Sounds are organised in 16 Families, which group together 16 sound of the same type. The Families conform to General MIDI standards, with the exception of the last family (“Drumkits”) which replaces the GM “Special FX”.

The Sounds are arranged vertically in increasing order of Program Change number and in horizontal direction, in increasing order of Bank Select number. The Extended Program Change of the S Series—exploited in Songs to recall Sounds—groups these two values in a single parameter (the Program Change is the first part and the Bank Select is the second).

Sounds with 32 note polyphony Sounds shown in grey are Single Oscillator Sounds (SO), which permits a maximum polyphony of 32 notes. Consult the *Edit Sound* chapter in the *Reference* section for detailed information.

This table can be photocopied and used to list the Sounds loaded into RAM and saved in a user-programmed Sound Library. The last page shows a blank table.

A table listing the Performances contained in ROM follows after the ROM Sounds. Here also you will find two blank tables that can be photocopied for personal use.

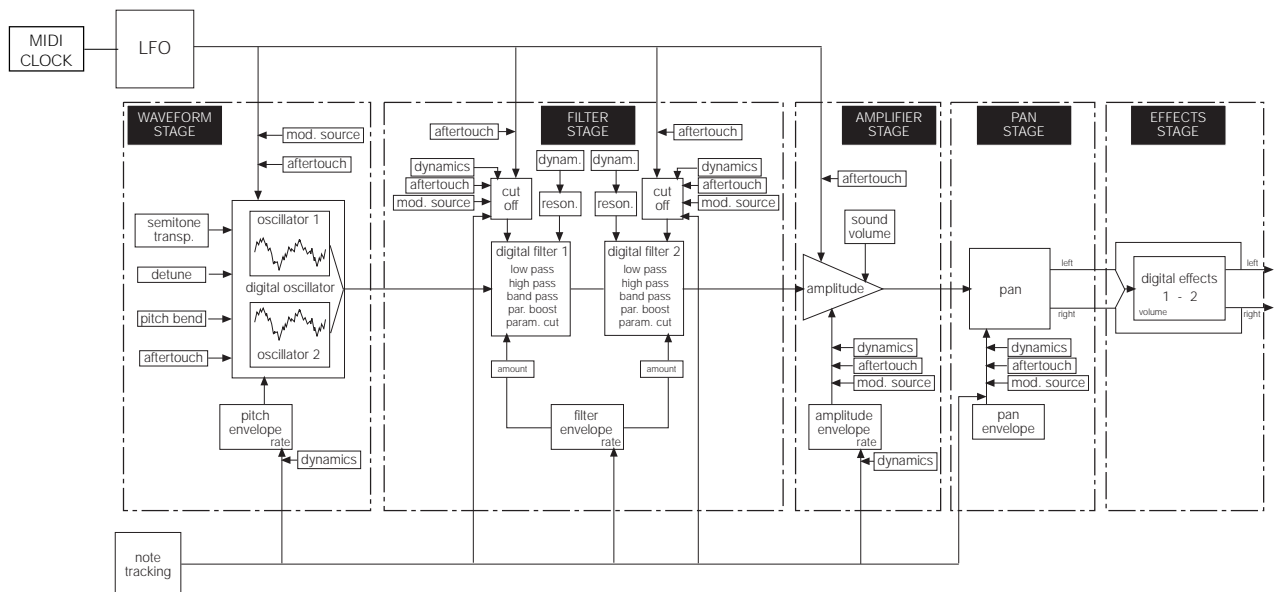

Diagram showing the development of a DC Sound

	1	2	3	4	5	6	7	8
PIANO Family								
1	GrandPiano	Env_Piano						
2	Brt_Piano							
3	El_GrPiano	ElGrPiano						
4	Honky_Tonk	Western						
5	El_Piano_1	El_Piano_2	Rhodx	El_P_Chim	ElPiano_32	Syn_El_P1	Syn_El_P2	
6	El_Piano_3	El_Piano_4	El_Piano_5	Det_Piano	El_Piano_6	El_Piano_7	El_P_Glock	
7	Harpsich_1	Harpsich_2	Harpsich32					
8	Clavinet	Syn_Clav_1	Syn_Clav_2	Wawaclav	Clav_Filt	Clavinet32		
CHROMATIC PERCUSSION Family								
9	Celesta	CelestaPlk	Kocis					
10	Glockenspl	Attack	Glockensp2					
11	Music_Box	Wine_Gls1	Wine_Gls2					
12	Vibraphone	Syn_Vibes	Vibes_2					
13	Marimba	Marimba_32						
14	Xylophone	Xylophon32						
15	Tub_Bells	SharpBells	HappyBells					
16	Dulcimer	Barchimes	Ooh_Lalaa	DrunkChime				
ORGAN Family								
17	TheatreOrg	Organ_1	Organ_2	Organ_3	Organ_4	Organ_5	Organ_6	TheatOrg32
18	JazzOrgan1	JazzOrgan2	Syn_Organ	Jazz_Org32				
19	Rock_Organ	RockOrg_32						
20	Pipe_Org_1	Pipe_Org_2						
21	Pipe_Org_3							
22	Accordion	Accord_32						
23	Harmonica	Toots						
24	Bandoneon	Accordion2	Musette					
GUITAR Family								
25	Nyl_Guitar	Vocal_Gtr	Dyn_Gtr	Solo_A_Gtr	EspaNoise	Nyl_Gtr32	Spanish	
26	Steel_Gtr	12_Str_Gtr	SteelGtr32					
27	Jazz_Gtr_1	Jazz_Gtr_2	Oct_Jz_Gtr	Vangel_Gtr	Syn_Guitar	Jazz_Gtr_3	George	
28	Elect_Gtr	Chorus_Gtr	Hawai_Gtr					
29	Muted_Gtr1	Muted_Gtr2	Dyn_M_Gtr	MultiPluck	FunkGtr_32	Wha_Gtr1	Wha_Gtr2	
30	Overdr_Gtr	Power_Gtr						
31	Dist_Gtr							
32	Harm_Gtr	NewHarmGtr						
BASS Family								
33	Acous_Bass	AcoBass_32	NewAcoBass					
34	Elect_Bass	Dyn_Bass_1	El_Bass_32					
35	Pick_Bass	Dyn_Bass_2	PickBass_Q					
36	Fretless_B	SynFretls						
37	Slap_Bass1	Dyn_Slap_B	Stanley	SlapB_32_1	Expres_Slp			
38	Slap_Bass2	Slap_B_2	SlapB_32_2					
39	Syn_Bass_1	Syn_Bass_2	Anl_Bass_1	Anl_Bass_2	Anl_Bass_3	OldSynBas1	OldSynBas2	FilterBass
40	Moog_Bass	Syn_Bass_3	Syn_Bass_4	Syn_Bass_5	FM_Bass_1	FM_Bass_2	Syn_Bass_6	Syn_Bass_7

	9	10	11	12	13	14	15	16
1								
2								
3								
4								
5								
6								
7								
8								
9								
10								
11								
12								
13								
14								
15								
16								
17								
18								
19								
20								
21								
22								
23								
24								
25								
26								
27								
28								
29								
30								
31								
32								
33								
34								
35								
36								
37								
38								
39								
40	Seq_Bass							

	1	2	3	4	5	6	7	8
<i>STRINGS Family</i>								
41	Violin							
42	Viola							
43	Cello							
44	Contrabass							
45	TremoloStr							
46	Pizz_Str							
47	Harp							
48	Timpani	Dyn_Orch						
<i>ENSEMBLE Family</i>								
49	Strings_1	Str_Glockn	Strings_32					
50	Strings_2	Orch_Str						
51	Synth_Str1	Synth_Str2						
52	Synth_Str3	Synth_Str4						
53	Choir	Choir_32						
54	Voice_Oohs	LyriconØØ						
55	SynthVoice	Anl_Voice	Vocoder_1	Vocoder_2				
56	Symphony	Symph_Orch	Reson_Orch					
<i>BRASS Family</i>								
57	Trumpet	FlugelHorn	Trp_Swell	Trumpet_32	FlugHorn32			
58	Trombone	TrombSwel1	TrombSwel2	Trombone32				
59	Tuba							
60	Muted_Trp1	Muted_Trp2	Dyn_M_Trp	MutedTrp32				
61	FrenchHorn							
62	Brass_1	Brass_Rips	Brass_Trp	Brass_2	Brass_3	Brass_4	BrassNoise	Brass_40th
63	Syn_Brass1	Syn_Horns	New_Horns					
64	Tot_Horn_1	Tot_Horn_2	Slow_Horn	Deep_Horn				
<i>REEDS Family</i>								
65	SopranoSax	SoprSax_32						
66	Soft_Sax	SoftSax_32						
67	Tenor_Sax	TenorSax32						
68	Baritone_S	BaritSax32						
69	Oboe	Oboe_32						
70	Eng_Horn							
71	Bassoon							
72	Clarinet	Clarinet32						
<i>PIPES Family</i>								
73	Piccolo	Piccolo_32						
74	Flute	Dyn_Flute	HardFlute1	HardFlute2	Flute_32			
75	Recorder							
76	Panflute	NewPanfl	DynPanfl					
77	Bottle							
78	Shakuhachi							
79	Whistle_1	Whistle_2						
80	Ocarina	Ocarina_32						

	9	10	11	12	13	14	15	16
41								
42								
43								
44								
45								
46								
47								
48								
49								
50								
51								
52								
53								
54								
55								
56								
57								
58								
59								
60								
61								
62	BrasSwell1	BrasSwell2	BrassRip32					
63								
64								
65								
66								
67								
68								
69								
70								
71								
72								
73								
74								
75								
76								
77								
78								
79								
80								

	1	2	3	4	5	6	7	8
<i>SYNTH LEAD Family</i>								
81	Pulse_1	Pulse_2	Pulse_05	Pulse_10	Pulse_15	Pulse_20	Pulse_25	Pulse_35
82	O_B_Filter	Invasion	TriangleWv	Sinus	SadJupiter	Anl_Brass1	Anl_Brass2	Anlg_Pan
83	Arp_260000	Azimet	Syn_Lead_1	Snd_Track1	Snd_Track2	Snd_Track3	Sawix1_CM	Old_Lead
84	Chopper	Frog	Digital_1	Digital_2	Zerbino	AnalogiX	Analog_Y	Joe
85	Jump_00	Jump_01	Break_00	Cluster	Reson_Park	ChoOrg	Lyle	
86	FilterRes1	FilterRes2	Filt_LFO	FallFilter	HighP_Filt	FilterSync	Komityx	Xi_Pass_X1
87	Decay_01	Decay_02	Decay_03	Decay_04	Decay_05	Decay_06	Decay_07	
88	O_B_X_1	O_B_X_2	O_B_X_3	Sympho_FX	Old_Synth1	Old_Synth2	Pad_Sound	
<i>SYNTH PAD Family</i>								
89	Spectrum	SpectBells	Machinery	Devil	Reson_Loop			
90	Wired_Org	CityBreath	Spatial	Synkilter	CelesGlide	Inox_Sound		
91	Fantasy_1	Fantasy_2	Fantasy_3	Fantasy_4	Fantasy_5	S&H_Wave		
92	VoiceBells	Vocal_Brth	Voice_Glk	Angels	Atmosphere	AirlinePad	Atmosph_CM	
93	Alien	Pitch	Galaxy					
94	Prophet_1	Prophet_2	Pops_1	Quauh_01				
95	Slave	Muted_City						
96	Waiting	SpaceWorld	Power_Bad	Budweis				
<i>EFFECTS Family</i>								
97	Noise_Res	Submarine	ZAP--00	Big_Room				
98	Lunar_Wind							
99	Wind	Jets						
100	Breath		Shot1					
101	Resonance	WithGas	On/Off					
102	NoGravity	Popop_1	UnderWater	PopUp_2				
103	SYNTHEX_1	SYNTHEX_2	SYNTHEX_3	SYNTHEX_4	SYNTHEX_5			
104	Helicopter							
<i>ETHNIC Family</i>								
105	Syn_Perc_1							
106	Syn_Perc_2							
107	Syn_Perc_3							
108	Syn_Perc_4							
109	Syn_Perc_5							
110	Syn_Perc_6							
111	Syn_Perc_7							
112	Syn_Perc_8	Syn_Perc_9						
<i>PERCUSSIVE Family</i>								
113	Drop	Water	Voice_1	Voice_2	Voice_3	Vox_HH_CI	Vox_Tap	Vox_Tip
114	Agogo	Conga_Acc	Conga	Conga_Slap	Cowbell	Bongos	Darbuka_Hi	DarbukaLow
115	Bdrum_Elet	Bdrum_Gate	Bdrum_Hard	Bdrum_Jazz	Bass_Drum1	Bass_Drum2	Bd_Boost_Q	El_Bd_Res
116	Woodblock	Claves	FingerSnap	Stick	Sd_FiltCut	Sdrum_Filt	RimSh_FltQ	ElectricSd
117	Snr_Drum1	Snr_Drum2	Sdrum_Rim1	Sdrum_Rim2	Concert_Sd	Rimshot	Snare_El_1	Snare_El_2
118	Tom	Gated_Tom	Tom_Room	Tom_Reson	CowbellRes	Sd_Reson	Tom_Room_2	Electr_Tom
119	HouseBdrum	HouseSdrum	House_Hhat	House_Ride	House_Clap	Hh_Filter1	HhOpen_Res	Crash_Res
120	Hh_Closed1	Hh_Open_1	Hh_Closed2	Hh_Open_2	Hh_Pedal	Ride	Ride_Cup	Crash

	9	10	11	12	13	14	15	16
81	Pulse_40	Pulse_45	Pulse_Harp	Space_Harp	Celestial	Pulse_32		
82	Anlg_Synth	Synt_Res1	Waveaura	Analog_1	SyntSquare	Mooog_Wv	Sinus_32	MooXLoopX
83	Soft_Sound	SimpLead	Sharp_CM	Sawix2_CM	Sawix3_CM			
84	ChopRes							
85								
86								
87								
88								
89								
90								
91								
92								
93								
94								
95								
96								
97								
98								
99								
100								
101								
102								
103								
104								
105								
106								
107								
108								
109								
110								
111								
112								
113	Car_Horn	Door	Raspy_Ride	Baby_Vox	Dolly_Vox	Kitchen	Log_Drum	Noise_Perc
114	Guiro	Guica_High	Guica_Low	Vibraslap	Castanets	Tambourine	Timbales	Cabasa
115	Bd_Filters	Steeldrum	BDrumShort	Bd_Rock_1	Hard_BDrum	BD_Equaliz		
116								
117	Sd_Brush_1	Sd_Brush_2	Brush_Long	Brush	Roll	SynthSnare	Sd_HPF_Res	Sd_Filters
118			BrushNoise					
119	TambouRes	Splash_Res	Rev_Cymb					
120	China	Splash	Trian_Long	TrianShort	Hh_Open_3	HhClosed_3	Cup_Reson	Ride_R

	1	2	3	4	5	6	7	8
<i>DRUM KITS Family</i>								
121	Drum_Kit1	Drum_Kit2	Drum_Kit3	Drum_Kit4	Standard			
122	Drum_Kit5				Room_Kit			
123	Drum_Kit6				Power_Kit			
124	Drum_Kit7				Electr_Kit			
125	Drum_Kit8				HouseDrums			
126	Jazz_Kit				Jazz_Drums			
127	House_Kit	Drum_Filt			Brush_Kit			
128	Drum_WS				OrchestrKit			

LIST OF THE PERFORMANCES CONTAINED IN ROM

BANK/SONG PERFORMANCE	1	2	3	4	5
1	Europe	Great Xpectat.	Techno Vintage	Ouverture	Soloist
2	Toy Land	Hurry Up	Pink Sunrise	Midi Guitar	Aliens
3	Developement	Summer Journey	Mad Hatter	Unstable	Monolith
4	Total Horn	Smoothing	Doom Ballade	Scamp Stabs	Odyssey
5	More	Deep Quiet	UHMM Keys	Fat Butterfly	Saucer
6	Underground	Thin Shocks	Glass Vibe	Alias	Sound Track
7	Mega Track	Loom Voice	Mutant Stab	ChopChop	SYNTHEx
8	Demo Perf 1	Lone Voice	Bad Pad	Solar Light	Space Solo
9	Demo Perf 2	Lunar Sea	Drilling Solo	Lunar Happyness	Ambient
10	LOCAL OFF	Black Event	Twilight Tale	On Alert	Morning

BANK/SONG PERFORMANCE	6	7	8	9	10
1	Maneater	Solar Wind	George	Analog Brass	Steps
2	Old Good Times	Cycling Frogs	Solo Accordion	Lyle	Warm Ice
3	White Organ	Vector	Solo Harmonica	Fall Interlude	Assembly
4	Circle	Gelid Line	Solo Violin	5th Combo	Soft Flight
5	Modern Organ	Sea Wake	Solo Sax	Pleyades	Buddy Neck
6	Expressive Organ	Winter Age	Solo Clarinet	Grand Entering	Strya Strings
7	Smooth	Alien Man	Solo Panflute	Tropical Nights	Deeper
8	Anglican	Blue Passage	The Real Vibe	Let's Solo	Gas Danger
9	Light Sound	Pad Sound	Old Century	Equinox	Clavinet
10	Planets	New City	Church	Dark Quack	Crisp Ends

	9	10	11	12	13	14	15	16
121								
122								
123								
124								
125								
126								
127								
128							Empty	

Disk: _____ Author: _____ Notes: _____

BANK/SONG PERFORMANCE	1	2	3	4	5
1					
2					
3					
4					
5					
6					
7					
8					
9					
10					

BANK/SONG PERFORMANCE	6	7	8	9	10
1					
2					
3					
4					
5					
6					
7					
8					
9					
10					

DRUMKITS AND PERCUSSION SAMPLES

THE DRUMKITS OF THE STANDARD SOUND LIBRARY

Voice_2 113-4
 Submarine 97-2
 Resonance 101-1
 Snare_EI_2 117-8
 Stick 116-4
 Kitchen 113-14
 Bass_Drum 1 115-5
 Bdrum_Gate 115-2
 Snr_Drum2 117-2
 Snare_EI_1 117-7
 Tom L 118-1
 Gated_Tom L 118-2
 Tom M 118-1
 Gated_Tom M 118-2
 Tom H 118-1
 Gated_Tom H 118-2
 Ride_Cup 120-7
 Splash 120-10
 Crash L 120-8
 Ride L 120-6
 Bongos H 114-6
 Conga_Acc 114-2
 Conga L 114-3
 Timbales H 114-15
 Agogo H 114-1
 Cabasa 114-16
 Whistle_1 H 79-1
 Whistle_1 L 79-1
 Guiro L 114-9
 Woodblock H 116-1
 Woodblock L 116-1
 Quica_Low 114-11
 Trian_Long 120-11
 Tub_Bells 15-1
 Barchimes 16-2
 Darbuka_Hi 114-7
 Drop 113-1
 Water 113-2
 Vox_Tap 113-7
 Car_Horn 113-9
 Raspy_Ride 113-11
 Baby_Vox 113-12
 Alien 93-1
 Helicopter 104-1
 Noise_Perc 113-16
 Logdrum 113-15
 Dolly_Vox 113-13
 Rimshot 117-6
 House_Clap 119-5
 Hh_Closed1 120-1
 Hh_Pedal 120-5
 Hh_Open_1 120-2
 Crash H 120-8
 Ride H 120-6
 Tambourine 114-14
 Cowbell 114-5
 Vibraslap 114-12
 Bongos L 114-6
 Conga H 114-3
 Timbales L 114-15
 Agogo L 114-1
 FingerSnap 116-3
 Guiro H 114-9
 Claves 116-2
 Quica_High 114-10
 TrianShort 120-12
 Vox_HH_CI 113-6
 Castanets 114-13
 Darbuka_Low 114-8
 Voice_1 113-3
 Vox_Tip 113-8
 Door 113-10

Drum_Kit 1 121-1

General MIDI

Voice_2 113-4
 Crash 120-8
 Tambourine 114-14
 Gated_Tom 118-2
 Stick 116-4
 Kitchen 113-14
 Bdrum_EIet 115-1
 Bass_Drum2 115-6
 Snr_Drum1 117-1
 Sdrum_Rim1 117-3
 Tom_Room L 118-3
 Gated_Tom L 118-2
 Tom_Room M 118-3
 Gated_Tom M 118-2
 Tom_Room H 118-3
 Gated_Tom H 118-2
 Ride_Cup 120-7
 Splash 120-10
 Crash L 120-8
 Ride L 120-6
 Bongos H 114-6
 Conga_Acc 114-2
 Conga L 114-3
 Timbales H 114-15
 Agogo H 114-1
 Cabasa 114-16
 Whistle1 H 79-1
 Whistle1 L 79-1
 Guiro L 114-9
 Woodblock H 116-1
 Woodblock L 116-1
 Quica_Low 114-11
 Trian_Long 120-11
 SharpBells 15-2
 DrunkChime 16-4
 Darbuka_Hi 114-7
 Drop 113-1
 Water 113-2
 Vox_Tap 113-7
 Car_Horn 113-9
 Raspy_Ride 113-11
 Baby_Vox 113-12
 Noise_Perc 113-16
 Drop 113-1
 Noise_Perc 113-16
 Logdrum 113-15
 Dolly_Vox 113-13
 Rimshot 117-6
 House_Clap 119-5
 Hh_Closed2 120-3
 Hh_Pedal 120-5
 Hh_Open_2 120-4
 Crash H 120-8
 Ride H 120-6
 Tambourine 114-14
 Cowbell 114-5
 Vibraslap 114-12
 Bongos L 114-6
 Conga H 114-3
 Timbales L 114-15
 Agogo L 114-1
 FingerSnap 116-3
 Guiro H 114-9
 Claves 116-2
 Quica_High 114-10
 TrianShort 120-12
 Vox_HH_CI 113-6
 Castanets 114-13
 DarbukaLow 114-8
 Voice_1 113-3
 Vox_Tip 113-8
 Door 113-10

Drum_Kit 2 121-2

General MIDI

Voice_2 113-4
 Crash 120-8
 Tambourine 114-14
 Gated_Tom 118-2
 Stick 116-4
 Kitchen 113-14
 Bdrum_Elet 115-1
 Bdrum_Gate 115-2
 Snare_EL1 117-7
 Snare_EL2 117-8
 Tom_Room L 118-3
 Gated_Tom L 118-2
 Tom_Room M 118-3
 Gated_Tom M 118-2
 Tom_Room H 118-3
 Gated_Tom H 118-2
 China 120-9
 Ride_Cup 120-7
 Splash 120-10
 Crash L 120-8
 Ride L 120-6
 Bongos H 114-6
 Conga_Acc 114-2
 Conga L 114-3
 Timbales H 114-15
 Agogo H 114-1
 Cabasa 114-16
 Whistle1 H 79-1
 Whistle1 L 79-1
 Guiro L 114-9
 Woodblock H 116-1
 Woodblock L 116-1
 Quica_Low 114-11
 Trian_Long 120-11
 SharpBells 15-2
 DrunkChime 16-4
 Darbuka_Hi 114-7
 Drop 113-1
 Water 113-2
 Vox_Tap 113-7
 Car_Horn 113-9
 Raspy_Ride 113-11
 Baby_Vox 113-12
 Noise_Perc 113-16
 Drop 113-1
 Noise_Perc 113-16
 Logdrum 113-15
 Dolly_Vox 113-13
 Rimshot 117-6
 House_Clap 119-5
 Hh_Closed2 120-3
 Hh_Pedal 120-5
 Hh_Open_2 120-4
 Crash H 120-8
 Ride H 120-6
 Tambourine 114-14
 Cowbell 114-5
 Vibraslap 114-12
 Bongos L 114-6
 Conga H 114-3
 Timbales L 114-15
 Agogo L 114-1
 FingerSnap 116-3
 Guiro H 114-9
 Claves 116-2
 Quica_High 114-10
 TrianShort 120-12
 Vox_HH_CI 113-6
 Castanets 114-13
 DarbukaLow 114-8
 Voice_1 113-3
 Vox_Tip 113-8
 Door 113-10

Drum_Kit 3 121-3

General MIDI

Bass_Drum1 115-1
 Bdrum_Elet 115-1
 Bdrum_Gate 115-2
 Snr_Drum2 117-2
 Sdrum_Rim1 117-3
 Snare_EL1 117-7
 Snare_EL2 117-8
 Tom L 118-1
 Tom M 118-1
 Tom H 118-1
 Hh_Closed1 120-1
 Hh_Pedal 120-5
 Hh_Open_1 120-2
 Hhose_Hhat L 119-3
 Crash 120-8
 Ride 120-6
 Cabasa 114-16
 Vox_HH_CI 113-6
 Bongos L 114-6
 DarbukaLow 114-8
 Conga L 114-3
 Conga H 114-3
 TrianShort 120-12
 Trian_Long 120-11
 Noise_Perc H 113-16
 Door 113-10
 Sdrum_Rim2 117-4
 Concert_Sd 117-5
 Bdrum_Hard 115-3
 HouseBdrum 119-1
 Snr_Drum1 117-1
 House_Sdrum 119-2
 Rimshot 117-6
 Gated_Tom L 118-2
 Gated_Tom H 118-2
 House_Hhat H 119-3
 House_Ride 119-4
 Tambourine 114-14
 China 120-9
 Ride_Cup 120-7
 House_Clap 119-5
 Bongos H 114-6
 Darbuka_Hi 114-9
 Timbales 114-15
 Timbales 114-15
 Noise_Perc L 113-16
 Raspy_Ride 113-11
 Roll 117-13

Drum_Kit 4 121-4

Korg M1

Drum Kit 5 122-1

Yamaha SY77

Notes (left to right):

- C1 24
- C2 36
- C3 48
- C4 60
- C5 72
- C6 84
- C7 96
- C8 108

Drum Sounds (left to right):

- Stick 116-4
- Kitchen 113-14
- Door 113-10
- Bdrum_Elet 115-1
- Snare_EL1 117-7
- Sdrum_Rim1 117-3
- Gated_Tom L 118-2
- Kitchen L 113-14
- Gated_Tom M 118-2
- Kitchen M 113-14
- Gated_Tom H 118-2
- Kitchen H 113-14
- China 120-9
- Ride_Cup 120-7
- Splash 120-10
- Crash L 120-8
- Ride L 120-6
- Vox_Tap L 113-7
- Conga H 114-3
- Conga L 114-3
- Timbales H 114-15
- Agogo H 114-1
- Cabasa 114-16
- Whistle1 H 79-1
- Whistle1 L 79-1
- VoiceBells L 92-1
- Machinery L 89-3
- Lunar_Wind 98-1
- Big_Room 97-4
- Fantasy_1 91-1
- Brass_Rips 62-2
- Baby_Vox 113-12
- Water 113-2
- Voice_2 113-4
- Machinery H 89-3
- Raspy_Ride 113-11
- Car_Horn 113-9
- Fantasy_3 91-3
- City_Breath 90-2

Drum Sounds (right to left):

- Noise_Perc 113-16
- Logdrum 113-15
- Dolly_Vox 113-13
- Sdrum_Rim2 117-4
- Raspy_Ride 113-11
- Hh_Closed1 120-1
- Hh_Open1 120-2
- Hh_Open_2 120-4
- Crash H 120-8
- Ride H 120-6
- Tambourine 114-14
- Cowbell 114-5
- Vibraslap 114-12
- Vox_Tap H 113-7
- Conga M 114-3
- Timbales L 114-15
- Agogo L 114-1
- FingerSnap 116-3
- Breath 100-1
- Wind 99-1
- VoiceBells H 92-1
- NoGravity 102-1
- Drop 113-1
- Castanets 114-13
- Voice_1 113-3
- WithGas 101-2
- Helicopter 104-1
- Door 113-10

Drum Sounds (far right):

- Bass_Drum1 115-1
- Bdrum_Elet 115-1
- Tom D 118-1
- Tom L 118-1
- Tom H 118-1
- Bass_Drum2 115-6
- Gated_Tom D 118-2
- Gated_Tom L 118-2
- Gated_Tom M 118-2
- Snare_EL_1 117-7
- Gated_Tom H 118-2
- Cowbell 114-5
- Hh_Closed1 120-1
- Hh_Open_1 120-2
- Crash 120-8
- Ride 120-6
- Tub_Bells L 15-1
- Tub_Bells M 15-1
- Kitchen L 113-14
- DarbukaLow 114-8
- Bottle L 77-1
- Bottle H 77-1
- Voice_1 113-3

Drum Sounds (far left):

- Bdrum_Hard 115-3
- Bdrum_Gate 115-2
- Tom M 118-1
- House_Bdrum 119-1
- Snr_Drum2 117-2
- Sdrum_Rim1 117-3
- RimShot 117-6
- House_Clap 119-5
- Cabasa 114-16
- Tambourine 114-14
- Roll 117-13
- Ride_Cup 120-7
- Tub_Bells H 15-1
- Kitchen H 113-14
- Darbuka_Hi 114-9
- Vibraslap 114-12
- Voice_1 113-3

Drum_Kit 5 122-1

Yamaha SY77

Drum Kit 6 123-1

Notes (left to right):

- C1 24
- C2 36
- C3 48
- C4 60
- C5 72
- C6 84
- C7 96
- C8 108

Drum Sounds (left to right):

- Stick 116-4
- Kitchen 113-14
- Door 113-10
- Bdrum_Elet 115-1
- Snare_EL1 117-7
- Sdrum_Rim1 117-3
- Gated_Tom L 118-2
- Kitchen L 113-14
- Gated_Tom M 118-2
- Kitchen M 113-14
- Gated_Tom H 118-2
- Kitchen H 113-14
- China 120-9
- Ride_Cup 120-7
- Splash 120-10
- Crash L 120-8
- Ride L 120-6
- Vox_Tap L 113-7
- Conga H 114-3
- Conga L 114-3
- Timbales H 114-15
- Agogo H 114-1
- Cabasa 114-16
- Whistle1 H 79-1
- Whistle1 L 79-1
- VoiceBells L 92-1
- Machinery L 89-3
- Lunar_Wind 98-1
- Big_Room 97-4
- Fantasy_1 91-1
- Brass_Rips 62-2
- Baby_Vox 113-12
- Water 113-2
- Voice_2 113-4
- Machinery H 89-3
- Raspy_Ride 113-11
- Car_Horn 113-9
- Fantasy_3 91-3
- City_Breath 90-2

Drum Sounds (right to left):

- Noise_Perc 113-16
- Logdrum 113-15
- Dolly_Vox 113-13
- Sdrum_Rim2 117-4
- Raspy_Ride 113-11
- Hh_Closed1 120-1
- Hh_Open1 120-2
- Hh_Open_2 120-4
- Crash H 120-8
- Ride H 120-6
- Tambourine 114-14
- Cowbell 114-5
- Vibraslap 114-12
- Vox_Tap H 113-7
- Conga M 114-3
- Timbales L 114-15
- Agogo L 114-1
- FingerSnap 116-3
- Breath 100-1
- Wind 99-1
- VoiceBells H 92-1
- NoGravity 102-1
- Drop 113-1
- Castanets 114-13
- Voice_1 113-3
- WithGas 101-2
- Helicopter 104-1
- Door 113-10

Drum Sounds (far right):

- Bass_Drum1 115-1
- Bdrum_Elet 115-1
- Tom D 118-1
- Tom L 118-1
- Tom H 118-1
- Bass_Drum2 115-6
- Gated_Tom D 118-2
- Gated_Tom L 118-2
- Gated_Tom M 118-2
- Snare_EL_1 117-7
- Gated_Tom H 118-2
- Cowbell 114-5
- Hh_Closed1 120-1
- Hh_Open_1 120-2
- Crash 120-8
- Ride 120-6
- Tub_Bells L 15-1
- Tub_Bells M 15-1
- Kitchen L 113-14
- DarbukaLow 114-8
- Bottle L 77-1
- Bottle H 77-1
- Voice_1 113-3

Drum Sounds (far left):

- Bdrum_Hard 115-3
- Bdrum_Gate 115-2
- Tom M 118-1
- House_Bdrum 119-1
- Snr_Drum2 117-2
- Sdrum_Rim1 117-3
- RimShot 117-6
- House_Clap 119-5
- Cabasa 114-16
- Tambourine 114-14
- Roll 117-13
- Ride_Cup 120-7
- Tub_Bells H 15-1
- Kitchen H 113-14
- Darbuka_Hi 114-9
- Vibraslap 114-12
- Voice_1 113-3

Drum_Kit 6 123-1

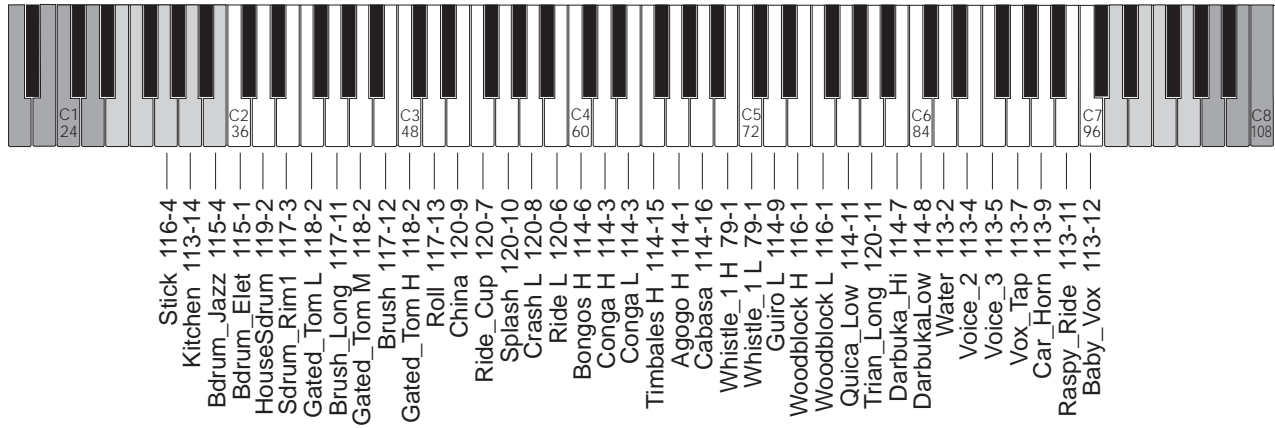

Drum_Kit 7 124-1

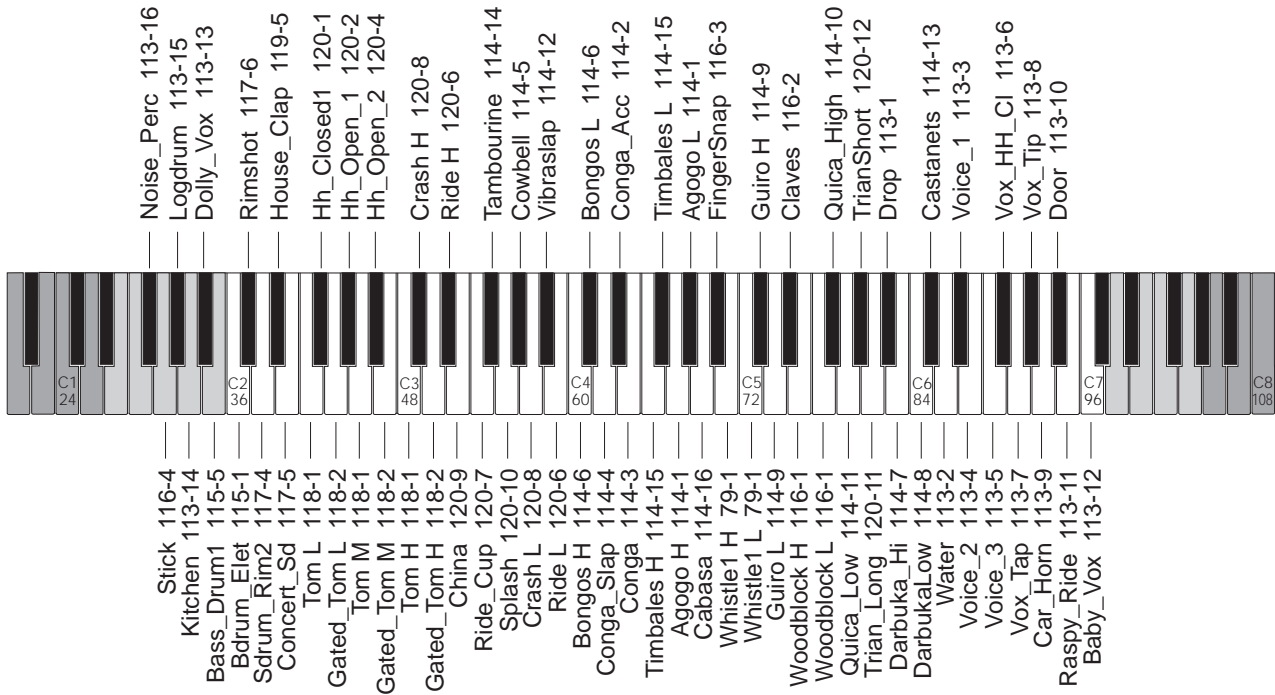

Drum_Kit 8 125-1

Noise_Perc 113-16
Logdrum 113-15
Dolly_Vox 113-13
Rimshot 117-6
House_Clap 119-5
Hh_Closed1 120-1
Hh_Open_1 120-2
Hh_Open_2 120-4
Crash H 120-8
Ride H 120-6
Tambourine 114-14
Cowbell 114-5
Vibraslap 114-12
Bongos L 114-6
Conga M 114-3
Timbales L 114-15
Agogo L 114-1
FingerSnap 116-3
Guiro H 114-9
Claves 116-2
Quica_High 114-10
TrianShort 120-12
Drop 113-1
Castanets 114-13
Voice_1 113-3
Vox_HH-CI 113-6
Vox_Tip 113-8
Door 113-10

Noise_Perc 113-16
Logdrum 113-15
Dolly_Vox 113-13
Rimshot 117-6
House_Clap 119-5
Hh_Closed1 120-1
Hh_Open_1 120-2
Hh_Open_2 120-4
Crash H 120-8
Ride H 120-6
Tambourine 114-14
Cowbell 114-5
Vibraslap 114-12
Bongos L 114-6
Conga M 114-3
Timbales L 114-15
Agogo L 114-1
FingerSnap 116-3
Guiro H 114-9
Claves 116-2
Quica_High 114-10
TrianShort 120-12
Drop 113-1
Castanets 114-13
Voice_1 113-3
Vox_HH-CI 113-6
Vox_Tip 113-8
Door 113-10

Voice_2 113-4
Submarine 97-2
Resonance 101-1
Snare_El_2 117-8
Stick 116-4
Kitchen 113-14
Bass_Drum1 115-5
Bdrum_Jazz 115-4
Sd_Brush_1 117-9
Sd_Brush_2 117-10
Tom L 118-3
Brush_Long 117-11
Tom M 118-1
Brush 117-12
Tom H 118-1
Roll 117-13
China 120-9
Ride_Cup 120-7
Splash 120-10
Crash L 120-8
Ride L 120-6
Bongos H 114-6
Conga_Slap 114-4
Conga M 114-3
Conga H 114-3
Agogo H 114-1
Cabasa 114-16
Whistle1 H 79-1
Whistle1 L 79-1
Guiro L 114-9
Woodblock H 116-1
Woodblock L 116-1
Quica_Low 114-11
Trian_Long 120-11
TubBells 15-1
BarChimes 16-2
Darbuka_Hi 114-7
Drop 113-1
Water 113-2
Vox_Tap 113-7
Car_Horn 113-9
Raspy_Ride 113-11
Baby_Vox 113-12

Alien 93-1
Helicopter 104-1
Noise_Perc 113-16
Logdrum 113-15
Dolly_Vox 113-13
Rimshot 117-6
Sdrum_Rim1 117-3
Hh_Closed1 120-1
Hh_Pedal 120-5
Hh_Open_1 120-2
Crash H 120-8
Ride H 120-6
Tambourine 114-14
Cowbell 114-5
Vibraslap 114-12
Bongos L 114-6
Conga_Acc 114-2
Conga H 114-3
Agogo L 114-1
FingerSnap 116-3
Guiro H 114-9
Claves 116-2
Quica_High 114-10
TrianShort 120-12
Vox_HH_CI 113-6
Castanets 114-13
DarbukaLow 114-8
Voice_1 113-3
Vox_Tip 113-8
Door 113-10

Jazz_Kit 126-1

Voice_2 113-4
Submarine 97-2
Resonance 101-1
Snare_El_2 117-8
Stick 116-4
Kitchen 113-14
Bass_Drum 1 115-5
HouseBdrum 119-1
HouseSdrum 119-2
Concert_Sd 117-5
Tom L 118-1
Gated_Tom L 118-2
Tom M 118-1
Gated_Tom M 118-2
Gated_Tom H 118-1
Gated_Tom H 118-2
Gated_China 120-9
Ride_Cup 120-7
Splash 120-10
Crash L 120-8
Ride 120-6
Bongos H 114-6
Conga H 114-3
Conga L 114-3
Timbales H 114-15
Agogo H 114-1
Cabasa 114-16
Whistle_1 H 79-1
Whistle_1 L 79-1
Guiro L 114-9
Woodblock H 116-1
Woodblock L 116-1
Quica_Low 114-11
Trian_Long 120-11
Tub_Bells 15-1
BarChimes 16-2
Darbuka_Hi 114-7
Drop 113-1
Water 113-2
Vox_Tap 113-7
Car_Horn 113-9
Raspy_Ride 113-11
Baby_Vox 113-12

Alien 93-1
Helicopter 104-1
Noise_Perc 113-16
Logdrum 113-15
Dolly-Vox 113-13
Rimshot 117-6
House_Clap 119-5
House_Hhat H 119-3
House_Hhat L 119-3
Vox_HH_CI L 113-6
House_Ride 119-4
Crash H 120-8
Tambourine 114-14
Cowbell 114-5
Vibraslap 114-12
Bongos L 114-6
Conga M 114-3
Timbales L 114-15
Agogo L 114-1
FingerSnap 116-3
Guiro H 114-9
Claves 116-2
Quica_High 114-10
TrianShort 120-12
Vox_HH_CI H 113-6
Castanets 114-13
Darbuka_Low 114-8
Voice_1 113-3
Vox_Tip 113-8
Door 113-10

House_Kit 127-1

GS TR-808

Bdrum_Gate 115-2
 Snare_EL1 117-7
 Tom_RoomD 118-3
 Tom_Room L 118-3
 Tom_Room M 118-3
 Tom_Room H 118-3
 Rimshot 117-6
 Bdrum_Jazz 115-4
 Sd_Brush_1 117-9
 Tom L 118-1
 Tom H 118-1
 Tom M 118-1
 Woodblock 116-1
 House_Clap 119-5
 Bass_Drum1 115-5
 Snr_Drum2 117-2
 Gated_Tom L 118-2
 Gated_Tom M 118-2
 Gated_Tom H 118-2
 Vibraslap 114-12
 FingerSnap 116-3
 Bongos H 114-6
 Conga_Slap 114-4
 Conga L 114-3
 Guiro 114-3
 Timbales H 114-15
 Agogo 114-1
 Whistle_1 79-1
 HouseBdrum 119-1
 HouseSdrum 119-2
 Voice_3 113-5
 Voice_2 L 113-4
 Voice_2 H 113-4
 Vox_Tip 113-8
 Car_Horn 113-9
 Dolly_Vox 113-13
 Roll 117-13
 Hh_Closed1 120-1
 Claves 116-2
 Quica_High 114-10
 Stick H 116-4
 Stick L 116-4
 Sticks 116-4

Drum_WS 128-1

GEM WS2

Drum_Filt 127-2

Stick 116-4
 Kitchen 113-14
 Bass_Drum2 115-6
 BD_Equaliz 115-14
 Sdrum_Filt 116-6
 SD_HPF_Res 117-15
 Tom_Reson 118-4
 Tom_Reson 118-4
 Tom_Reson 118-4
 Tom_Reson 118-4
 Tom_Reson 118-4
 Tom_Reson 118-4
 Tom_Reson 118-4
 China 120-9
 Cup_Reson 120-15
 Splash_Res 119-10
 Splash 120-10
 Ride_Cup 120-7
 Bongos 114-6
 Conga_Acc 114-2
 Conga 114-3
 Timbales 114-15
 Agogo 114-1
 Cabasa 114-16
 Whistle_1 79-1
 Whistle_1 79-1
 Guiro 114-9
 Woodblock 116-1
 Woodblock 116-1
 Quica_Low 114-11
 Trian_Long 120-11
 Darbuka_Hi 114-7
 Darbukalow 114-8
 Water 113-2
 Voice_2 113-4
 Voice_3 113-5
 Vox_Tap 113-7
 Car_Horn 113-9
 Raspy_Ride 113-11
 Baby_Vox 113-12

Noise_Perc 113-16
 Logdrum 113-15
 Dolly_Vox 113-13
 RimSh_FitQ 116-7
 BD_Reson 118-6
 Hh_Filter1 119-6
 Hh_Open_Res 119-7
 Hh_Open_Res 119-7
 Crash_Res 1119-8
 Ride_R 120-16
 TambouRes 119-9
 CowbellRes 118-5
 Vibraslap 114-12
 Bongos 114-6
 Conga 114-3
 Timbales 114-15
 Agogo 114-1
 Vox_HH_CI 113-6
 Guiro 114-9
 Claves 116-2
 Quica_High 114-10
 TrianShort 120-12
 Drop 113-1
 Castanets 114-13
 Voice_1 113-3
 Vox_HH_CI 113-6
 Vox_Tip 113-8
 Door 113-10

Alien 93-1
Helicopter 104-1
Noise_Perc 113-16
Logdrum 113-15
Dolly_Vox 113-13

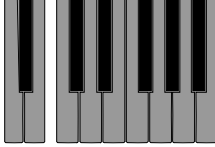

Voice_2 113-4
Submarine 97-2
Resonance 101-1
Snare_EL2 117-8
Stick 116-4
Kitchen 113-14
Bd_Boost_Q 115-7

Rimshot 117-6
House_Clap 119-5
House_Hhat 119-3
House_Hhat 119-3
House_Ride 119-4

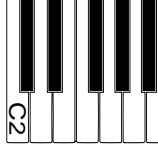

HouseBdrum 119-1
HouseSdrum 119-2
Snare_EL1 117-7
HouseBdrum 119-1
House_Bdrum 119-1
HouseBdrum 119-1
HouseBdrum 119-1

Ride_R 120-16
Ride 120-6
Tambourine 114-14
Cowbell 114-5
Vibraslap 114-12

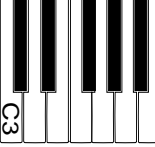

HouseBdrum 119-1
HouseBdrum 119-1
China 120-9
Ride_Cup 120-7
Splash 120-10
Crash 120-8
Ride 120-6

Bongos 114-6
Conga 114-3
Timbales 114-15
Agogo 114-1
Vox_HH_CI 113-6

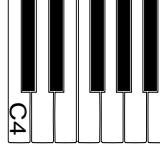

Bongos 114-6
Conga_Acc 114-2
Conga 114-3
Timbales 114-15
Agogo 114-1
Cabasa 114-16
Whistle_1 79-1

Guero 114-9
Claves 116-2
Quica_High 114-10
TrianShort 120-12
Vox_HH_CI 113-6

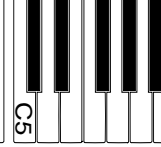

Whistle_1 79-1
Guero 114-9
Woodblock 116-1
Woodblock 116-1
Quica_Low 114-11
Trian_Long 120-11
Tub_Bells 15-1

Castanets 114-13
DarbukaLow 114-8
Voice_1 113-3
Vox_Tip 113-8
Door 113-10

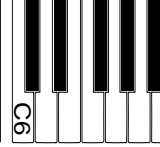

Barchimes 16-2
Darbuka_Hi 114-7
Drop 113-1
Water 113-2
Vox_Tap 113-7
Car_Horn 113-9
Raspy_Ride 113-11

Baby_Vox 113-12

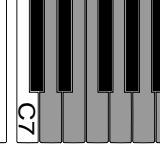

Baby_Vox 113-12

HouseDrums 125-5

GS House Drums

Alien 93-1
Helicopter 104-1
Noise_Perc 113-16
Logdrum 113-15
Dolly_Vox 113-13

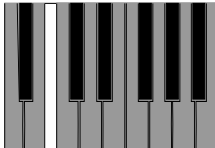

Voice_2 113-4
Submarine 97-2
Resonance 101-1
Snare_EL2 117-8
Stick 116-4
Kitchen 113-14
Bass_Drum1 115-5

Rimshot 117-6
Sdrum_Rim1 117-3
Hh_Closed2 120-3
Hh_Pedal 120-5
Hh_Open_1 120-2

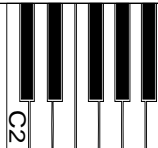

Bdrum_Jazz 115-4
Sd_Brush_1 117-9
Sd_Brush_2 117-10
Tom 118-1
Tom 118-1
Tom 118-1
Tom 118-1
Tom 118-1

Crash 120-8
Ride 120-6
Tambourine 114-14
Cowbell 114-5
Vibraslap 114-12

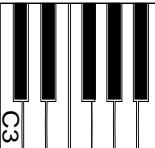

Tom 118-1
Tom 118-1
China 120-9
Ride_Cup 120-7
Splash 120-10
Crash 120-8
Ride 120-6

Bongos 114-6
Conga 114-3
Timbales 114-15
Agogo 114-1
Vox_HH_CI 113-6

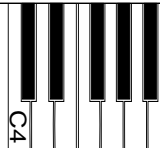

Bongos 114-6
Conga_Acc 114-2
Conga 114-3
Timbales 114-15
Agogo 114-1
Cabasa 114-16
Whistle_1 79-1

Guero 114-9
Claves 116-2
Quica_High 114-10
TrianShort 120-12
Vox_HH_CI 113-6

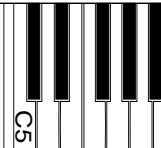

Whistle_1 79-1
Guero 114-9
Woodblock 116-1
Woodblock 116-1
Quica_Low 114-11
Trian_Long 120-11
Tub_Bells 15-1

Castanets 114-13
DarbukaLow 114-8
Voice_1 113-3
Vox_Tip 113-8
Door 113-10

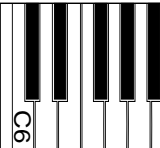

Barchimes 16-2
Darbuka_Hi 114-7
FingerSnap 116-3
Water 113-2
Vox_Tap 113-7
Car_Horn 113-9
Raspy_Ride 113-11

Baby_Vox 113-12

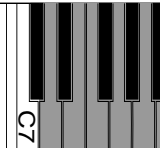

Baby_Vox 113-12

Jazz_Drums 126-5

GS Jazz Drums

PERCUSSION SAMPLES

This table lists the percussion samples resident in the instrument's ROM (the relative Waveforms appear last in the Waveform list).

Each sample is listed with a sample note, which corresponds to the frequency which provides optimum timbre quality. As you move further away from this note, the sample assumes particular characteristics and its quality gradually decays.

Using samples on notes that differ to the original sample note is effective in cases which involve tuning a percussion instrument (for example, Toms and Cymbals) or with percussion sounds of synthetic origin (Door, Logdrum, Noise_Perc).

In a Drumkit, the samples are transposed until they are taken to the optimum level, or to a level that obtains a particular effect.

Timpani	<i>E4</i>	Bass_Drum2	<i>C4</i>
Whistle_1	<i>E4</i>	Woodblock	<i>C4</i>
Drop	<i>G4</i>	Claves	<i>C4</i>
Water	<i>E4</i>	Fingersnap	<i>E5</i>
Voice_1	<i>E4</i>	Stick	<i>E4</i>
Voice_2	<i>E4</i>	Snr_Drum1	<i>E5</i>
Voice_3	<i>E4</i>	Snr_Drum2	<i>E5</i>
Vox_HH_C1	<i>E5</i>	Sdrum_Rim1	<i>C5</i>
Vox_Tap	<i>C4</i>	Sdrum_Rim2	<i>E5</i>
Vox_Tip	<i>C4</i>	Concert_Sd	<i>B4</i>
Car_Horn	<i>C4</i>	Rimshot	<i>C4</i>
Door	<i>G4</i>	Snare_El_1	<i>G4</i>
Raspy_Ride	<i>G4</i>	Snare_El_2	<i>G4</i>
Baby_Vox	<i>E4</i>	Sd_Brush_1	<i>E4</i>
Dolly_Vox	<i>C4</i>	Sd_Brush_2	<i>E4</i>
Kitchen	<i>E4</i>	Brush_Long	<i>C4</i>
Logdrum	<i>C4</i>	Brush	<i>C5</i>
Noise_Perc	<i>C5</i>	Roll	<i>E4</i>
Agogo	<i>G4-C5</i>	SynthSnare	<i>E4</i>
Conga_Acc	<i>E4</i>	Tom	<i>E4</i>
Conga	<i>C4</i>	Gated_Tom	<i>G4</i>
Conga_Slap	<i>E4</i>	Tom_Room	<i>E4</i>
Cowbell	<i>G4</i>	HouseBdrum	<i>C4</i>
Bongos	<i>G4-C5</i>	HouseSdrum	<i>E4</i>
Darbuka_Hi	<i>E4</i>	House_Hhat	<i>E5</i>
DarbukaLow	<i>C4</i>	House_Ride	<i>E5</i>
Guiro	<i>E4</i>	House_Clap	<i>C4</i>
Quica_High)	<i>C4</i>	Hh_Closed1	<i>E5</i>
Quica_Low	<i>C4</i>	Hh_Open_1	<i>E5</i>
Vibraslap	<i>E4</i>	Hh_Closed_2	<i>E5</i>
Castanets	<i>E4</i>	Hh_Open_2	<i>E5</i>
Tambourine	<i>C5</i>	Hh_Pedal	<i>E5</i>
Timbales	<i>E4</i>	Ride	<i>E5</i>
Cabasa	<i>E5</i>	Ride_Cup	<i>E5</i>
Bdrum_Elet	<i>B4</i>	Crash	<i>E5</i>
Bdrum_Gate	<i>E4</i>	China	<i>E5</i>
Bdrum_Hard	<i>E4</i>	Splash	<i>E5</i>
Bdrum_Jazz	<i>E4</i>	Trian_Long	<i>E5</i>
Bass_Drum1	<i>E4</i>	TrianShort	<i>E5</i>

TECHNICAL SPECIFICATIONS

TECHNICAL SPECIFICATIONS

Keyboard

61 notes (S2), 76 notes (S3), weighted keys (synthesizer type). Sensitive to Dynamics (Key On, Key Off) and polyphonic Aftertouch.

Sound Generation

PCM, Wavetables, Multiloop, Crossfade Multiwave and Subtractive Synthesis.

6 Megabytes of ROM-Waveforms.

2 Megabytes of Sample-RAM for RAM-Waveforms.

6 x 18 Bit Digital/analog converters (DAC).

2 Digital Effects Processors (DSP1/Reverb + DSP2/Modulation).

32 Oscillators.

Polyphony: 32 note max.. Dynamic voice allocation with assignable Priority.

16 multi-timbral parts, 16 layers (with independent dynamic Range), 16 split zones.

32 Programmable Digital Filters – 2 Filters per voice (5 types with Resonance Q: Low Pass, High Pass, Band Pass, Parametric Boost, Parametric Cut).

Dynamic Stereo Panning.

S/N ratio: >96dB (referred to the 'Sinus' Waveform).

Dynamics: >96dB.

Passing Band: 10Hz~18KHz.

Sampling Rate: 41.7 KHz.

Controllers

S2/S3: 2 Wheels, 2 Foot controllers, 7 Function Keys and 7 Function Sliders, all programmable.

S2R: 2 Programmable Foot controllers.

All: Volume Pedal.

Internal Elaboration

Microprocessor: Motorola MC68302 (16 MHz).

2 Mbytes of Operative-RAM, data handling tasks (except RAM-Waveforms).

Sounds Library (518 ROM Sounds + up to 1600 RAM Sounds).

DSP Effects Library (64 + 64)

100 Performances

10 Songs

Sound Patch Matrix

Display

Resolution: 240 x 64 pixels backlit.

Sequencer

Tracks: 16.

Resolution: 192 Beats Per Quarter (BPQ).

Recordable events: approx. 250.000.

Background Song loading (Preload).

Editing: Realtime, Overdub/Replace, Quantize, Realtime Delay, Microscope Editing.

Standard MIDI File compatible (on Atari/IBM floppy disks).

Disk Drive

3.5" HD (1.62 M Byte format).

Loads and saves PCM data, Sounds, Songs, Performances, DSP Effects, MIDI Files.

Loads software upgrades (User programs) and data from Akai S1000™ (Samples e Programs).

Full background operation.

MIDI

16+16 independent MIDIchannels.

2 MIDI IN, 2 MIDI THRU, 2 MIDI OUT.

MIDI-Merge.

Clock In/Out.

Transmission and reception of Samples in MMA Sample Dump Standard format.

Audio (Analog Outs)

Wet (with effects): Stereo L/R.

Dry (without effects): Stereo OUT1+OUT2, Stereo OUT3+OUT4, Mono OUT 1, 2, 3, 4.

Headphones.

Dimensions

S2: (L x A x P) - 1055 x 116 x 350 mm

S3: (L x A x P) - 1077 x 116 x 350 mm

S2R: (L x A x P) - 434 x 132,5 x 276,5 mm

Weight

S2: 16 kg

S3: 18,5 kg

S2R: 7,3 kg

GLOSSARY / ALPHABETICAL INDEX / TROUBLESHOOTING

GLOSSARY

ALPHABETICAL INDEX

TROUBLESHOOTING

Glossary

-1/<, +1/>: Buttons to increase/decrease data value by one step at a time. Also used in the name writing procedure, to move the flashing cursor left or right, or to move the reverse-highlighted zone in most edit situations.

Abort: Annul - Cancel. After carrying out the majority of the edit tasks, the Operating System asks for the confirmation or cancellation of the edit task effected, and provides a choice between Save and Abort. Abort cancels the modifications.

After Touch: MIDI message activated by applying pressure after a note on event. Its action is graduated (128 steps), and is directly proportional to the pressure applied. It is usually used to control Modulation or Volume. Aftersound in the S Series is completely programmable, as are all other controllers.

Analog Out: The analog audio output - any one of the six audio outputs located on the bank panel of S2/S3/S2R.

Bypass: To ignore, "go around". Used on the EFF. BYPASS button; when pressed (led on the button on), it cuts all DSP Effects (reverb, delay/modulations) added to sounds emitted by the Stereo outputs Left/Right. Pressed again (led off) defeats the bypass.

Clipboard: A "note pad" which is part of the S Series memory. The Clipboard can contain "clips" of Edit pages which can be used (pasted) in other similar Edit situations, and so avoid having to repeat a series of identical parameter modifications.

Common: See MIDI Common.

Controllers: Sound controlling devices (Wheels, Pedals, Function Controllers).

Cutoff Frequency: Central Frequency of the intervention band of a Filter. Around the vicinity of the Cutoff Frequency, the action of the Filter gradually becomes less marked, creating a "bell" in the audio band.

Data Entry: An operation involving the use of specific controls which insert data both in normal playing mode as well as in edit mode. The Data Entry controls include: the Dial, the -1/< and +1/> buttons, the alphanumeric keypad, the Enter and Exit buttons and the Undo button.

Delete: Cancels. It is a command found in the Disk and Edit Song environments.

Destination: Refers to all that to which a MIDI message generated by a Track can be directed. S2/S3 can direct MIDI messages to the internal Sound Generation, to MIDI Out and to the Sequencer.

Dial: The Data Entry wheel to the right of the Display. Increases or decreases Data value by large amounts (continuously). Also used to move the reverse-highlighted Edit zone in almost all applications.

Dynamics: MIDI message always coupled to the activation of a note. Dynamics controls the sound's intensity, proportionally to the keystroke velocity.

Directory: "Catalogue" of the contents of a floppy disk. In the S Series, you can see the data contained in a floppy disk inserted in the drive ("disk-dir"), in the Ram-disk ("ram-dir"), or in the instrument's RAM. The directories are divided into Setups, Bank/Songs, Performances, User Programs.

Display: The "small" monitor incorporated in the front panel of S Series. The Display permits the monitoring of all information relating to the instrument's means of control (sound generation, commands, connections). Its high resolution permits you to communicate with the musical instrument through pages rich with graphics which are easily understood.

Disk Drive: Device that "reads" a floppy disk. The disk drive is built-in and has a capacity of 1.65 Megabytes. It can also use 3.5" HD or 3.5" DD disks.

Drum Kit: Refers to the layout of the percussion sounds across the keyboard. A Drum Kit permits you to use only one Track for all the drum sounds, or for a part of them. Each note of the scale corresponds to a percussion instrument sound. In the S Series, the Drum Kits can be freely user-configured, by means of the Sound Patch. A series of Drum Kits are available as ROM Sounds.

Dry: Refers to the audio output signal from S Series not processed by the DSP. The Auxiliary outputs 1, 2, 3 and 4 always emit dry sounds.

DSP: (Digital Signal Processor). A chip contained in S Series which modifies the sound produced by the Oscillators, adding Reverb, Delay/Echo, and Modulations. Many different types of DSP units are commercially available, also known as *Multi Effects units*.

Edit: Modify. Refers to the entire Operating System of the S Series User Interface, and includes Edit Performance, Edit Sound, Edit Song, Edit General and Edit Effect.

Envelope: Term that graphically represents the change in the characteristics and quality of a Sound with time. In the S Series, this time lapse is applied to the programming of several elements that constitute the Sound: Intensity (Amplitude), Filters, Intonation (Pitch), Position within the Stereo Panorama (Pan).

Erase: Cancel, Eliminate. A command found within the Disk, Edit Performance and Edit Song environments. Destroys a set of data permanently (a Disk file, a Track, a part of a Song).

Expander: A modular Sound generating unit which operates as a Midi Slave device, requiring to be controlled by a controlling device such as a Master Keyboard, Midi keyboard, Midi Accordion, Wind controller, and others.

Filter: A device used to modify sounds by altering its harmonic content. The S Series uses two Filters for each voice, programming their development over time (Envelope), the cut-off frequency, the type of intervention (Band Pass, High Pass, Low Pass, Parametric Cut, Parametric Boost), and the intervention of Resonance Q.

Floppy Disk: A magnetic Data support. It consists of a disk, protected by a plastic container, in which data can be memorised - as in any other computer - in numeric form. The data can be created, restored, cancelled or updated at any moment.

Footswitch: A physical switch action controller operated with the foot. Two Footswitches can be connected to the S Series rear panel sockets and both are completely and independently programmable.

Headphones: Set of Stereo sound propagating devices that can be used for private listening. These are connected to S2/S3 by means of the appropriate socket located underneath the Wheels panel. In S2R, the socket is located on the front panel.

Import: A Sound Library function that permits a Sound to be copied from a Sound Library contained on a floppy disk or RAM-disk into the Sound Library of the instrument's RAM.

Load: A command found in the Disk environment. Copies data from a floppy disk into the Ram, and becomes available to be modified or used for other purposes (a Song, a Sound Library, a User Program...).

Loop: Cyclic repetition. A function found in the Edit Sound environment, used to repeat portions on Envelopes, and also in the Edit Sound environments, used to repeat a specified number of bars of a Song.

- Master Keyboard:** A controlling device (keyboard). Usually, a MK is a generator of MIDI events, incapable of generating Sounds. It is connected to the MIDI IN port of an external Sound generating device (an Expander), or another MIDI compatible musical instrument. The Master Keyboard's utility is its capacity of supplying advanced control functions, centralised in a single system of controllers. S2 and S3 can operate as advanced Master Keyboards, with functions such as Split, Merge and the programmability of the MIDI Controllers.
- Menu:** List of items. In Edit situations, you can access single functions or proceed to others from a list (menu) of different items, by moving the reverse-highlighted zone with the Dial and pressing Enter. In menus, each function or procedure corresponds to a number which, if specified on the numeric keypad, allows you to access the relative function directly.
- Merge:** See MIDI Merge.
- Microscope:** Refers to a particular function of the S Series Sequencer (Edit Song), in which every recorded MIDI event of a Track can be individually modified in terms of the song position as well as the value.
- MIDI:** (Musical Instrument Digital Interface). A system of communication between different digital musical instruments. MIDI is based on the connection via three types of ports: IN, OUT, THRU. The MIDI system renders all electronic digital instruments completely programmable at a distance (e.g. from a computer). The MIDI data provides the receiving instrument with all information necessary to produce sounds.
- MIDI Common:** A programmed MIDI channel to, (1) simulate the S2/S3 keyboards on a connected Master Keyboard, (2) send control messages (Bank/Song change, Performance change, Effect Change...) from an S-Series instrument to another instrument of the same series.
- MIDI Controllers:** MIDI messages which transmit information relating to performance parameters (Modulation, Main Volume, Damper Pedal...).
- MIDI Merge:** The function which "mixes" MIDI signals originating from different Sources, sent by the S Series MIDI processor to the MIDI OUT. In cases relating to signals arriving from a MIDI In Source, the MIDI processor acts as a redirecting device, given that a MIDI signal is usually directed to the MIDI THRU and not MIDI OUT.
- MIOS:** (Musical Instrument Operating System). Refers to the S Series Operating System, that is, the program that makes the instrument work. MIOS is resident in ROM and cannot be modified, but it can be expanded by means of User Programs.
- Modulation:** Dynamic modification over time. Modulation can affect Amplitude (Tremolo), Pitch (Vibrato) and the Filter. It is usually activated by the right Wheel or by After Touch.
- Move:** A function of the Sound Library and Effects Libraries that permits you to reconfigure the respective maps, by moving a Sound or Effect from its default position to another location.
- Multitasking:** The Operating System's capability of performing several operating tasks simultaneously without blocking the machine. The S Series Musical Instrument Operating System (MIOS) is Multitasking, because, for example, you can modify a Song while the Sequencer is in Playback mode, you can "freeze" the Edit Sound and access any other operating system ("Normal" or "Edit"), you can load or save a Song while listening to another Song...
- Normal:** The basic S Series operating environment. It includes all the Source section. It is the environment in which you can assign different Sounds to a Track and where you can select the four different playing modes, Single, Multi, Layer or Split for the Track configuration.
- Operating System:** See MIOS.
- Option:** A space predisposed for the functions implemented by User Programs.
- Oscillator:** The chip which produces the sound. The S Series utilises two oscillators per polyphonic voice. The oscillator reads a Waveform, which is then modified with Envelopes and Filters, in relation to Dynamic, After Touch and Pitch Bend messages etc., arriving from the S Series Controllers and from MIDI IN.
- Pan:** Abbreviation for Panorama. The Pan is the position of the Sound between two Stereo audio outputs.
- Pedal:** Programmable continuous physical controlling devices that can be connected to the appropriate sockets on the back panel of S2/S3.
- Performance:** The Track configuration that can be used by a song at any moment, or in a live situation.
- Pitch:** Intonation, frequency.
- Pitch Bend:** Dynamic modification of the intonation. Usually activated by the left Wheel of the S2 or S3 or by a MIDI Message.
- Playback:** The term that describes the Sequencer's capability of reproducing a Song. Also the name given to the display which is seen when you press the Song button in the Edit section.
- Preload:** "Background" Song loading while the Sequencer in playing another Song (the machine is not blocked by Preload).
- Program Change:** A MIDI Message which changes the Sound in a Track. The Program Change can be sent by the Data Entry section to the Internal Sound Generation, or sent via MIDI OUT to an external musical instrument. It can also be recorded in a Song.
- Quantize:** Correction of imperfect timing errors committed during Song recordings (including Rhythm patterns).
- RAM:** (Random Access Memory). A part of the S Series Memory which can be updated and in which new data can be loaded. The S Series are provided with 2 Megabytes of RAM dedicated to new Samples and 2 Megabytes of RAM dedicated to the operations performed by the microprocessor, the Bank/Songs, parts of the Setup (General, Sound Library, Effects Libraries, Clipboard) and to the User Programs. RAM memory is volatile, that is, it is cancelled when the instrument is switched off.
- RAM-disk:** A hard disk with high speed accessing possibilities, consisting of static RAM chips which retain their data after turning off the instrument. If installed, the S Series RAM-disk can have dimensions of 512 kb or 2 Mb.
- ROM:** (Read Only Memory). A part of the S Series memory which cannot be modified, and in which factory programmed data is conserved, such as the 518 ROM Sounds, the 209 Waveforms, the MIOS Operating System. ROM memory is not cancelled when the instrument is switched off.
- Sample:** Refers to a portion of the sound recorded in numeric form. The combination of several samples across various ranges of the scale is called a multi-sample. In the S Series, the multi-sample is called the Waveform and it forms the basis of the Sound, which assumes new Envelope and Filter information etc. during its stages of development.
- Save:** Memorize. This is a command found in the Disk environment as well as the Normal (Save Performance). Save renders all the modifications carried out to particular data permanent, or renders a set of data available for future use (a Song, a Sound Library...).
- Search:** The function found in the Sound Library which permits you to look for a Sound quickly by specifying two or more letters that are contained in the Sounds name.

Sequencer: A system of recording MIDI data. The Sequencer permits you to record a polyphonic song sound by sound, and so reproduce the song after carrying out any necessary corrections. The quality of a recording made with a Sequencer is maintained and does not decay, even after recording a large quantity of data and after many recordings: the Sequencer does not record sound, it records MIDI data.

Sliders: Controlling devices in the form of potentiometers, used for the Function Controllers group of the S2 and S3. S2R has software equivalents.

Song: A piece of music, recorded or reproduced (played back) by the Sequencer. The S Series can store 10 Songs in RAM, each one with its own Bank of 10 Performances.

Sound: In the S Series, the Sound is the final part of the multi-sampled element (Waveform) on which modifications of the Envelopes, Filters, Pan, etc. have been performed, in order to render the sound musically useful.
The Sounds are controlled by the Sound Library. 518 Sounds are in ROM, other can be loaded from floppy disk.

Sound Map: The configuration of the Sound in the Sound Library. Each Sound corresponds to a Program Change and Bank Select. The S Series Sound map can be remapped to correspond with other instruments of other manufacturers should they have different Sound maps.

Sound Patch: A layout of different sounds for each key, or two different sounds separated by a dynamic threshold. In the first case, sounds are assigned to various zones of the keyboard (maximum of 128 zones) and a typical use is a Drumkit. In the second case, two different Sounds can be assigned on two different dynamic levels, so that the second sound is triggered by varying the velocity (dynamics) with which a note is struck.

Source: A provider of MIDI events that can be directed to the S Series Tracks. The Sources are, the keyboard (local/Common), the MIDI In, the Sequencer (Song) and Option.

Store: Memorize. A command associated to the move command of the Sound Library and the Effects Libraries.

Track: A multitimbric part of a Song. A Track has its own programming and timbric characteristics. In the S Series, the Track is also the "elaborating centre" for MIDI data originating from the Sources (keyboard, MIDI In, Sequencer): this data is then redistributed to the destinations (internal Sound Generation, MIDI Out and Sequencer).

Transpose: The change in pitch (higher or lower) of a note with respect to a standard value.

Tweak: A term that describes the slight modification of one or more of a Sound's parameters.

User Interface: All that which appears within the Display. The means with which the user communicates with the musical instrument - that is, the availability of information relating to the status of the data - and in general with all computers. The S Series User Interface is a graphic system of superimposable windows containing parameters in graphical and text form.

Undo: Annul. A command available within the Edit environments that cancels the last performed task, or the last performed series of tasks. Undo can also cancel an undo operation, restoring an annulled task to its original status.

User: Generally, this term indicates all that can be programmed by the operator. For example, the User Controllers are the Function Controllers activated to operate in the mode programmed by the user.

User Programs: software programs that are loaded into the S Series RAM from a disk. These type of programs expand the Operating System and are commercially available through the normal Generalmusic channels of distribution. They are produced both by Generalmusic as well as external developers.

Waveform: In the S Series, the Waveform is always a multi-sample; the combination of several samples across different parts of the keyboard scale. A Sample is a portion of the sound recorded in numerical form. The Waveform is the Sound base which assumes particular characteristics by means of Envelope shaping, Filter programming, etc..

Wet: The term that is given to the audio signal directed to the Stereo Left/Right outputs processed by at least one of the two DSPs.

Wheels: The two controlling devices located on the extreme left of the control panel of the keyboard versions of the S Series (S2 and S3). In default conditions, they are set to provide Pitch Bend (Wheel 1/left) and Modulation (Wheel 2/right). The wheels are completely and independently programmable.

ALPHABETICAL INDEX

A

- Aftertouch
 - activation/deactivation 137, 138, 141
 - Balance control 148
 - Pan control 166
 - Pitch control 147, 148
 - Volume control 149
 - cutoff frequency control 155
 - Attack control 151
 - keyboard sensitivity 205
- Akai S1000 106, 112–114, 171
- Amplitude envelope 14. *See also* Envelopes (general info)
 - envelope finish 150
 - modifying via MIDI 101
 - tracking 152. *See also* Tracking (general info)
- Analog out. *See* Audio Outputs
- Append. *See* Edit Song: Append
- Attack. *See* Amplitude Envelope
- Audio outputs 28, 139
- Avalon 106, 111, 171

B

- Bank/Song 16, 72–74, 179
 - erasing from disk 216
 - erasing from memory 235
 - loading 53, 70, 214
 - copy 236
 - create 74, 180
 - modify name 235
 - save 57, 58, 215
 - select 45, 70
- Bank Select 96, 204, 221

C

- Catch locator 194, 198
- Chase Events 183
- Clipboard 234
 - cancel from memory 235
 - load. *See* Setup: loading
 - save. *See* Setup: save
- Clock 183. *See also* Song: Tempo
 - Clock Out 204
 - activation/deactivation 204
- Commands/options (general info) 22, 42
- Common Volume 182, 198
- Countdown 196. *See also* Song: recording: initial
 - countdown
- Cross-switch. *See* Tracks: dynamic limits
- Cut end 114
- Cutoff frequency. *See* Filters: cutoff frequency

D

- Date 205
- Decay. *See* Amplitude Envelope
- Delay (of the track) 17, 136, 141
- Destinations 18, 42, 126, 135–136
 - Internal generation 42, 126–128, 136–137, 139
 - Midi Out 42, 126–128, 136–137
- Detune (of the tracks). *See* Tracks: detune
- Detune of the Waveform (Detune of the oscillators). *See* Waveform: detune
- Dynamics
 - Balance control 148
 - Pan control 163, 166
 - Pitch envelope control 160
 - Volume control 149
 - Cutoff frequency control 155
 - Resonance control 155
 - Attack control 151
 - response curves 136
 - keyboard sensitivity 205
- Disk 209–220
 - Directory 211, 212
 - Erase
 - (all, single) 216
 - Format 52, 216
 - Load
 - (all, single) 214
 - load all 53
 - load all, automatic at power up 209
 - modify the name 217
 - Save
 - (all, single) 215
 - save all 57
- Drumkit 90, 176–178
- DSP. *See* Effects
- Dynamic curve. *See* Dynamics: response curves
- Dynamic range. *See* Tracks: dynamic limits

E

- Edit Effect 227–233
- Edit environment (general info) 21–25
- Edit General 201–208
- Edit Performance/Controls 44, 131–133
- Edit Performance/Tracks 44, 134–141
- Edit Song 184–200
 - "from locator... to locator..." 185
 - "note range" 185
- Append 192, 200
- Copy editor 191
- Dynamic editor 189
- Erase events editor 186
- Insert/delete bars editor 188
- Mastertrack editor 197

Microscope editor 193, 200
 Move events editor 187
 Quantize editor 190
 Transpose editor 189
 Utility editor 196
 Edit Sound 90–95, 142–168
 Amplitude envelope editor 150–153. *See also*
 Amplitude envelope
 Filter 1/2 editor 154–156
 Filter envelope editor 157–159
 LFO editor 153–154
 Pan editor 163–166
 Pitch envelope editor 160–162
 Volume editor 149–150
 Waveset editor 147–148
 saving the Sound to the SoundLibrary 144
 escape without saving 145
 Edit Stop To Bar 84, 182, 196, 200
 Eff. Bypass 41
 Effects 17, 79
 activation/deactivation 139
 recording 182, 198
 rotary 132, 198
 selection 131, 225
 via MIDI 100
 volume 131
 Effects Libraries 225–226
 loading. *See* Setup: loading
 saving. *See* Setup: saving
 Envelope (general information) 92–93
 Event list 193, 198, 200
 Extended Program Change. *See* MIDI Extended
 Program Change

F

F.C. reset 89, 132
 Family. *See* Sound Library: Sound families
 Filters 15, 91–92. *See also* Edit Sound: Filter 1/2
 editor
 cutoff frequency 91, 155
 envelope 92, 146
 modifying via MIDI 101
 out gain 155
 resonance 91, 155, 168
 filter types 167
 tracking 156
 tracking of the envelope 159
 Fine Pitch. *See* Waveform: Fine Pitch
 Floppy disk 19. *See also* Disk
 Footswitches 131, 132
 activation/deactivation 137, 138
 Start/Stop control, Perf+ and Perf- 203
 assignable MIDI messages 133
 polarity 203
 Formatting. *See* Disk: Format
 Free memory. *See* Song: Free memory
 Function Controller (S2R) 88–89, 132
 Function Controllers 44, 77, 86–88
 programming the User Keys 132

assignable MIDI messages 133
 programming the User Sliders 132
 assignable MIDI messages 133

G

Gain 106, 117, 146
 General Setup
 loading. *See* Setup: loading
 saving. *See* Setup: saving
 General MIDI 61, 206
 Group of Bank/Songs 19, 210
 loading from disk 216
 loading 54
 saving 58
 GS 61

I

Import 223–224
 Initialization. *See* Disk: Format
 Internal memory 19

J

Juke Box. *See* UTILITY: Juke Box

K

Key range. *See* Tracks: keyboard limits

L

Layer. *See* Tracks: track playing mode: layer
 LFO 94. *See also* Edit Sound: LFO editor
 applied to the filters 154
 applied to the pitch 153, 167
 applied to the amplitude 154, 167
 MIDI sync 153
 Load all. *See* Disk: Load: load all
 automatic at power up. *See* Disk: Load: Load all,
 automatic at power up
 Locator 84, 182
 Loop (of sample) 106, 117, 119, 120, 146. *See also*
 Sampling
 Loop (of Song). *See* Song loop

M

Master keyboard
 connection to S2R 29–30
 Master Track. *See* Edit Song: Mastertrack editor
 Master Transpose 129
 enable/disable 137
 Menu
 selection with Dial+Enter 39–40
 selection with numeric keypad 40
 Menu (general info) 22
 Metronome 182, 183, 196

Microscope. *See* Edit Song: Microscope editor

MIDI

compatibility General MIDI/GS. *See* General MIDI; GS

MIDI Channel lock 204, 208

MIDI Clock. *See* Clock

MIDI Extended Program Change 204

MIDI file 61–64

loading 62, 217

saving 63, 217

MIDI filters 139–140, 141

MIDI Merge 204

MIDI OFF 41

MIDI System Exclusive 204

MIDI-Common 29, 30, 98, 100, 137, 204

saving the editing 32

MMA sds (Sample Dump Standard) 110, 118, 171

Multi. *See* Tracks: Track playing mode: multi

Multisample 106. *See also* Waveform

Multitasking 20

Multitimbral 17

Mute 17, 44, 50, 77

"in mute" symbol 42, 82, 126–128

N

Normal 20

O

Oscillator. *See* Waveform

Outputs. *See* Audio outputs

Overdub. *See* Song: recording: replace/overdub

P

Pages (general info) 21

Pan 17, 94, 139

envelope 163

modifying via MIDI 101

tracking 165

Pan envelope. *See* Pan: envelope

Pan tracking. *See* Pan: tracking

PANIC 41

Parameters (general info) 22–23

Pedal Volume 182

Pedals 80, 131

activation/deactivation 137

assignable MIDI messages 133

recording 182, 198

Performance 16, 75–81

erase from memoria 235

copy 236

create 180

modify name 235

"Performance" viewing mode 43

"Save Performance" 44, 81, 89, 95

selection

from panell 43, 45

in a Song 179, 198

via MIDI 98

Pitch Bend 131, 132

Pitch envelope 166. *See also* Envelope (general info) tracking 162

Pitch envelope tracking. *See* Pitch envelope: tracking

Play 44, 50, 77

"in play" symbol 42, 82, 126–128

Playback. *See* Sequencer internal: controls; Song: playback

Poliphony 143

Preload 70, 237

Priority 139

Program Change 96, 204, 221

Q

Quantize. *See* Edit Song: Quantize editor; Song: Quantize

R

RAM-disk 19. *See also* Disk

RAM-Sounds. *See* Sounds: RAM-Sounds

Record. *See* Sequencer internal: controls; Song: recording

Release. *See* Amplitude Envelope

Replace. *See* Song: recording: replace/overdub

Resonance. *See* Filters: resonance

ROM-Sounds. *See* Sounds: ROM-Sounds

Rotary. *See* Effects: rotary

S

Sample 106

loading 109, 171

sending via MIDI 117, 173

Sample Vision 106, 111, 171

Sampling 14–15

Sampling rate 119

Save all. *See* Disk: Save: save all

Save Performance 44, 81, 89, 95

Scale 198, 201, 208

Sequencer external

connection to S2R 30–33

programming from S2/S3 102

Song exchange 183

Sequencer internal 70–71, 179–183

controlls 71, 180

Set split 49

Setup 19

erasing from disk 216

loading 53, 55, 214

saving 57, 59, 215

Source section 126–128

Single. *See* Tracks: playing mode: single

Solo 17, 50, 128, 170

Song 179–183, 183. *See also* Edit Song

erase from memory 72, 181

load. *See* Bank/Song: load

free memory 182

mastertrack 186
 playback 179
 quantize 84, 181
 recording 82–85, 83–85, 179, 181–182
 countdown 182
 Edit Stop To Bar 182
 Locator 182
 replace/overdub 182
 via MIDI 183
 selection. *See* Bank/Song: selection
 Tempo 84, 181, 182
 in the Mastertrack 198
 Time Signature 84, 181, 183
 tracks 82, 179
 Song loop 196
 Song Position Pointer 183
 Sound Library 91, 221–224
 load. *See* Setup: load
 save. *See* Setup: save
 Sound family 221
 Sound synthesis 14–15
 Sound Test 35, 206
 Sound Designer 106, 111, 171
 Sound Patch 90, 176–178
 Sounds
 load with "import" 223–224
 modify via MIDI 101
 RAM-Sounds 91
 ROM-Sounds 91
 selection
 from panel 43, 46
 via MIDI 96
 "Sounds" viewing mode 43
 type of Sounds 90, 111, 142
 selection in edit 146
 Sounds (general info) 15
 Sounds DC (Dual Crossfade). *See* Sounds: type of Sounds
 Sounds DO (Dual Oscillator). *See* Sounds: type of Sounds
 Sounds SO (Single Oscillator). *See* Sounds: type of Sounds
 Sources 18, 42, 48, 126–128, 135–136
 recording data generated by the S in a Song 82
 Split. *See* Tracks: playing mode: split
 Sustain. *See* Amplitude Envelope
 System Exclusive. *See* MIDI System Exclusive

T

Tempo. *See* Song: Tempo
 Time 205
 Time Signature. *See* Song: Time Signature
 Tracks
 assigning the Effects 80, 139
 assigning the Sounds 76

track playing modes 16, 43, 44, 48–49
 - resulting polyphony 143
 layer 48
 multi 49
 single 48
 split 48
 erase 75, 135, 141
 configuratoin of the tracks 17, 44, 135–136
 copy 76, 135
 correct track visualisation 47
 creation 75, 134
 of the Song 82
 detune 139
 Dynamic range 137, 138
 Key range 137, 138
 transpose 78, 136
 volume 77
 modify via MIDI 101
 Track Transposer 78, 129–130
 Tracking (general info) 93–94
 Transpose 78, 129–130
 True Events 183
 Tuning 201

U

UNDO 41, 182, 185, 196, 199, 200
 User Keys. *See* Function Controllers: programming
 the User Keys
 User Program 19
 load 214
 User Sliders. *See* Function Controllers: programming
 the User Sliders
 UTILITY 235–236
 Juke Box 235

V

Volume tracking 149. *See also* Tracking

W

Wave 106, 111, 171
 Waveform 15, 90, 91, 106, 108, 147, 148
 balance 148
 detune 120, 146, 147, 160, 166
 fine pitch 120, 148
 Wheels 80, 132
 activation/deactivation 137
 assignable MIDI messages 133

TROUBLESHOOTING

Problem	Possible cause	Solution
The instrument doesn't turn on.	The power cable is not inserted correctly.	Check the connection and make sure that the plug is inserted fully home.
The instrument (fitted with a Ram-disk) locks when you power up.	The data contained in the Ram-disk is damaged (probably due to a power failure during a previous "Save to Ram-disk" procedure.	Press ENTER an instant after turning on the instrument to exclude the Ram-disk. Access the Disk Erase operations and cancel the Ram-disk contents.
No sound is heard.	Check the amplifier and make sure it is turned on. If on, check the volume levels of the amplifier and instrument .	If the amplifier is off, turn it on. If the volume levels of one or both units are set to "zero", adjust them accordingly.
	The Tracks are not connected to the Keyboard source.	Configure the tracks of the Performance correctly for Local Source playing.
	You are playing (in Local/Common mode) on a section of the keyboard to which no sound has been assigned, or an incorrect transposition setting has taken the sound "out of range".	Check the remainder of the keyboard and adjust the keyboard range if necessary, or set the transposition to the correct value.
It is not possible to format a floppy disk.	The floppy disk is protected or damaged.	Remove the protection, or use a better quality disk.
	You are using an incorrectly formatted floppy (e.g. 3.5" DD "work" format).	Use a correctly formatted floppy (3.5" HD "work" format.
It is not possible to load the contents of a floppy disk into the instrument's memory.	The floppy may be an incorrect format for the load operation (Ms-Dos instead of S Series), or it could be damaged.	Use the correct loading procedure for the floppy in question (e.g. "Load Midi-File" for an Ms-Dos/Atari disk).
The Sequencer does not start when you press PLAY.	The clock is set to "External".	Set the Clock to "Internal", or start the sequencer by sending a start command from an external controlling device.
	An empty Bank/Song has been selected.	Select a Bank/Song which contains a Song.
MIDI communications are not possible.	The MIDI cables are incorrectly connected, or the tracks have not been assigned to the "Midi Out" destination.	Connect the Midi cables correctly and check that the tracks are connected to the "Midi Out" destination.
A note "locks" and cannot be stopped playing.	A MIDI error has occurred.	Press the PANIC button.

FEDERAL COMMUNICATIONS COMMISSION

Note: This equipment has been tested and found to comply with the limits for a Class B digital device, pursuant to Part 15 of FCC Rules. These limits are designed to provide reasonable protection against harmful interference in a residential installation. This equipment generates, uses, and can radiate radio frequency energy and, if not installed and used in accordance with the instructions, may cause harmful interference to radio communications. However, there is no guarantee that interference will not occur in a particular installation. If this instrument does cause harmful interference to radio or television reception, which can be determined by turning the instrument off and on, the user is encouraged to try to correct the interference by one or more of the following measures:

- Reorient or relocate the receiving antenna.
- Increase the separation between the equipment and the receiver.
- Connect the equipment into an outlet on a circuit different from that to which the receiver is connected.
- Consult the dealer or an experienced radio/TV technician for help.

CAUTION: Changes or modifications to this product not expressly approved by the manufacturer could void the user's authority to operate this product.

Specifications are subject to change without prior notice.

PRINTED IN ITALY



Sales Division: I -47048 S.Giovanni in Marignano (RN) - Italy – Via delle Rose, 12 Tel. +39 541 959511 – fax +39 541 957404
– tlx 550555 GMUSIC I - Internet: <http://www.generalmusic.com>